



scoop®, Pullbloc®, Pullbloc® 3.0, Pullbloc® 4.1, Slidebloc®, Slidebloc® 3.0, Slidebloc® 4.0, Slidebloc® light und formspiele® sind eingetragene Marken der scoop Beschläge Vertriebs-GmbH. Die in diesem Katalog enthaltenen Beschreibungen und Abbildungen entsprechen dem Zeitpunkt der Drucklegung. Für Druck- oder Satzfehler wird keine Haftung übernommen. Unsere Allgemeinen Geschäftsbedingungen finden Sie unter www.scoop-tec.de. Alle Rechte behalten wir uns vor.
© copyright: scoop Beschläge Vertriebs-GmbH. Gedruckt im April 2020.

Inhalt

| | | |
|--------------------------------|----|-----|
| Einleitung | ab | 4 |
| Kombinationsmöglichkeiten | ab | 20 |
| Schnellübersicht Formen | ab | 22 |
| Privat- und Objektbau GK3 | ab | 29 |
| Feuerschutzgarnituren | ab | 199 |
| Rosetten/Knöpfe/Schilder | ab | 213 |
| Glastürbeschläge | ab | 249 |
| Fenstergriffe | ab | 275 |
| Sicherheit | ab | 309 |
| Stoßgriffe | ab | 329 |
| Muschelgriffe | ab | 340 |
| Türstopper | ab | 345 |
| Türfixierer | ab | 347 |
| Hausnummern | ab | 348 |
| Buchstaben und Hinweisschilder | ab | 349 |

Kataloge und Broschüren zum Download unter www.scoop-tec.de

Pullbloc® Kugellagertechnik



Premiumklasse
Wohn- und Objektbau
Pullbloc® 3.0



Premiumklasse
Objektbau
Pullbloc® 4.1

scoop® Spezialsortimente



formspiele®



formspiele® dark



Slidebloc® Gleitlagertechnik

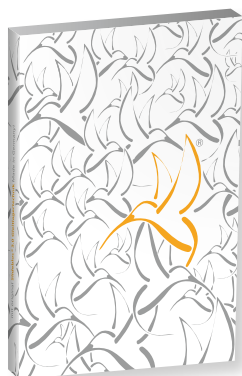

Topklasse Wohnbau
Slidebloc® 3.0



Topklasse Wohn- und Objektbau
Slidebloc® 4.0

scoop® Spezialsortimente



Qualitätsklasse Wohnbau
Slidebloc® light

Beste Qualität, bester Preis auch für den Privatbereich.

Made in Germany

Alle funktionsrelevanten Bauteile – die Kugellagertechnik **Pullbloc®** wie auch die Gleitlagertechnik **Slidebloc®** – werden an unserem Produktionsstandort in Fridolfing (Bayern) entwickelt und produziert. Dies ermöglicht uns eine lückenlose Qualitätskontrolle bei allen Komponenten und nach jedem einzelnen Produktionsvorgang. Achten Sie immer auf das Original!

Edelstahlteile

Sichtteile aus Edelstahl wie Drückerhandhaben, Deckrosetten oder dergleichen werden je nach Angebot weltweit in entsprechenden Produktionsstätten gefertigt. Die Vor-Ort-Qualitätskontrolle sichert unsere hohen technischen wie auch optischen Qualitätsansprüche.

Das Material

Die EDELSTAHL-Legierung „304“ ist besonders korrosionsbeständig und widerstandsfähig. Die Oberfläche hält härtester Beanspruchung stand. Aufgrund dieser Eigenschaften ist EDELSTAHL 304 ein idealer Werkstoff für Baubeschläge. Achten Sie bei EDELSTAHL-Produkten immer auf die Güteklasse! (Angaben nach AISI-Normen)



Best quality, best price also for the private domain.

Made in Germany

All functionally relevant components – the ball bearing technology **Pullbloc**[®] as well as the slide bearing technology **Slidebloc**[®] – are developed and produced at our production site in Fridolfing (Bavaria). This permits us to conduct a complete quality control for all components and after each individual production process. Always look for the original!

Stainless steel parts

Visible parts made of stainless steel, like handles, cover plates and such, are produced globally according to offer in the respective production sites. The on-site quality control ensures our high technical and optical quality requirements.

The material

The “304” stainless steel alloy is particularly corrosion-proof and durable. The surface withstands even the hardest strains. Due to these characteristics, stainless steel 304 is an ideal material for building fittings. Always pay attention to the quality grade of stainless steel products!
(information according to AISI standards)

Dauerhaft schön ist nur was dauerhaft funktioniert!

Jeden Tag, zu jeder Stunde, überall ...

Türgriffe sind so selbstverständlich, wir bemerken und sehen sie nicht mehr, obwohl wir sie jeden Tag, zu jeder Stunde überall auf unserer Welt unzählige Male betätigen. Erst, wenn sie nicht mehr funktionieren, fallen sie uns auf. Demzufolge ist die vorrangige Aufgabe eines Türgriffs, so lange wie nur möglich unbemerkt und unbeachtet zu bleiben. Für uns Grund genug Bewegungsmechanismen für unsere Garnituren zu finden, die genau diese Kriterien erfüllen.

Pullbloc®, **Slidebloc®** und **Slidebloc® light** arbeiten auch bei überdurchschnittlicher Beanspruchung verlässlich, lautlos, unbemerkt und dauerhaft.

Über Farbe, Form und Material sollte man nachdenken,

über dauerhafte Funktionsqualität niemals. Wer darauf wert legt, dass seine Türgriffe trotz optimaler und dauerhafter Funktion bemerkt und beachtet werden, sucht sich eine entsprechende Form auf den folgenden Seiten aus.



Permanent beauty implies permanent performance!

Every day, every hour, everywhere ...

Door handles are such a matter of course, we don't even notice and see them anymore although we use them every day, every hour, everywhere around the world countless times. Only when they don't work we become aware of them. Thus it is the chief task of a door handle to remain unnoticed and disregarded for as long as possible. Reason enough for us to find movement mechanisms for our handle sets which meet exactly these criteria.

Pullbloc®, **Slidebloc®** and **Slidebloc® light** work in a reliable, noiseless, unnoticed and permanent way even in case of strain above average.

We should consider colour, shape and material,

but never permanent functional quality. Those who put emphasize on the fact that their door handles are noticed and regarded despite an optimal and permanent function pick out the respective shape on the following pages.

Mehrwert ohne Mehrpreis! Sprechen Sie mit Ihrem Fachberater.

Keine Schneckenfeder, keine Flachfeder!

Diese sind nahezu in allen Türdrückergarnituren verbaut. Es ist kaum zu vermeiden, dass sich durch die Drehbewegung einzelne Windungen berühren und dabei aneinander reiben. Dies kann schon, nach nur wenigen Betätigungen, zu unerwünschten Kratzgeräuschen führen.



Kein dünner Kunststoffring als Drückerlagerung

zwischen Metallrosette und Drückerhandhabe!
Der markanteste Schwachpunkt marktüblicher Gleitlagern. Sie weisen Wandstärken von meist nur 0,5 mm auf und können sich schon nach nur kurzer Zeit durch die Reibung des Drückeransatzes durchscheuern. Die Folge kennt jeder, eine wackelige axiale Lagerung, welche die Funktion erheblich beeinträchtigt.

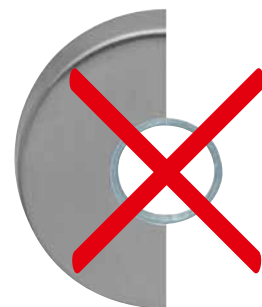



Die Pullbloc®-Kugellagertechnik!

Die neueste Generation der Drückerlagerung mit Rückstellung.

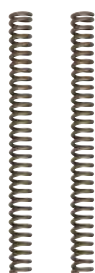

Druckfedern

aus hochwertigem Federstahl in Deutschland hergestellt! Laufruhig und gleichmäßig bringen sie dauerhaft den Drücker immer und immer wieder in die gewünschte Ursprungsposition.

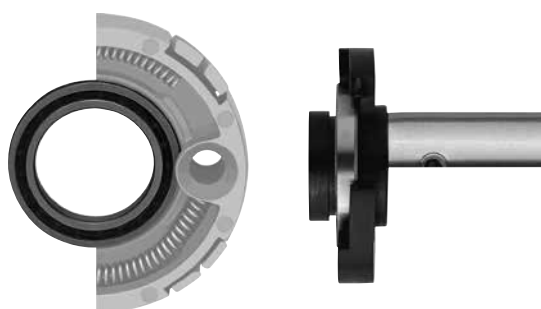

Original Pullbloc®-Kugellagertechnik!

Das Kugellager aus gehärtetem Stahl wurde genau für diese spezifischen Beanspruchungen erdacht und entwickelt. Dieses gewährleistet eine reibungsarme, lautlose Drehbewegung. Achten Sie immer auf die original **Pullbloc®**-Kugellagertechnik!

Additional value without additional price! Talk to your expert adviser.

No spiral spring, no flat spring!

These are integrated in almost every door handle set. It can hardly be avoided that individual windings touch due to the rotary movement and therefore produce friction. This may result in an unwanted scratching noise after pressing the handle only a few times.



No thin plastic ring as handle bearing

between metal cover plate and lever handle!
The most significant weak point of customary slide bearing sets. They have a thickness of at least 0.5 mm and can fray out even after a short time due to the friction of the handle projection. The result is known – a wobbly axial bearing which significantly affects the function.

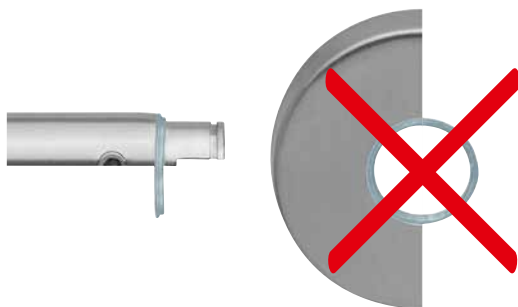



The Pullbloc® ball bearing system! The latest generation of handle bearing with return mechanism.

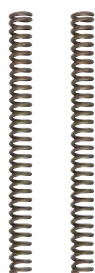

Compression springs

made of high-quality spring steel, produced in Germany! Running smoothly and uniformly, they steadily push the handle back into the required original position again and again.

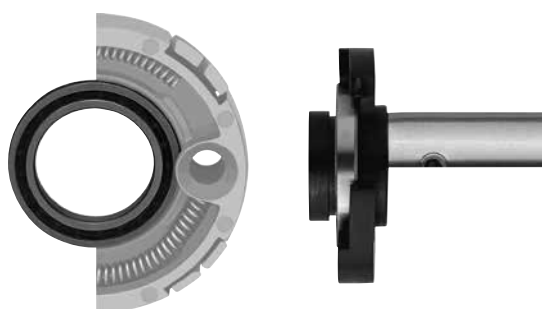

Original Pullbloc® ball bearing system!

The ball bearing of hardened steel was designed and developed particularly for these special strains. These guarantees a low-friction, noiseless rotary movement. Always look for the original **Pullbloc®** ball bearing system!

Technik im Detail

Die Stütznocken:

Erleichtern die Montage und verhindern das Verdrehen und Verrutschen an der Tür.

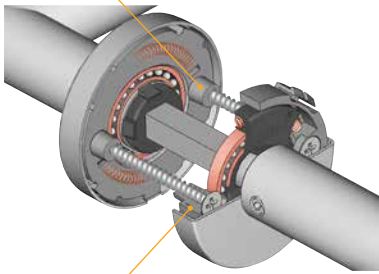

Die Montageelemente, die Basis:

Die Basis aus glasfaserverstärktem Polyamid besteht aus einem Guss und bietet dadurch die notwendige Statik. Sie ermöglichen gleichzeitig die Führung der Druckfedern und eine einwandfreie Klipverbindung mit der Deckrosette.

Gehärtete Stahl-Kugellager:

Die, direkt in die Basis eingepressten, **wartungsfreien Kugellager** aus gehärtetem Stahl, sorgen für die dauerhaft geschmeidige, wie auch geräuschlose Funktion.

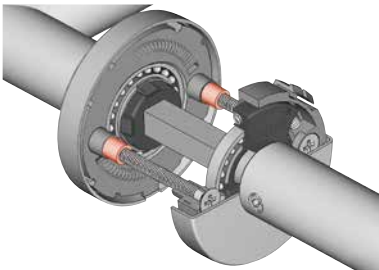

Die Bewegungselemente:

Die Verbindung zwischen Anker, Drücker und Vierkant ist **spielfrei**. Die Bewegung erfolgt gemeinsam, das verhindert jede Reibung am Drückeransatz und gewährleistet eine dauerhaft spielfreie, radiale wie axiale Führung der Drehbewegung. Der Anschlag nach oben verhindert ein Hochstehen des Drückers.

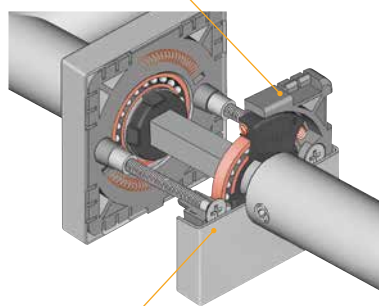

Die Rückstellelemente, die Federn:

Vier starke, vorgespannte **Druckfedern** schaffen konstanten Gegendruck von Beginn bis Ende jeder Betätigung und bringen die Drücker zuverlässig wieder in ihre Ursprungsposition.

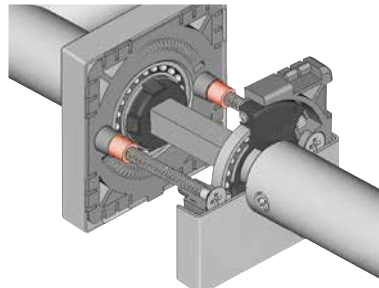

Verschraubung bei Türstärken ab 42 mm (Türstärken bei der Bestellung angeben): mit Gewindehülsen und M4 Verschraubung.



Technology in detail

The positioning studs:

Ease the installation and ensure a stable and durable connection to the door.

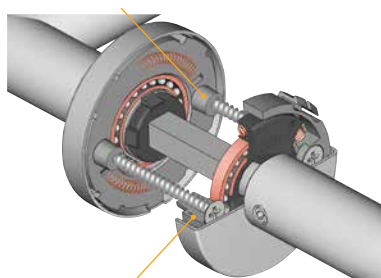

The mounting elements, the base:

The base made from glass-fibre reinforced polyamide is made in one piece and ensures the required static. It serves as guide for the compression springs and ensures a proper clip connection with the cover plates.

Hardened steel ball bearings:

The, pressed into the base, **maintenance-free ball bearings** made of hardened steel, guarantees a low-friction, noiseless rotary motion.

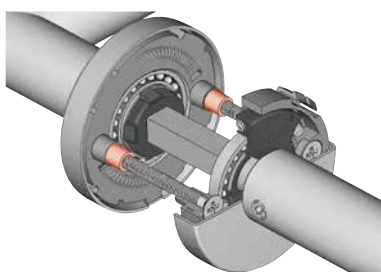

The motion elements:

The connection between anchor, handle and square bolt are **backlash-free**. They move together, which prevents any friction at the handle projection and ensures a permanently backlash-free radial and axial guide of the rotary movement. The upwards stop avoids that the handle stands up.

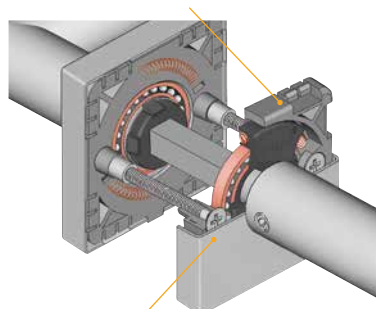

The restoring elements, the springs:

Four strong, pre-stressed **compression springs** create constant pressure from beginning to end of every single operation. Additional they return the handles back to their original position reliably.

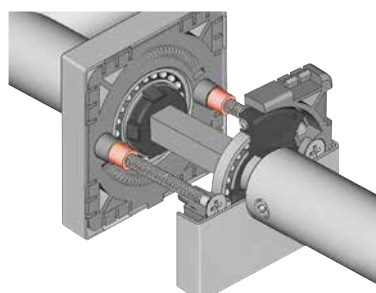

Screw connection for door **thicknesses from 42 mm** (specify the thicknesses of the door when ordering): with threaded sleeves and M4 screws..

Ehrliche, klare Argumente vereinfachen jede Beratung!

30 Jahre Garantie!

Über die gesetzliche Gewährleistung hinaus, erhalten Sie eine Garantie auf einwandfreie Funktion über 30 Jahre auf alle **Pullbloc®**-Kugellagersysteme!

Made in Germany!

Pullbloc® wurde in Deutschland entwickelt und wird in Deutschland produziert!

Langlebig und leise!

Das Kugellager aus gehärtetem Stahl sorgt für Langlebigkeit und Komfort. Durch die spielfreie Verbindung aller Komponenten ergeben sich keine Reibungspunkte. Keinerlei Abnutzung am **Drückeransatz**.

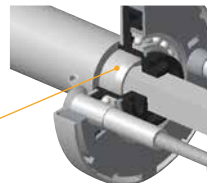

40 Sekunden Montage!

Pullbloc® wird weitgehend vormontiert geliefert. Die Montagezeit an der vorgebohrten Türe, Drücker- und Schlüsselrosetten beträgt nur 40 Sekunden!

Neu! Pullbloc® 3.0!

Bei der neuen **Pullbloc® 3.0**-Kugellagertechnik ist das Bewegungselement (der Anker) nicht mehr sichtbar und sorgt so für eine durchgängige Edelstahl-Optik.

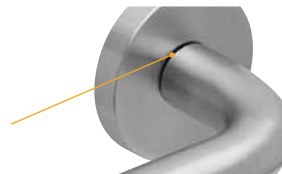

Jährliche Überwachung durch Prüfinstitute!

Funktion und Qualität von **Pullbloc®** werden von unabhängigen Prüfinstituten überwacht.

Das Patent!

Deutschland: DE 102005057766

Europa: EP 1793067

Alle genannten Informationen über Dauerhaftigkeit und Funktion sind durch ein unabhängiges Prüfinstitut geprüft und dokumentiert.



Honest, clear arguments simplify every consultation!

30 years of warranty!

Beyond statutory warranty, you get a warranty of perfect function over 30 years for all Pullbloc® ball bearing systems!

Made in Germany!

Pullbloc® has been designed in Germany and is produced in Germany!

Durable and noiseless!

The ball bearing of hardened steel provides durability and easy operation. Thanks to the backlash-free connection of all components, there are no points of friction. No wear of the **handle projection**.

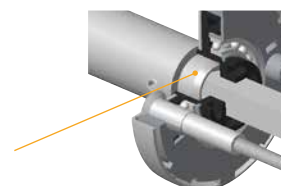

Assembled in 40 seconds!

Pullbloc® is delivered in a largely pre-assembled state. The assembly on the pre-drilled door, handle and key rosettes requires only 40 seconds!

New! Pullbloc® 3.0!

With the new Pullbloc® 3.0 ball bearing system, the motion element (the anchor) is no longer visible, thus ensures a consistent stainless steel look.

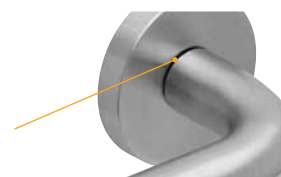

Annual monitoring by testing institutes!

Function and quality of Pullbloc® are monitored by independent testing institutes.

The patent!

Germany: DE 102005057766

Europe: EP 1793067

All mentioned information on durability and function is tested and documented by an independent testing institute.

Für die, die es interessiert!

Erklärung der DIN EN 1906

| Gebrauchskategorie | Dauerhaftigkeit | Türmasse | Feuerbeständigkeit | Sicherheit | Korrosion | Einbruchsicherheit | Ausführungsart |
|--------------------|-----------------|----------|--------------------|------------|------------|--------------------|----------------|
| 1-4 | 6-7 | – | 0/A-D | 0-1 | 0-5 | 0-4 | A/B/U |

Gebrauchskategorie:

Klasse 1

Zum Einsatz an Türen mit mittlerer Benutzungshäufigkeit durch Personen, die zu großer Sorgfalt motiviert sind und von denen ein geringes Risiko falscher Anwendung ausgeht (z. B. Innentüren von Wohnräumen).

Klasse 2

Zum Einsatz an Türen mit mittlerer Benutzungshäufigkeit durch Personen, die zur Sorgfalt motiviert sind, wobei jedoch ein gewisses Risiko falscher Anwendung besteht (z. B. Innentüren in Bürogebäuden).

Klasse 3

Zum Einsatz an Türen mit häufiger Benutzung durch Publikum oder andere Personen mit geringer Motivation zur Sorgfalt und bei denen ein hohes Risiko falscher Anwendung besteht (z. B. Türen in Bürogebäuden mit Publikumsverkehr).

Klasse 4

Zum Einsatz an Türen, die häufig Gewaltanwendungen oder Sachbeschädigungen ausgesetzt sind (z. B. Türen in Fußballstadien, auf Ölbohrinseln, in Kasernen oder öffentlichen Toiletten).

Dauerhaftigkeit:

Klasse 6

mittlere Benutzungshäufigkeit = 100.000 Prüfzyklen

Klasse 7

hohe Benutzungshäufigkeit = 200.000 Prüfzyklen

scoop® prüft Pullbloc® Bewegungsmechanismen für Türgriffe auf Dauerhaftigkeit nicht unter 1.000.000 Zyklen und mit erheblich höheren „Danach-Kriterien“ als es die DIN EN 1906 nach nur 200.000 Zyklen vorgibt.

Türmasse:

Keine Klassifizierung

Türmasse steht für das Gewicht der Türe.

Feuerbeständigkeit:

Mögliche Klassen:

0, A, A1, B, B1, C, C1, D oder D1

Klasse 0

nicht zulässig an Feuer- und Rauchschutztüren

Klasse A

geeignet für Rauchschutztüren

Klasse A1

geeignet für Rauchschutztüren (mit 200.000 Prüfzyklen an einer Prüftür geprüft)

Klasse B

geeignet für Rauch- und Feuerschutztüren (mit 200.000 Prüfzyklen geprüft)

Klasse B1

geeignet für Rauch- und Feuerschutztüren (mit 200.000 Prüfzyklen an einer Prüftür geprüft)

Klasse C

geeignet für Rauch- und Feuerschutztüren mit Anforderungen an Feuerschutzeinlagen in Schild, Türrosette und Schlüsselrosette

Klasse C1

geeignet für Rauch- und Feuerschutztüren mit Anforderungen an Feuerschutzeinlagen in Schild, Türrosette und Schlüsselrosette (mit 200.000 Prüfzyklen an einer Prüftür geprüft)

Klasse D

geeignet für Rauch- und Feuerschutztüren mit Anforderungen an einen Stahlkern im Griff

Klasse D1

geeignet für Rauch- und Feuerschutztüren mit Anforderungen an einen Stahlkern im Griff (mit 200.000 Prüfzyklen an einer Prüftür geprüft)

**Sicherheit:**

Klasse 0
normale Anforderung

Klasse 1
Sicherheitsanforderung

Sicherheit steht für die Gebrauchssicherheit unter erhöhter Belastung (Türdrücker die auch als Haltegriff verwendet werden oder für besonders schwere Türen, ...).

Korrosion:

Klasse 0
keine Festlegung

Klasse 1
gering

Klasse 2
mäßig

Klasse 3
hoch

Klasse 4
sehr hoch

Klasse 5
extrem hoch

Einbruchsicherheit:

Klasse 0
keine Leistung festgelegt

Klasse 1
gering einbruchhemmend
= DIN 18257 Widerstandskl. ES0

Klasse 2
mäßig einbruchhemmend
= DIN 18257 Widerstandskl. ES1

Klasse 3
stark einbruchhemmend
= DIN 18257 Widerstandskl. ES2

Klasse 4
extrem einbruchhemmend
= DIN 18257 Widerstandskl. ES3

Ausführungsart:

Ausführung A
mit Federunterstützung

Ausführung B
mit Federvorspannung

Ausführung U
ohne Federvorspannung

For those who would like to know!

Explanation of DIN EN 1906

| Category of use | Durability | Door mass | Fire resistance | Safety | Corrosion resistance | Security | Type of operation |
|-----------------|------------|-----------|-----------------|--------|----------------------|----------|-------------------|
| 1-4 | 6-7 | – | 0/A-D | 0-1 | 0-5 | 0-4 | A/B/U |

Category of use:

Class 1

For application on doors with medium frequency of use by persons with high incentive to exercise care and low chance of misuse (e.g. internal residential doors).

Class 2

For application on doors with medium frequency of use by persons with high incentive to exercise care, but some chance of misuse (e.g. internal office doors).

Class 3

For application on doors with high frequency of use by the public or others with little incentive to exercise care and high chance of misuse (e.g. public office doors).

Class 4

For application on doors frequently subject to violent use or damage (e.g. doors in soccer stadiums, on offshore oil rigs, in barracks or public restrooms).

Durability:

Class 6

Medium frequency of use = 100,000 test cycles

Class 7

High frequency of use = 200,000 test cycles

scoop® tests Pull-bloc® movement mechanisms for door handles for durability not below 1,000,000 cycles and with clearly higher "after criteria" as specified by DIN EN 1906 after only 200,000 cycles.

Door mass:

No classification

Door mass stands for the weight of the door.

Fire resistance:

Grades

0, A, A1, B, B1, C, C1, D or D1

Class 0

Not approved for use on fire/smoke door assemblies

Class A

Suitable for use on smoke door assemblies

Class A1

Suitable for use on smoke door assemblies (tested with 200,000 test cycles on a test door)

Class B

Suitable for use on fire/smoke door assemblies (tested with 200,000 test cycles)

Class B1

Suitable for use on fire/smoke door assemblies (tested with 200,000 test cycles on a test door)

Class C

Suitable for use on smoke and fire-resistant doors with requirements for fire-resistant dividers in backplate, door rose and escutcheon

Class C1

Suitable for use on smoke and fire-resistant doors with requirements for fire-resistant dividers in backplate, door rose and escutcheon (tested with 200,000 test cycles on a test door)

Class D

Suitable for use on fire/smoke door assemblies with require for a steel core in the handle

Class D1

Suitable for use on fire/smoke door assemblies with require for a steel core in the handle (tested with 200,000 test cycles on a test door)



Safety:

Class 0
Normal requirements

Class 1
Safety requirements

Safety stands for the safety of use under increased stress (door handle also used as strap or for particularly heavy doors, ...).

Corrosion resistance:

Class 0
Not defined

Class 1
Low

Class 2
Moderate

Class 3
High

Class 4
Very high

Class 5
Extra high

Security:

Class 0
No performance defined

Class 1
Low burglary resistance
= DIN 18257 resistance class
ES0

Class 2
Moderate burglary resistance
= DIN 18257 resistance class
ES1

Class 3
High burglary resistance
= DIN 18257 resistance class
ES2

Class 4
Extra high burglary resistance
= DIN 18257 resistance class
ES3

Type of operation:

Type A
spring-assisted

Type B
spring-loaded

Type U
unsprung

Kombinationsmöglichkeiten



**Rosetten
rund**
ab Seite 29

**Rosetten
Quadrat**
ab Seite 29

**Flächenbündige
Optik**
ab Seite 222

**Quadratrossetten
flach**
ab Seite 222



**Langschild
Standard**
ab Seite 236

**Kurzschild
Standard**
ab Seite 242

**Langschild
schmal**
ab Seite 236

**Kurzschild
schmal**
ab Seite 242

Schnellübersicht Formen auf Rundrosette

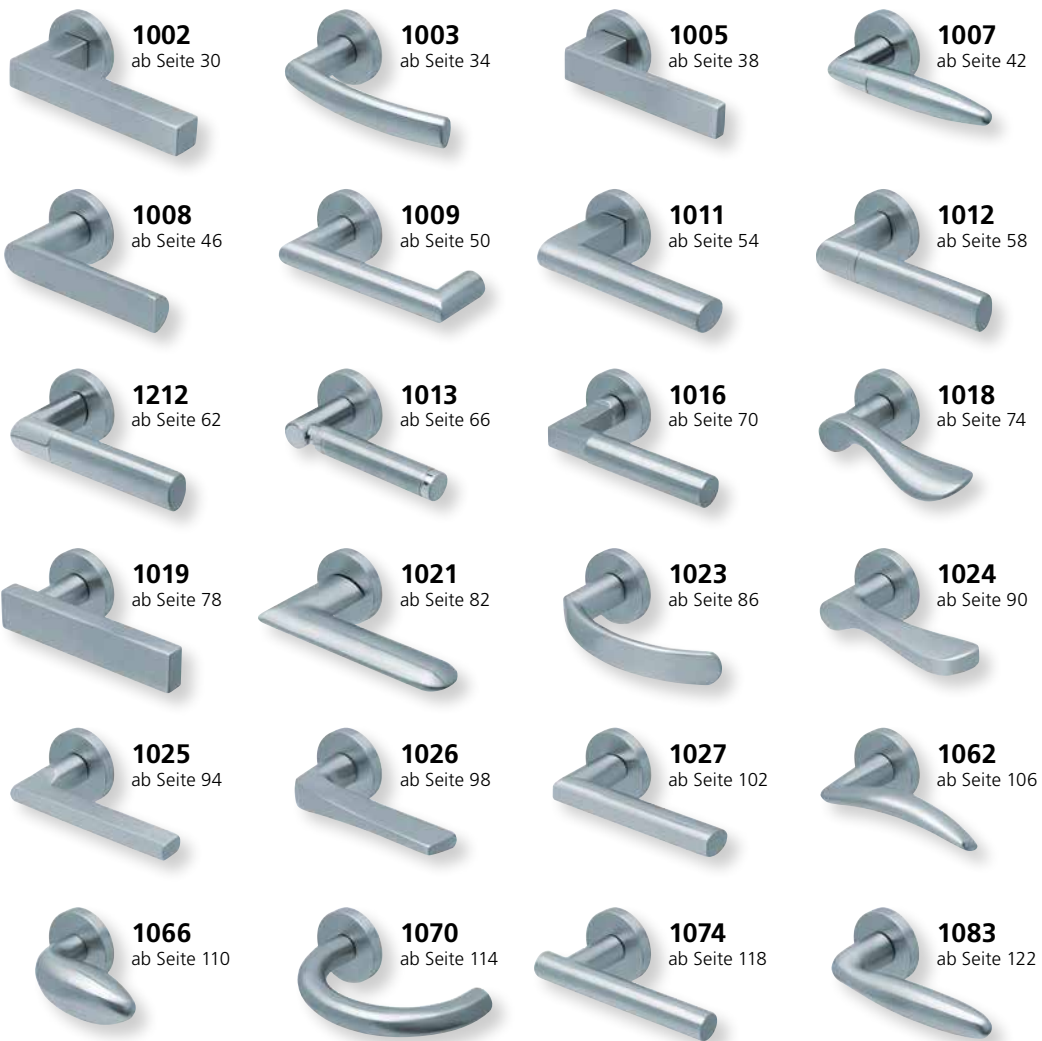



Schnellübersicht Formen auf Quadratrosette

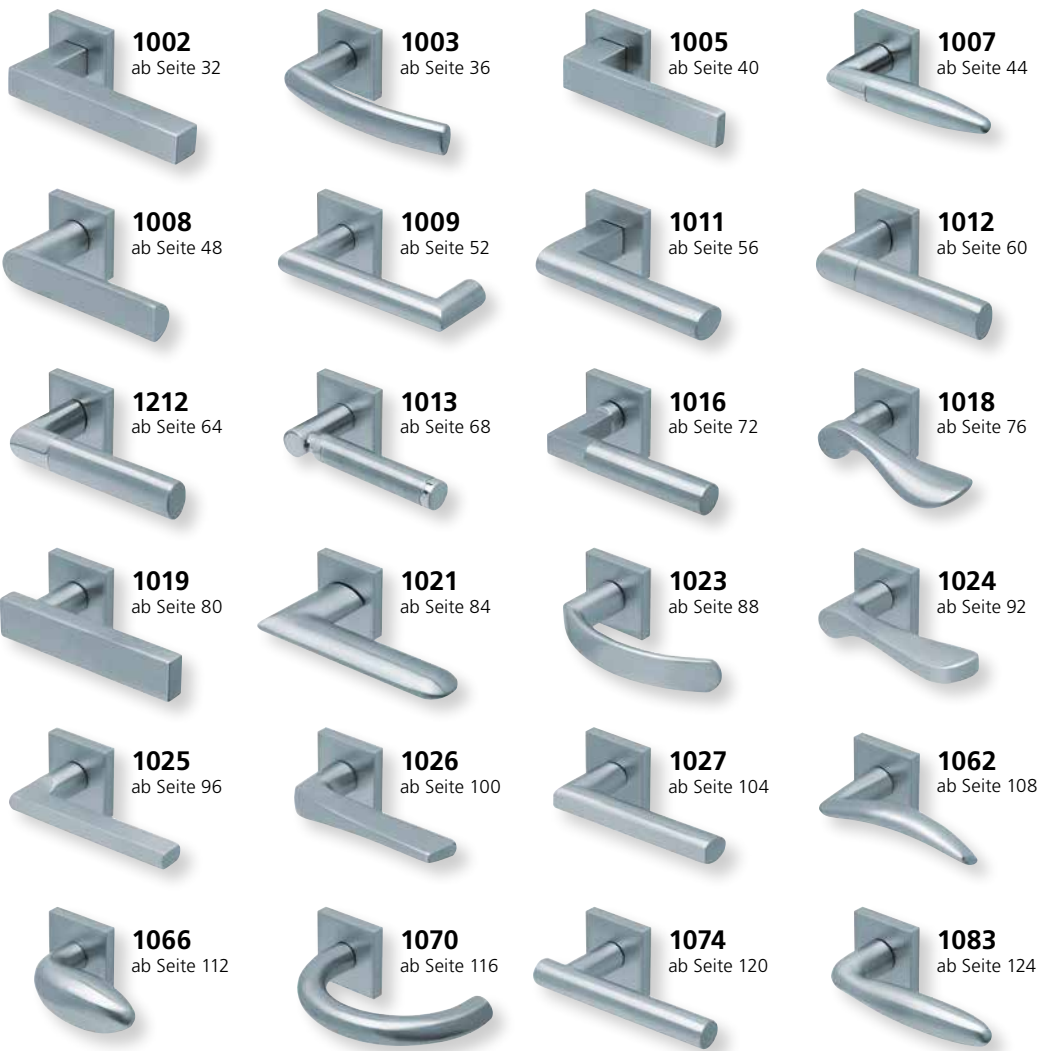



1084
ab Seite 128



1085
ab Seite 132



1100
ab Seite 136



1101
ab Seite 140



1103
ab Seite 144



1104
ab Seite 148



1106
ab Seite 152



1107
ab Seite 156



1108
ab Seite 160



1109
ab Seite 164



1173
ab Seite 168



1174
ab Seite 172



1200
ab Seite 176



1206
ab Seite 180



1275
ab Seite 184



1764
ab Seite 188



1765
ab Seite 192



1X74
ab Seite 196

Schnellübersicht Formen auf Rundrosette PVD Messinggelb



1002
ab Seite 30



1005
ab Seite 38



1008
ab Seite 46



1016
ab Seite 70



1018
ab Seite 74



1021
ab Seite 82



1024
ab Seite 90



1025
ab Seite 94



1026
ab Seite 98



1083
ab Seite 122



1084
ab Seite 126



1085
ab Seite 130



1103
ab Seite 142



Schnellübersicht Formen auf Quadratrosette PVD Messinggelb



Von Seite 29 bis Seite 197 finden Sie Türdrückergarnituren
zertifiziert nach **DIN EN 1906 GK3** laut folgendem Schlüssel.

| Gebrauchs- kategorie | Dauer- haftigkeit | Türmasse | Feuerbe- ständigkeit | Sicherheit | Korrosion | Einbruch- sicherheit | Ausfüh- rungsart |
|-------------------------|----------------------|----------|-------------------------|------------|-----------|-------------------------|---------------------|
| 3 | 7 | – | 0 | 0 | 4 | 0 | B |

Erklärung der **DIN EN 1906** auf den Seiten 16 und 17.

| | | |
|---------------------------|----|----|
| Einleitung | ab | 4 |
| Kombinationsmöglichkeiten | ab | 20 |
| Schnellübersicht Formen | ab | 22 |

Privat- und Objektbau GK3

| | | |
|--------------------------------|----|-----|
| Feuerschutzgarnituren | ab | 199 |
| Rosetten/Knöpfe/Schilder | ab | 213 |
| Glastürbeschläge | ab | 249 |
| Fenstergriffe | ab | 275 |
| Sicherheit | ab | 309 |
| Stoßgriffe | ab | 329 |
| Muschelgriffe | ab | 340 |
| Türstopper | ab | 345 |
| Türfixierer | ab | 347 |
| Hausnummern | ab | 348 |
| Buchstaben und Hinweisschilder | ab | 349 |



Drücker EDELSTAHL matt
Rosette EDELSTAHL matt



Drücker EDELSTAHL poliert
Rosette EDELSTAHL poliert

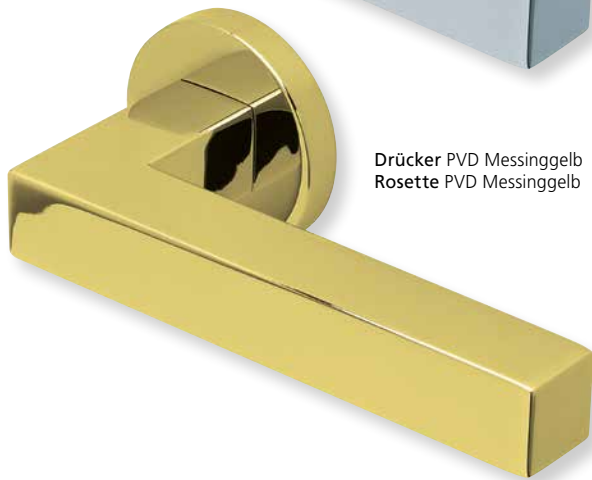

Drücker PVD Messinggelb
Rosette PVD Messinggelb

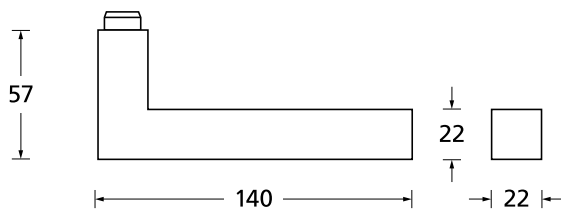



Pullbloc® 3.0 Kugellagertechnik

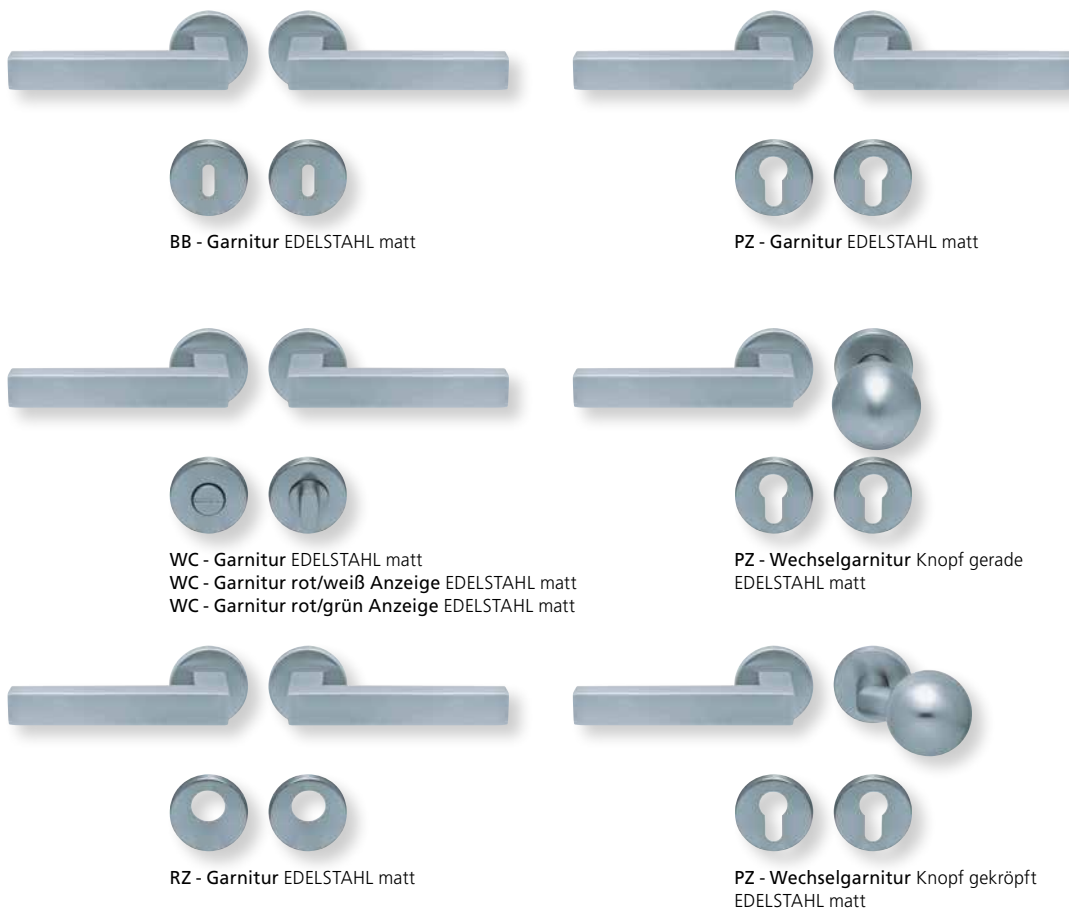

Form 1002 auf Rundrosette

| | Edelstahl matt | | Edelstahl poliert | | PVD Messinggelb | |
|---------------------------------------|-----------------|-------|-------------------|-------|--------------------|-------|
| | € exkl. MwSt. | | € exkl. MwSt. | | € exkl. MwSt. | |
| Rosettengarnitur | | | | | | |
| BB - Garnitur | PB3.0-10020 | 45,90 | PB3.0-P10020 | 55,90 | PB3.0-PVM10020 | 65,90 |
| PZ - Garnitur | PB3.0-10022 | 45,90 | PB3.0-P10022 | 55,90 | PB3.0-PVM10022 | 65,90 |
| OS - Garnitur (ohne Schlüsselrosette) | PB3.0-10020S | 41,90 | PB3.0-P10020S | 51,90 | PB3.0-PVM10020S | 61,90 |
| RZ - Garnitur | PB3.0-10028 | 45,90 | PB3.0-P10028 | 55,90 | PB3.0-PVM10028 | 65,90 |
| WC - Garnitur | PB3.0-10023 | 55,90 | PB3.0-P10023 | 65,90 | PB3.0-PVM10023 | 75,90 |
| WC - Garnitur rot/weiß Anz. | PB3.0-100231 | 59,90 | PB3.0-P100231 | 69,90 | PB3.0-PVM100231 | 79,90 |
| WC - Garnitur rot/grün Anz. | PB3.0-100232 | 59,90 | PB3.0-P100232 | 69,90 | PB3.0-PVM100232 | 79,90 |
| PZ-WG - Knopf ger. DIN R/L | PB3.0-10025/6 | 59,90 | PB3.0-P10025/6 | 69,90 | PB3.0-PVM10025/6 | 79,90 |
| PZ-WG - Knopf gekr. DIN R/L | PB3.0-100251/61 | 63,90 | PB3.0-P100251/61 | 73,90 | PB3.0-PVM100251/61 | 83,90 |
| Drückerpaar | | | | | | |
| ohne Rosetten | D10020 | 25,90 | DP10020 | 33,90 | DPVM10020 | 41,90 |

Standard-Türstärken: 38 - 42 mm
 Aufpreis für Türstärken ab 42 mm: € 5,00

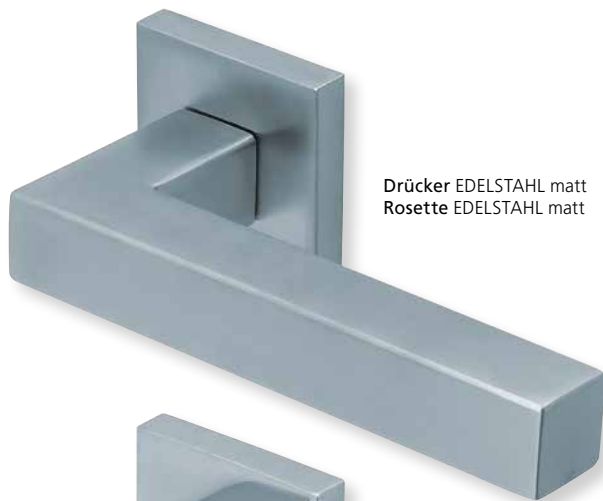

Drücker EDELSTAHL matt
Rosette EDELSTAHL matt



Drücker EDELSTAHL poliert
Rosette EDELSTAHL poliert

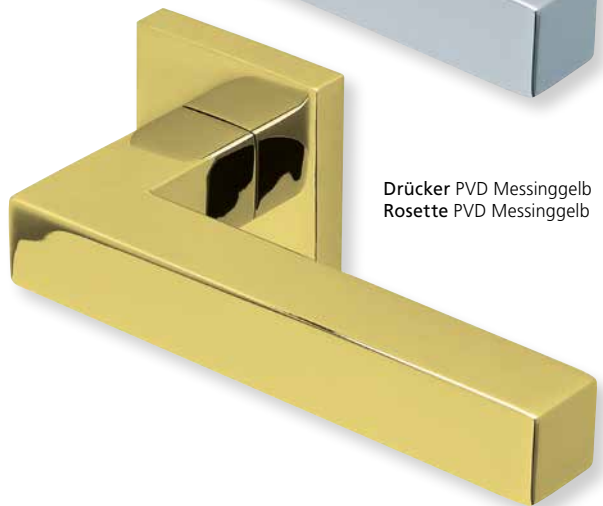

Drücker PVD Messinggelb
Rosette PVD Messinggelb

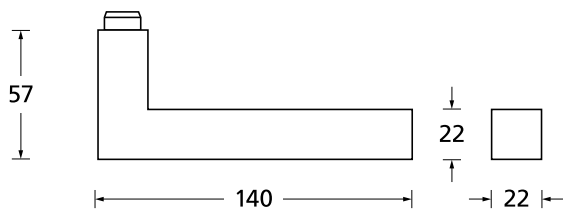



Pullbloc® 3.0 Kugellagertechnik

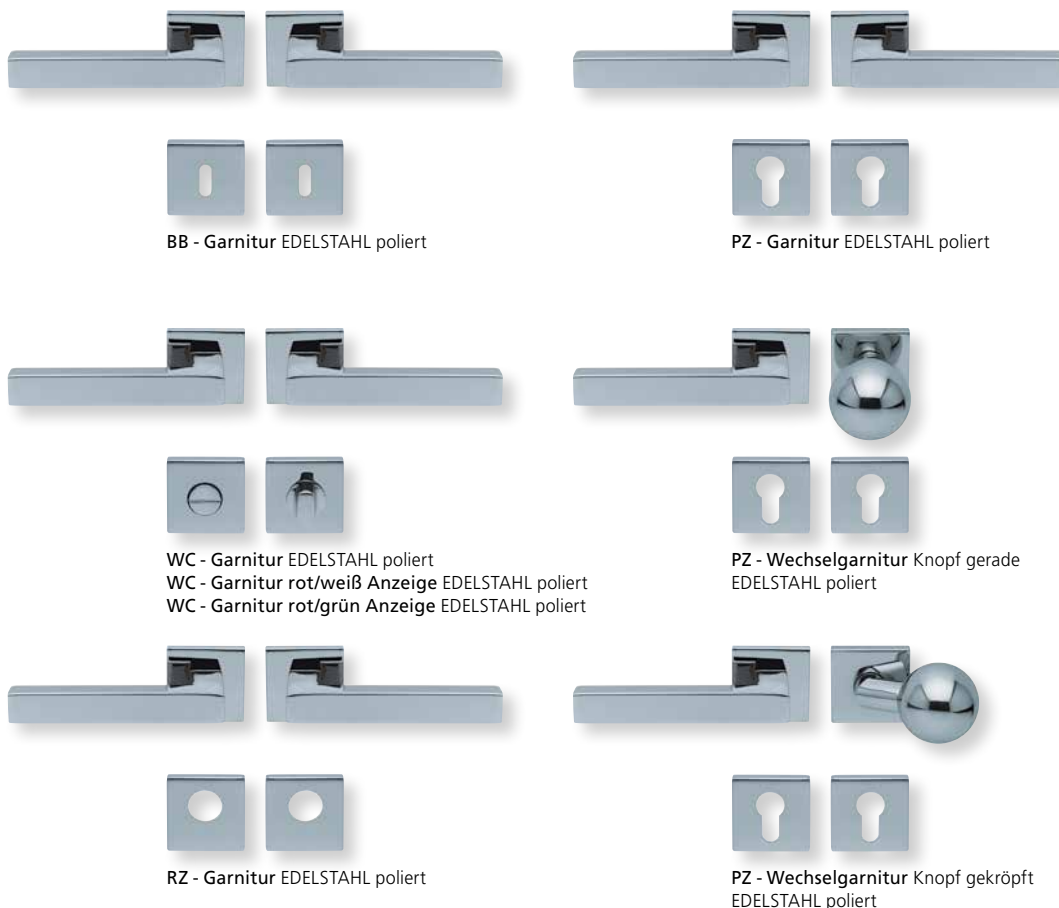

Form 1002 auf Quadratrosette

| | Edelstahl matt | | Edelstahl poliert | | PVD Messinggelb | |
|---------------------------------------|------------------|-------|-------------------|-------|---------------------|-------|
| | € exkl. MwSt. | | € exkl. MwSt. | | € exkl. MwSt. | |
| Rosettengarnitur | | | | | | |
| BB - Garnitur | PB3.0-Q10020 | 51,90 | PB3.0-QP10020 | 61,90 | PB3.0-QPVM10020 | 71,90 |
| PZ - Garnitur | PB3.0-Q10022 | 51,90 | PB3.0-QP10022 | 61,90 | PB3.0-QPVM10022 | 71,90 |
| OS - Garnitur (ohne Schlüsselrosette) | PB3.0-Q1002OS | 47,90 | PB3.0-QP1002OS | 57,90 | PB3.0-QPVM1002OS | 67,90 |
| RZ - Garnitur | PB3.0-Q10028 | 51,90 | PB3.0-QP10028 | 61,90 | PB3.0-QPVM10028 | 71,90 |
| WC - Garnitur | PB3.0-Q10023 | 61,90 | PB3.0-QP10023 | 71,90 | PB3.0-QPVM10023 | 81,90 |
| WC - Garnitur rot/weiß Anz. | PB3.0-Q100231 | 65,90 | PB3.0-QP100231 | 75,90 | PB3.0-QPVM100231 | 85,90 |
| WC - Garnitur rot/grün Anz. | PB3.0-Q100232 | 65,90 | PB3.0-QP100232 | 75,90 | PB3.0-QPVM100232 | 85,90 |
| PZ-WG - Knopf ger. DIN R/L | PB3.0-Q10025/6 | 65,90 | PB3.0-QP10025/6 | 75,90 | PB3.0-QPVM10025/6 | 85,90 |
| PZ-WG - Knopf gekr. DIN R/L | PB3.0-Q100251/61 | 69,90 | PB3.0-QP100251/61 | 79,90 | PB3.0-QPVM100251/61 | 89,90 |
| Drückerpaar | | | | | | |
| ohne Rosetten | D10020 | 25,90 | DP10020 | 33,90 | DPVM10020 | 41,90 |

Standard-Türstärken: 38 - 42 mm
 Aufpreis für Türstärken ab 42 mm: € 5,00



Drücker EDELSTAHL matt
Rosette EDELSTAHL matt



Drücker EDELSTAHL poliert
Rosette EDELSTAHL poliert

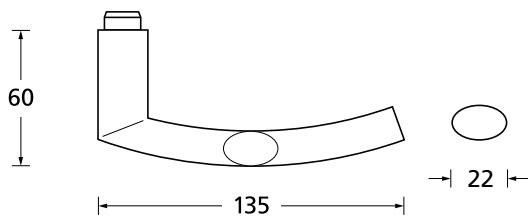



Pullbloc® 3.0 Kugellagertechnik

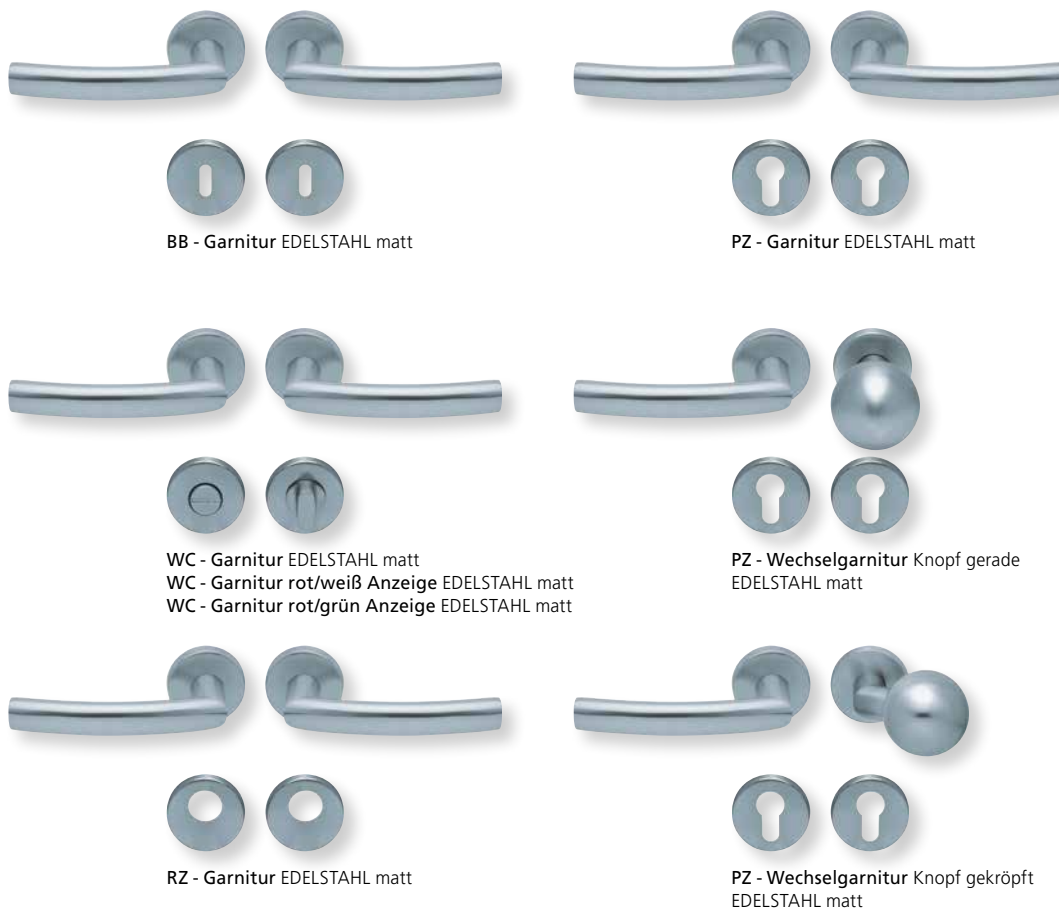

Form 1003 auf Rundrosette

| | Edelstahl matt | | Edelstahl poliert | |
|---------------------------------------|-----------------|---------------|-------------------|---------------|
| | | € exkl. MwSt. | | € exkl. MwSt. |
| Rosettengarnitur | | | | |
| BB - Garnitur | PB3.0-10030 | 45,90 | PB3.0-P10030 | 55,90 |
| PZ - Garnitur | PB3.0-10032 | 45,90 | PB3.0-P10032 | 55,90 |
| OS - Garnitur (ohne Schlüsselrosette) | PB3.0-1003OS | 41,90 | PB3.0-P1003OS | 51,90 |
| RZ - Garnitur | PB3.0-10038 | 45,90 | PB3.0-P10038 | 55,90 |
| WC - Garnitur | PB3.0-10033 | 55,90 | PB3.0-P10033 | 65,90 |
| WC - Garnitur rot/weiß Anz. | PB3.0-100331 | 59,90 | PB3.0-P100331 | 69,90 |
| WC - Garnitur rot/grün Anz. | PB3.0-100332 | 59,90 | PB3.0-P100332 | 69,90 |
| PZ-WG - Knopf ger. DIN R/L | PB3.0-10035/6 | 59,90 | PB3.0-P10035/6 | 69,90 |
| PZ-WG - Knopf gekr. DIN R/L | PB3.0-100351/61 | 63,90 | PB3.0-P100351/61 | 73,90 |
| Drückerpaar | | | | |
| ohne Rosetten | D10030 | 25,90 | DP10030 | 33,90 |

Standard-Türstärken: 38 - 42 mm
Aufpreis für Türstärken ab 42 mm: € 5,00



Drücker EDELSTAHL matt
Rosette EDELSTAHL matt



Drücker EDELSTAHL poliert
Rosette EDELSTAHL poliert

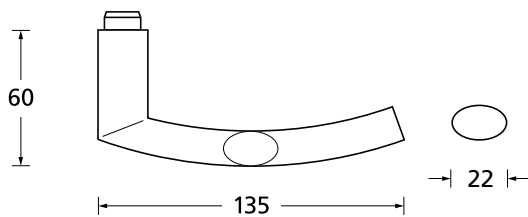



Pullbloc® 3.0 Kugellagertechnik



BB - Garnitur EDELSTAHL poliert



PZ - Garnitur EDELSTAHL poliert



WC - Garnitur EDELSTAHL poliert
WC - Garnitur rot/weiß Anzeige EDELSTAHL poliert
WC - Garnitur rot/grün Anzeige EDELSTAHL poliert



PZ - Wechselgarnitur Knopf gerade EDELSTAHL poliert



RZ - Garnitur EDELSTAHL poliert



PZ - Wechselgarnitur Knopf gekröpft EDELSTAHL poliert

Form 1003 auf Quadratrosette

| | Edelstahl matt | | Edelstahl poliert | |
|---------------------------------------|------------------|---------------|-------------------|---------------|
| | | € exkl. MwSt. | | € exkl. MwSt. |
| Rosettengarnitur | | | | |
| BB - Garnitur | PB3.0-Q10030 | 51,90 | PB3.0-QP10030 | 61,90 |
| PZ - Garnitur | PB3.0-Q10032 | 51,90 | PB3.0-QP10032 | 61,90 |
| OS - Garnitur (ohne Schlüsselrosette) | PB3.0-Q1003OS | 47,90 | PB3.0-QP1003OS | 57,90 |
| RZ - Garnitur | PB3.0-Q10038 | 51,90 | PB3.0-QP10038 | 61,90 |
| WC - Garnitur | PB3.0-Q10033 | 61,90 | PB3.0-QP10033 | 71,90 |
| WC - Garnitur rot/weiß Anz. | PB3.0-Q100331 | 65,90 | PB3.0-QP100331 | 75,90 |
| WC - Garnitur rot/grün Anz. | PB3.0-Q100332 | 65,90 | PB3.0-QP100332 | 75,90 |
| PZ-WG - Knopf ger. DIN R/L | PB3.0-Q10035/6 | 65,90 | PB3.0-QP10035/6 | 75,90 |
| PZ-WG - Knopf gekr. DIN R/L | PB3.0-Q100351/61 | 69,90 | PB3.0-QP100351/61 | 79,90 |
| Drückerpaar | | | | |
| ohne Rosetten | D10030 | 25,90 | DP10030 | 33,90 |

Standard-Türstärken: 38 - 42 mm
Aufpreis für Türstärken ab 42 mm: € 5,00



Drücker EDELSTAHL matt
Rosette EDELSTAHL matt



Drücker EDELSTAHL poliert
Rosette EDELSTAHL poliert



Drücker PVD Messinggelb
Rosette PVD Messinggelb

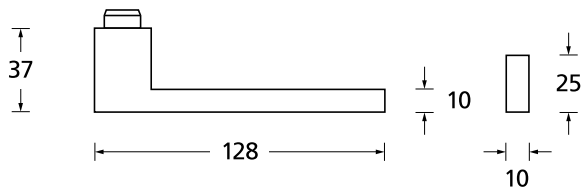



Pullbloc® 3.0 Kugellagertechnik



BB - Garnitur EDELSTAHL matt



PZ - Garnitur EDELSTAHL matt



WC - Garnitur EDELSTAHL matt
WC - Garnitur rot/weiß Anzeige EDELSTAHL matt
WC - Garnitur rot/grün Anzeige EDELSTAHL matt



PZ - Wechselgarnitur Knopf gerade
EDELSTAHL matt



RZ - Garnitur EDELSTAHL matt



PZ - Wechselgarnitur Knopf gekröpft
EDELSTAHL matt

Form 1005 auf Rundrosette

| | Edelstahl matt | | Edelstahl poliert | | PVD Messinggelb | |
|---------------------------------------|-----------------|-------|-------------------|-------|--------------------|-------|
| | € exkl. MwSt. | | € exkl. MwSt. | | € exkl. MwSt. | |
| Rosettengarnitur | | | | | | |
| BB - Garnitur | PB3.0-10050 | 51,90 | PB3.0-P10050 | 61,90 | PB3.0-PVM10050 | 71,90 |
| PZ - Garnitur | PB3.0-10052 | 51,90 | PB3.0-P10052 | 61,90 | PB3.0-PVM10052 | 71,90 |
| OS - Garnitur (ohne Schlüsselrosette) | PB3.0-10050S | 47,90 | PB3.0-P10050S | 57,90 | PB3.0-PVM10050S | 67,90 |
| RZ - Garnitur | PB3.0-10058 | 51,90 | PB3.0-P10058 | 61,90 | PB3.0-PVM10058 | 71,90 |
| WC - Garnitur | PB3.0-10053 | 61,90 | PB3.0-P10053 | 71,90 | PB3.0-PVM10053 | 81,90 |
| WC - Garnitur rot/weiß Anz. | PB3.0-100531 | 65,90 | PB3.0-P100531 | 75,90 | PB3.0-PVM100531 | 85,90 |
| WC - Garnitur rot/grün Anz. | PB3.0-100532 | 65,90 | PB3.0-P100532 | 75,90 | PB3.0-PVM100532 | 85,90 |
| PZ-WG - Knopf ger. DIN R/L | PB3.0-10055/6 | 65,90 | PB3.0-P10055/6 | 75,90 | PB3.0-PVM10055/6 | 85,90 |
| PZ-WG - Knopf gekr. DIN R/L | PB3.0-100551/61 | 69,90 | PB3.0-P100551/61 | 79,90 | PB3.0-PVM100551/61 | 89,90 |
| Drückerpaar | | | | | | |
| ohne Rosetten | D10050 | 29,90 | DP10050 | 37,90 | DPVM10050 | 45,90 |

Standard-Türstärken: 38 - 42 mm
Aufpreis für Türstärken ab 42 mm: € 5,00

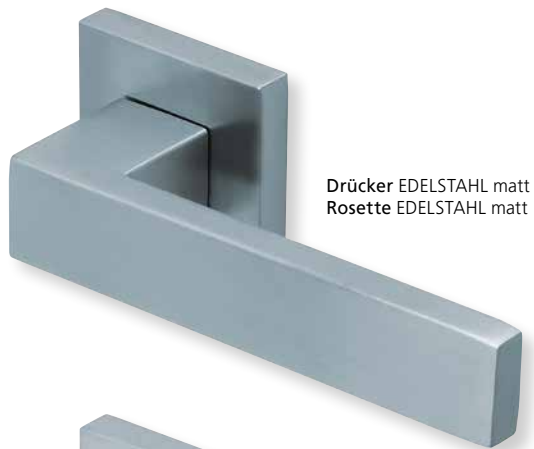

Drücker EDELSTAHL matt
Rosette EDELSTAHL matt

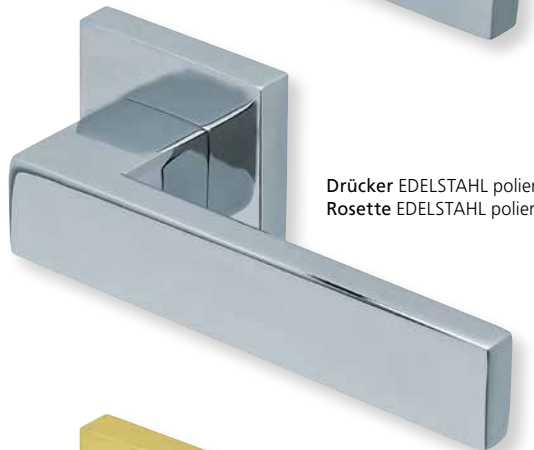

Drücker EDELSTAHL poliert
Rosette EDELSTAHL poliert

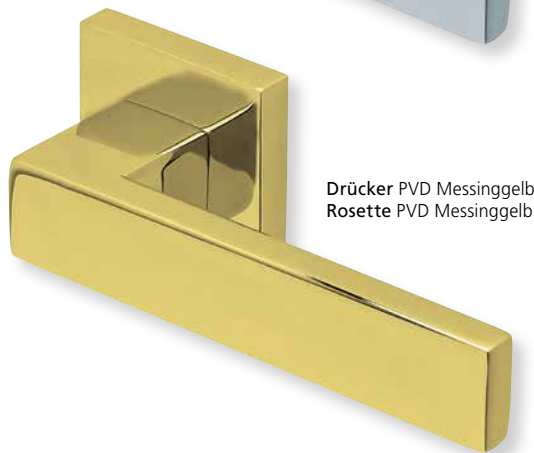

Drücker PVD Messinggelb
Rosette PVD Messinggelb

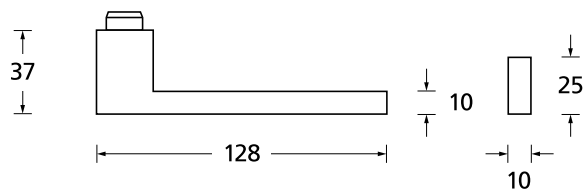



Pullbloc® 3.0 Kugellagertechnik



BB - Garnitur EDELSTAHL poliert



PZ - Garnitur EDELSTAHL poliert



WC - Garnitur EDELSTAHL poliert
WC - Garnitur rot/weiß Anzeige EDELSTAHL poliert
WC - Garnitur rot/grün Anzeige EDELSTAHL poliert



PZ - Wechselgarnitur Knopf gerade EDELSTAHL poliert



RZ - Garnitur EDELSTAHL poliert



PZ - Wechselgarnitur Knopf gekröpft EDELSTAHL poliert

Form 1005 auf Quadratrosette

| | Edelstahl matt | | Edelstahl poliert | | PVD Messinggelb | |
|---------------------------------------|------------------|-------|-------------------|-------|---------------------|-------|
| | € exkl. MwSt. | | € exkl. MwSt. | | € exkl. MwSt. | |
| Rosettengarnitur | | | | | | |
| BB - Garnitur | PB3.0-Q10050 | 57,90 | PB3.0-QP10050 | 67,90 | PB3.0-QPVM10050 | 77,90 |
| PZ - Garnitur | PB3.0-Q10052 | 57,90 | PB3.0-QP10052 | 67,90 | PB3.0-QPVM10052 | 77,90 |
| OS - Garnitur (ohne Schlüsselrosette) | PB3.0-Q10050S | 53,90 | PB3.0-QP10050S | 63,90 | PB3.0-QPVM10050S | 73,90 |
| RZ - Garnitur | PB3.0-Q10058 | 57,90 | PB3.0-QP10058 | 67,90 | PB3.0-QPVM10058 | 77,90 |
| WC - Garnitur | PB3.0-Q10053 | 67,90 | PB3.0-QP10053 | 77,90 | PB3.0-QPVM10053 | 87,90 |
| WC - Garnitur rot/weiß Anz. | PB3.0-Q100531 | 71,90 | PB3.0-QP100531 | 81,90 | PB3.0-QPVM100531 | 91,90 |
| WC - Garnitur rot/grün Anz. | PB3.0-Q100532 | 71,90 | PB3.0-QP100532 | 81,90 | PB3.0-QPVM100532 | 91,90 |
| PZ-WG - Knopf ger. DIN R/L | PB3.0-Q10055/6 | 71,90 | PB3.0-QP10055/6 | 81,90 | PB3.0-QPVM10055/6 | 91,90 |
| PZ-WG - Knopf gekr. DIN R/L | PB3.0-Q100551/61 | 75,90 | PB3.0-QP100551/61 | 85,90 | PB3.0-QPVM100551/61 | 95,90 |
| Drückerpaar | | | | | | |
| ohne Rosetten | D10050 | 29,90 | DP10050 | 37,90 | DPVM10050 | 45,90 |

Standard-Türstärken: 38 - 42 mm
Aufpreis für Türstärken ab 42 mm: € 5,00



Drücker EDELSTAHL poliert/EDELSTAHL matt
Rosette EDELSTAHL matt



Drücker EDELSTAHL poliert/EDELSTAHL matt
Rosette EDELSTAHL poliert

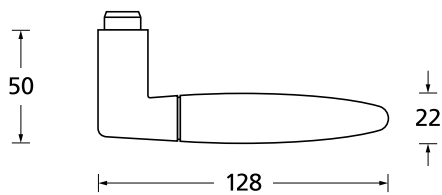



Pullbloc® 3.0 Kugellagertechnik



BB - Garnitur EDELSTAHL poliert



PZ - Garnitur EDELSTAHL poliert



WC - Garnitur EDELSTAHL poliert
WC - Garnitur rot/weiß Anzeige EDELSTAHL poliert
WC - Garnitur rot/grün Anzeige EDELSTAHL poliert



PZ - Wechselgarnitur Knopf gerade EDELSTAHL poliert



RZ - Garnitur EDELSTAHL poliert



PZ - Wechselgarnitur Knopf gekröpft EDELSTAHL poliert

Form 1007 auf Rundrosette

| | Edelstahl matt | | Edelstahl poliert | |
|---------------------------------------|-----------------|---------------|-------------------|---------------|
| | | € exkl. MwSt. | | € exkl. MwSt. |
| Rosettengarnitur | | | | |
| BB - Garnitur | PB3.0-10070 | 51,90 | PB3.0-P10070 | 57,90 |
| PZ - Garnitur | PB3.0-10072 | 51,90 | PB3.0-P10072 | 57,90 |
| OS - Garnitur (ohne Schlüsselrosette) | PB3.0-1007OS | 47,90 | PB3.0-P1007OS | 53,90 |
| RZ - Garnitur | PB3.0-10078 | 51,90 | PB3.0-P10078 | 57,90 |
| WC - Garnitur | PB3.0-10073 | 61,90 | PB3.0-P10073 | 67,90 |
| WC - Garnitur rot/weiß Anz. | PB3.0-100731 | 65,90 | PB3.0-P100731 | 71,90 |
| WC - Garnitur rot/grün Anz. | PB3.0-100732 | 65,90 | PB3.0-P100732 | 71,90 |
| PZ-WG - Knopf ger. DIN R/L | PB3.0-10075/6 | 65,90 | PB3.0-P10075/6 | 71,90 |
| PZ-WG - Knopf gekr. DIN R/L | PB3.0-100751/61 | 69,90 | PB3.0-P100751/61 | 75,90 |
| Drückerpaar | | | | |
| ohne Rosetten | D10070 | 29,90 | D10070 | 29,90 |

Standard-Türstärken: 38 - 42 mm
Aufpreis für Türstärken ab 42 mm: € 5,00



Drücker EDELSTAHL poliert/EDELSTAHL matt
Rosette EDELSTAHL matt



Drücker EDELSTAHL poliert/EDELSTAHL matt
Rosette EDELSTAHL poliert

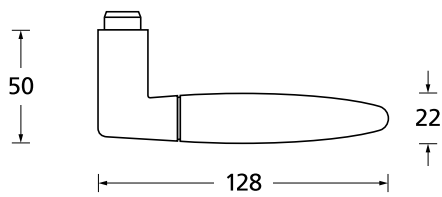



Pullbloc® 3.0 Kugellagertechnik



BB - Garnitur EDELSTAHL poliert



PZ - Garnitur EDELSTAHL poliert



WC - Garnitur EDELSTAHL poliert
WC - Garnitur rot/weiß Anzeige EDELSTAHL poliert
WC - Garnitur rot/grün Anzeige EDELSTAHL poliert



PZ - Wechselgarnitur Knopf gerade EDELSTAHL poliert



RZ - Garnitur EDELSTAHL poliert



PZ - Wechselgarnitur Knopf gekröpft EDELSTAHL poliert

Form 1007 auf Quadratrosette

| | Edelstahl matt | | Edelstahl poliert | |
|---------------------------------------|------------------|---------------|-------------------|---------------|
| | | € exkl. MwSt. | | € exkl. MwSt. |
| Rosettengarnitur | | | | |
| BB - Garnitur | PB3.0-Q10070 | 57,90 | PB3.0-QP10070 | 63,90 |
| PZ - Garnitur | PB3.0-Q10072 | 57,90 | PB3.0-QP10072 | 63,90 |
| OS - Garnitur (ohne Schlüsselrosette) | PB3.0-Q1007OS | 53,90 | PB3.0-QP1007OS | 59,90 |
| RZ - Garnitur | PB3.0-Q10078 | 57,90 | PB3.0-QP10078 | 63,90 |
| WC - Garnitur | PB3.0-Q10073 | 67,90 | PB3.0-QP10073 | 73,90 |
| WC - Garnitur rot/weiß Anz. | PB3.0-Q100731 | 71,90 | PB3.0-QP100731 | 77,90 |
| WC - Garnitur rot/grün Anz. | PB3.0-Q100732 | 71,90 | PB3.0-QP100732 | 77,90 |
| PZ-WG - Knopf ger. DIN R/L | PB3.0-Q10075/6 | 71,90 | PB3.0-QP10075/6 | 77,90 |
| PZ-WG - Knopf gekr. DIN R/L | PB3.0-Q100751/61 | 75,90 | PB3.0-QP100751/61 | 81,90 |
| Drückerpaar | | | | |
| ohne Rosetten | D10070 | 29,90 | D10070 | 29,90 |

Standard-Türstärken: 38 - 42 mm
Aufpreis für Türstärken ab 42 mm: € 5,00



Drücker EDELSTAHL matt
Rosette EDELSTAHL matt



Drücker EDELSTAHL poliert
Rosette EDELSTAHL poliert



Drücker PVD Messinggelb
Rosette PVD Messinggelb

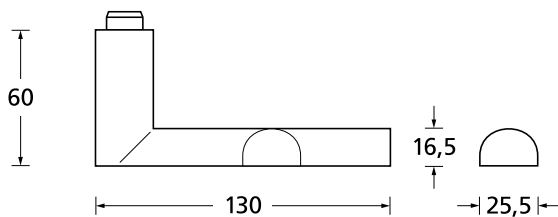



Pullbloc® 3.0 Kugellagertechnik

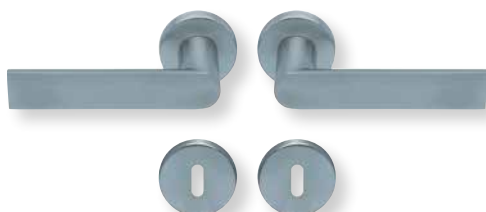

BB - Garnitur EDELSTAHL matt

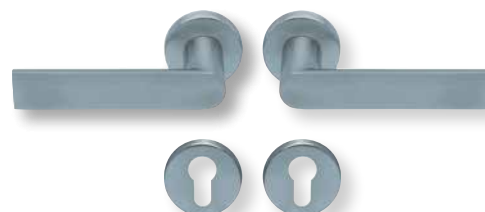

PZ - Garnitur EDELSTAHL matt



WC - Garnitur EDELSTAHL matt
WC - Garnitur rot/weiß Anzeige EDELSTAHL matt
WC - Garnitur rot/grün Anzeige EDELSTAHL matt

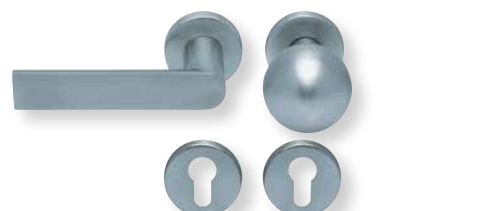

PZ - Wechselgarnitur Knopf gerade EDELSTAHL matt

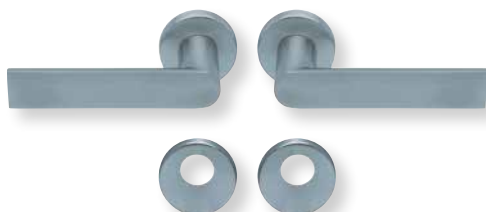

RZ - Garnitur EDELSTAHL matt

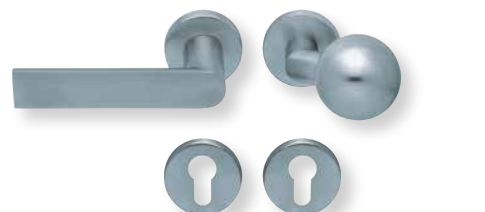

PZ - Wechselgarnitur Knopf gekröpft EDELSTAHL matt

Form 1008 auf Rundrosette

| | Edelstahl matt | | Edelstahl poliert | | PVD Messinggelb | |
|---------------------------------------|-----------------|-------|-------------------|-------|--------------------|-------|
| | € exkl. MwSt. | | € exkl. MwSt. | | € exkl. MwSt. | |
| Rosettengarnitur | | | | | | |
| BB - Garnitur | PB3.0-10080 | 45,90 | PB3.0-P10080 | 55,90 | PB3.0-PVM10080 | 65,90 |
| PZ - Garnitur | PB3.0-10082 | 45,90 | PB3.0-P10082 | 55,90 | PB3.0-PVM10082 | 65,90 |
| OS - Garnitur (ohne Schlüsselrosette) | PB3.0-1008OS | 41,90 | PB3.0-P1008OS | 51,90 | PB3.0-PVM1008OS | 61,90 |
| RZ - Garnitur | PB3.0-10088 | 45,90 | PB3.0-P10088 | 55,90 | PB3.0-PVM10088 | 65,90 |
| WC - Garnitur | PB3.0-10083 | 55,90 | PB3.0-P10083 | 65,90 | PB3.0-PVM10083 | 75,90 |
| WC - Garnitur rot/weiß Anz. | PB3.0-100831 | 59,90 | PB3.0-P100831 | 69,90 | PB3.0-PVM100831 | 79,90 |
| WC - Garnitur rot/grün Anz. | PB3.0-100832 | 59,90 | PB3.0-P100832 | 69,90 | PB3.0-PVM100832 | 79,90 |
| PZ-WG - Knopf ger. DIN R/L | PB3.0-10085/6 | 59,90 | PB3.0-P10085/6 | 69,90 | PB3.0-PVM10085/6 | 79,90 |
| PZ-WG - Knopf gekr. DIN R/L | PB3.0-100851/61 | 63,90 | PB3.0-P100851/61 | 73,90 | PB3.0-PVM100851/61 | 83,90 |
| Drückerpaar | | | | | | |
| ohne Rosetten | D10080 | 25,90 | DP10080 | 33,90 | DPVM10080 | 41,90 |

Standard-Türstärken: 38 - 42 mm
Aufpreis für Türstärken ab 42 mm: € 5,00

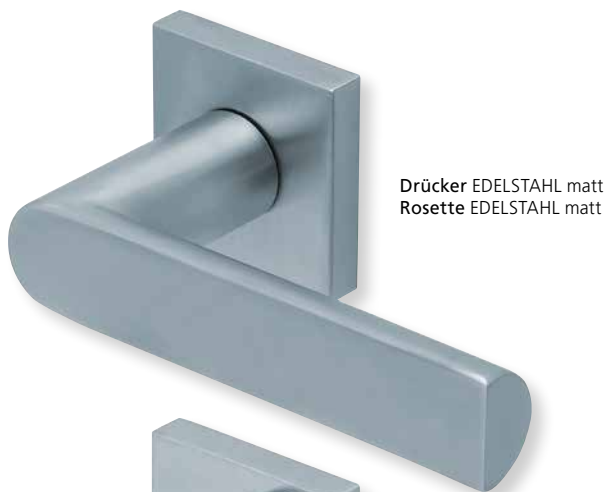

Drücker EDELSTAHL matt
Rosette EDELSTAHL matt



Drücker EDELSTAHL poliert
Rosette EDELSTAHL poliert



Drücker PVD Messinggelb
Rosette PVD Messinggelb

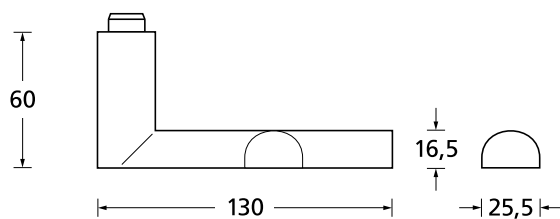



Pullbloc® 3.0 Kugellagertechnik



BB - Garnitur EDELSTAHL poliert



PZ - Garnitur EDELSTAHL poliert



WC - Garnitur EDELSTAHL poliert
WC - Garnitur rot/weiß Anzeige EDELSTAHL poliert
WC - Garnitur rot/grün Anzeige EDELSTAHL poliert



PZ - Wechselgarnitur Knopf gerade EDELSTAHL poliert



RZ - Garnitur EDELSTAHL poliert



PZ - Wechselgarnitur Knopf gekröpft EDELSTAHL poliert

Form 1008 auf Quadratrosette

| | Edelstahl matt | | Edelstahl poliert | | PVD Messinggelb | |
|---------------------------------------|------------------|---------------|-------------------|---------------|---------------------|---------------|
| | | € exkl. MwSt. | | € exkl. MwSt. | | € exkl. MwSt. |
| Rosettengarnitur | | | | | | |
| BB - Garnitur | PB3.0-Q10080 | 51,90 | PB3.0-QP10080 | 61,90 | PB3.0-QPVM10080 | 71,90 |
| PZ - Garnitur | PB3.0-Q10082 | 51,90 | PB3.0-QP10082 | 61,90 | PB3.0-QPVM10082 | 71,90 |
| OS - Garnitur (ohne Schlüsselrosette) | PB3.0-Q1008OS | 47,90 | PB3.0-QP1008OS | 57,90 | PB3.0-QPVM1008OS | 67,90 |
| RZ - Garnitur | PB3.0-Q10088 | 51,90 | PB3.0-QP10088 | 61,90 | PB3.0-QPVM10088 | 71,90 |
| WC - Garnitur | PB3.0-Q10083 | 61,90 | PB3.0-QP10083 | 71,90 | PB3.0-QPVM10083 | 81,90 |
| WC - Garnitur rot/weiß Anz. | PB3.0-Q100831 | 65,90 | PB3.0-QP100831 | 75,90 | PB3.0-QPVM100831 | 85,90 |
| WC - Garnitur rot/grün Anz. | PB3.0-Q100832 | 65,90 | PB3.0-QP100832 | 75,90 | PB3.0-QPVM100832 | 85,90 |
| PZ-WG - Knopf ger. DIN R/L | PB3.0-Q10085/6 | 65,90 | PB3.0-QP10085/6 | 75,90 | PB3.0-QPVM10085/6 | 85,90 |
| PZ-WG - Knopf gekr. DIN R/L | PB3.0-Q100851/61 | 69,90 | PB3.0-QP100851/61 | 79,90 | PB3.0-QPVM100851/61 | 89,90 |
| Drückerpaar | | | | | | |
| ohne Rosetten | D10080 | 25,90 | DP10080 | 33,90 | DPVM10080 | 41,90 |

Standard-Türstärken: 38 - 42 mm
Aufpreis für Türstärken ab 42 mm: € 5,00



Drücker EDELSTAHL matt
Rosette EDELSTAHL matt



Drücker EDELSTAHL poliert
Rosette EDELSTAHL poliert

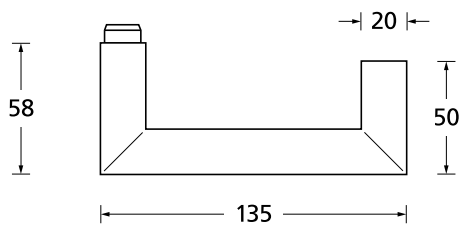



Pullbloc® 3.0 Kugellagertechnik



BB - Garnitur EDELSTAHL matt



PZ - Garnitur EDELSTAHL matt



WC - Garnitur EDELSTAHL matt
WC - Garnitur rot/weiß Anzeige EDELSTAHL matt
WC - Garnitur rot/grün Anzeige EDELSTAHL matt



PZ - Wechselgarnitur Knopf gerade EDELSTAHL matt



RZ - Garnitur EDELSTAHL matt

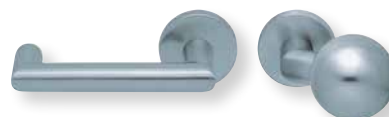

PZ - Wechselgarnitur Knopf gekröpft EDELSTAHL matt

Form 1009 auf Rundrosette

| Rosettengarnitur | Edelstahl matt | | Edelstahl poliert | |
|---------------------------------------|-----------------|---------------|-------------------|---------------|
| | | € exkl. MwSt. | | € exkl. MwSt. |
| BB - Garnitur | PB3.0-10090 | 45,90 | PB3.0-P10090 | 55,90 |
| PZ - Garnitur | PB3.0-10092 | 45,90 | PB3.0-P10092 | 55,90 |
| OS - Garnitur (ohne Schlüsselrosette) | PB3.0-1009OS | 41,90 | PB3.0-P1009OS | 51,90 |
| RZ - Garnitur | PB3.0-10098 | 45,90 | PB3.0-P10098 | 55,90 |
| WC - Garnitur | PB3.0-10093 | 55,90 | PB3.0-P10093 | 65,90 |
| WC - Garnitur rot/weiß Anz. | PB3.0-100931 | 59,90 | PB3.0-P100931 | 69,90 |
| WC - Garnitur rot/grün Anz. | PB3.0-100932 | 59,90 | PB3.0-P100932 | 69,90 |
| PZ-WG - Knopf ger. DIN R/L | PB3.0-10095/6 | 59,90 | PB3.0-P10095/6 | 69,90 |
| PZ-WG - Knopf gekr. DIN R/L | PB3.0-100951/61 | 63,90 | PB3.0-P100951/61 | 73,90 |
| Drückerpaar | | | | |
| ohne Rosetten | D10090 | 25,90 | DP10090 | 33,90 |

Standard-Türstärken: 38 - 42 mm
Aufpreis für Türstärken ab 42 mm: € 5,00



Drücker EDELSTAHL matt
Rosette EDELSTAHL matt



Drücker EDELSTAHL poliert
Rosette EDELSTAHL poliert

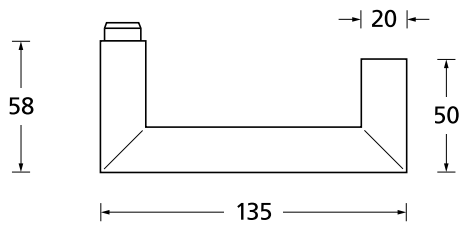



Pullbloc® 3.0 Kugellagertechnik



BB - Garnitur EDELSTAHL poliert



PZ - Garnitur EDELSTAHL poliert



WC - Garnitur EDELSTAHL poliert
WC - Garnitur rot/weiß Anzeige EDELSTAHL poliert
WC - Garnitur rot/grün Anzeige EDELSTAHL poliert



PZ - Wechselgarnitur Knopf gerade EDELSTAHL poliert



RZ - Garnitur EDELSTAHL poliert



PZ - Wechselgarnitur Knopf gekröpft EDELSTAHL poliert

Form 1009 auf Quadratrosette

| | Edelstahl matt | | Edelstahl poliert | |
|---------------------------------------|------------------|---------------|-------------------|---------------|
| | | € exkl. MwSt. | | € exkl. MwSt. |
| Rosettengarnitur | | | | |
| BB - Garnitur | PB3.0-Q10090 | 51,90 | PB3.0-QP10090 | 61,90 |
| PZ - Garnitur | PB3.0-Q10092 | 51,90 | PB3.0-QP10092 | 61,90 |
| OS - Garnitur (ohne Schlüsselrosette) | PB3.0-Q1009OS | 47,90 | PB3.0-QP1009OS | 57,90 |
| RZ - Garnitur | PB3.0-Q10098 | 51,90 | PB3.0-QP10098 | 61,90 |
| WC - Garnitur | PB3.0-Q10093 | 61,90 | PB3.0-QP10093 | 71,90 |
| WC - Garnitur rot/weiß Anz. | PB3.0-Q100931 | 65,90 | PB3.0-QP100931 | 75,90 |
| WC - Garnitur rot/grün Anz. | PB3.0-Q100932 | 65,90 | PB3.0-QP100932 | 75,90 |
| PZ-WG - Knopf ger. DIN R/L | PB3.0-Q10095/6 | 65,90 | PB3.0-QP10095/6 | 75,90 |
| PZ-WG - Knopf gekr. DIN R/L | PB3.0-Q100951/61 | 69,90 | PB3.0-QP100951/61 | 79,90 |
| Drückerpaar | | | | |
| ohne Rosetten | D10090 | 25,90 | DP10090 | 33,90 |

Standard-Türstärken: 38 - 42 mm
Aufpreis für Türstärken ab 42 mm: € 5,00

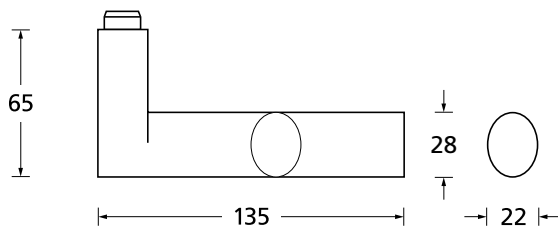
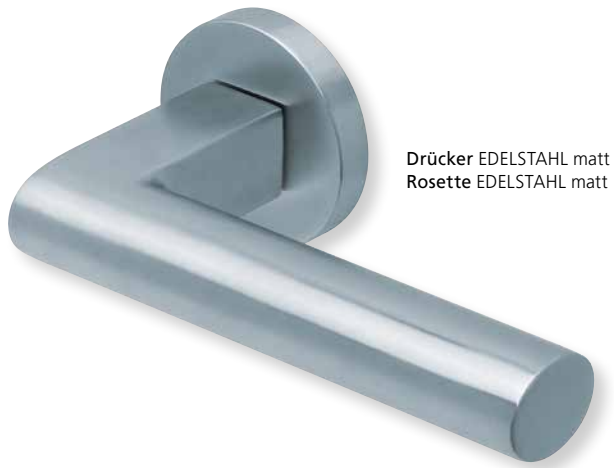



Pullbloc® 3.0 Kugellagertechnik



BB - Garnitur EDELSTAHL matt



PZ - Garnitur EDELSTAHL matt



WC - Garnitur EDELSTAHL matt
WC - Garnitur rot/weiß Anzeige EDELSTAHL matt
WC - Garnitur rot/grün Anzeige EDELSTAHL matt



PZ - Wechselgarnitur Knopf gerade EDELSTAHL matt



RZ - Garnitur EDELSTAHL matt

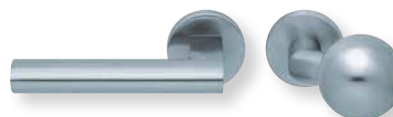

PZ - Wechselgarnitur Knopf gekröpft EDELSTAHL matt

Form 1011 auf Rundrosette

Edelstahl matt

Rosettengarnitur

| | | € exkl. MwSt. |
|---------------------------------------|-----------------|---------------|
| BB - Garnitur | PB3.0-10110 | 45,90 |
| PZ - Garnitur | PB3.0-10112 | 45,90 |
| OS - Garnitur (ohne Schlüsselrosette) | PB3.0-10110S | 41,90 |
| RZ - Garnitur | PB3.0-10118 | 45,90 |
| WC - Garnitur | PB3.0-10113 | 55,90 |
| WC - Garnitur rot/weiß Anz. | PB3.0-101131 | 59,90 |
| WC - Garnitur rot/grün Anz. | PB3.0-101132 | 59,90 |
| PZ-WG - Knopf ger. DIN R/L | PB3.0-10115/6 | 59,90 |
| PZ-WG - Knopf gekr. DIN R/L | PB3.0-101151/61 | 63,90 |

Drückerpaar

| | | |
|---------------|--------|-------|
| ohne Rosetten | D10110 | 25,90 |
|---------------|--------|-------|

Standard-Türstärken: 38 - 42 mm
Aufpreis für Türstärken ab 42 mm: € 5,00

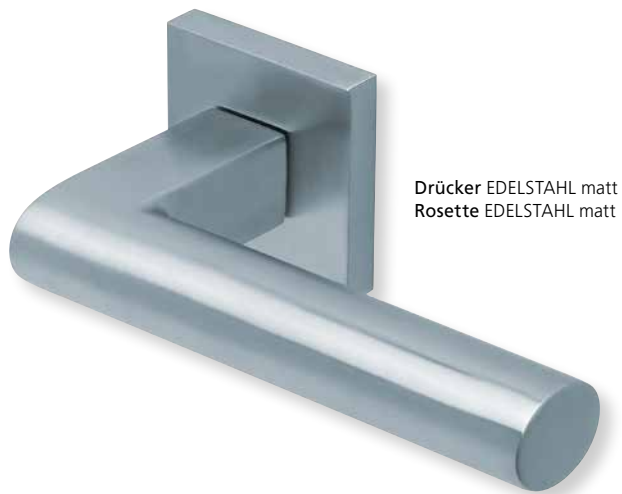

Drücker EDELSTAHL matt
Rosette EDELSTAHL matt

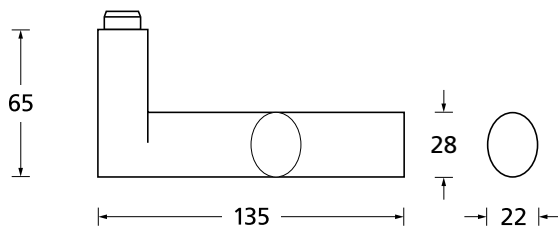



Pullbloc® 3.0 Kugellagertechnik



BB - Garnitur EDELSTAHL matt



PZ - Garnitur EDELSTAHL matt



WC - Garnitur EDELSTAHL matt
WC - Garnitur rot/weiß Anzeige EDELSTAHL matt
WC - Garnitur rot/grün Anzeige EDELSTAHL matt

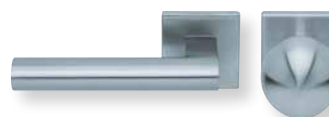

PZ - Wechselgarnitur Knopf gerade
EDELSTAHL matt



RZ - Garnitur EDELSTAHL matt



PZ - Wechselgarnitur Knopf gekröpft
EDELSTAHL matt

Form 1011 auf Quadratrosette

Edelstahl matt

Rosettengarnitur

| | | € exkl. MwSt. |
|---------------------------------------|------------------|---------------|
| BB - Garnitur | PB3.0-Q10110 | 51,90 |
| PZ - Garnitur | PB3.0-Q10112 | 51,90 |
| OS - Garnitur (ohne Schlüsselrosette) | PB3.0-Q10110S | 47,90 |
| RZ - Garnitur | PB3.0-Q10118 | 51,90 |
| WC - Garnitur | PB3.0-Q10113 | 61,90 |
| WC - Garnitur rot/weiß Anz. | PB3.0-Q101131 | 65,90 |
| WC - Garnitur rot/grün Anz. | PB3.0-Q101132 | 65,90 |
| PZ-WG - Knopf ger. DIN R/L | PB3.0-Q10115/6 | 65,90 |
| PZ-WG - Knopf gekr. DIN R/L | PB3.0-Q101151/61 | 69,90 |

Drückerpaar

| | | |
|---------------|--------|-------|
| ohne Rosetten | D10110 | 25,90 |
|---------------|--------|-------|

Standard-Türstärken: 38 - 42 mm
Aufpreis für Türstärken ab 42 mm: € 5,00

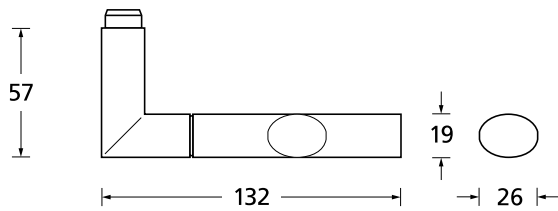



Pullbloc® 3.0 Kugellagertechnik



BB - Garnitur EDELSTAHL matt



PZ - Garnitur EDELSTAHL matt



WC - Garnitur EDELSTAHL matt
 WC - Garnitur rot/weiß Anzeige EDELSTAHL matt
 WC - Garnitur rot/grün Anzeige EDELSTAHL matt



PZ - Wechselgarnitur Knopf gerade
 EDELSTAHL matt



RZ - Garnitur EDELSTAHL matt



PZ - Wechselgarnitur Knopf gekröpft
 EDELSTAHL matt

Form 1012 auf Rundrosette

Edelstahl matt

Rosettengarnitur

| | | € exkl. MwSt. |
|---------------------------------------|-----------------|---------------|
| BB - Garnitur | PB3.0-10120 | 45,90 |
| PZ - Garnitur | PB3.0-10122 | 45,90 |
| OS - Garnitur (ohne Schlüsselrosette) | PB3.0-10120S | 41,90 |
| RZ - Garnitur | PB3.0-10128 | 45,90 |
| WC - Garnitur | PB3.0-10123 | 55,90 |
| WC - Garnitur rot/weiß Anz. | PB3.0-101231 | 59,90 |
| WC - Garnitur rot/grün Anz. | PB3.0-101232 | 59,90 |
| PZ-WG - Knopf ger. DIN R/L | PB3.0-10125/6 | 59,90 |
| PZ-WG - Knopf gekr. DIN R/L | PB3.0-101251/61 | 63,90 |

Drückerpaar

| | | |
|---------------|--------|-------|
| ohne Rosetten | D10120 | 25,90 |
|---------------|--------|-------|

Standard-Türstärken: 38 - 42 mm
 Aufpreis für Türstärken ab 42 mm: € 5,00

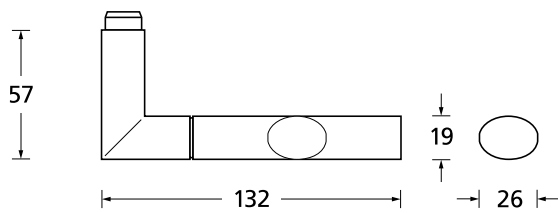



Pullbloc® 3.0 Kugellagertechnik



BB - Garnitur EDELSTAHL matt



PZ - Garnitur EDELSTAHL matt



WC - Garnitur EDELSTAHL matt
WC - Garnitur rot/weiß Anzeige EDELSTAHL matt
WC - Garnitur rot/grün Anzeige EDELSTAHL matt



PZ - Wechselgarnitur Knopf gerade EDELSTAHL matt



RZ - Garnitur EDELSTAHL matt



PZ - Wechselgarnitur Knopf gekröpft EDELSTAHL matt

Form 1012 auf Quadratrosette

Edelstahl matt

Rosettengarnitur

| | | € exkl. MwSt. |
|---------------------------------------|------------------|---------------|
| BB - Garnitur | PB3.0-Q10120 | 51,90 |
| PZ - Garnitur | PB3.0-Q10122 | 51,90 |
| OS - Garnitur (ohne Schlüsselrosette) | PB3.0-Q10120S | 47,90 |
| RZ - Garnitur | PB3.0-Q10128 | 51,90 |
| WC - Garnitur | PB3.0-Q10123 | 61,90 |
| WC - Garnitur rot/weiß Anz. | PB3.0-Q101231 | 65,90 |
| WC - Garnitur rot/grün Anz. | PB3.0-Q101232 | 65,90 |
| PZ-WG - Knopf ger. DIN R/L | PB3.0-Q10125/6 | 65,90 |
| PZ-WG - Knopf gekr. DIN R/L | PB3.0-Q101251/61 | 69,90 |

Drückerpaar

| | | |
|---------------|--------|-------|
| ohne Rosetten | D10120 | 25,90 |
|---------------|--------|-------|

Standard-Türstärken: 38 - 42 mm
Aufpreis für Türstärken ab 42 mm: € 5,00



Drücker EDELSTAHL poliert/EDELSTAHL matt
Rosette EDELSTAHL matt



Drücker EDELSTAHL poliert/EDELSTAHL matt
Rosette EDELSTAHL poliert

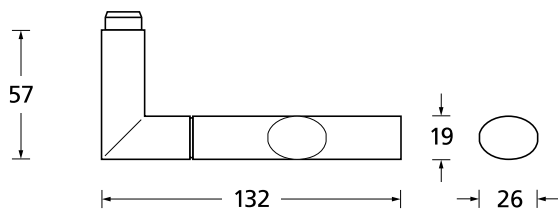



Pullbloc® 3.0 Kugellagertechnik



BB - Garnitur EDELSTAHL poliert



PZ - Garnitur EDELSTAHL poliert



WC - Garnitur EDELSTAHL poliert
WC - Garnitur rot/weiß Anzeige EDELSTAHL poliert
WC - Garnitur rot/grün Anzeige EDELSTAHL poliert



PZ - Wechselgarnitur Knopf gerade EDELSTAHL poliert



RZ - Garnitur EDELSTAHL poliert



PZ - Wechselgarnitur Knopf gekröpft EDELSTAHL poliert

Form 1212 auf Rundrosette

| | Edelstahl matt | | Edelstahl poliert | |
|---------------------------------------|-----------------|-------|-------------------|-------|
| | € exkl. MwSt. | | € exkl. MwSt. | |
| Rosettengarnitur | | | | |
| BB - Garnitur | PB3.0-12120 | 51,90 | PB3.0-P12120 | 57,90 |
| PZ - Garnitur | PB3.0-12122 | 51,90 | PB3.0-P12122 | 57,90 |
| OS - Garnitur (ohne Schlüsselrosette) | PB3.0-12120S | 47,90 | PB3.0-P12120S | 53,90 |
| RZ - Garnitur | PB3.0-12128 | 51,90 | PB3.0-P12128 | 57,90 |
| WC - Garnitur | PB3.0-12123 | 61,90 | PB3.0-P12123 | 67,90 |
| WC - Garnitur rot/weiß Anz. | PB3.0-121231 | 65,90 | PB3.0-P121231 | 71,90 |
| WC - Garnitur rot/grün Anz. | PB3.0-121232 | 65,90 | PB3.0-P121232 | 71,90 |
| PZ-WG - Knopf ger. DIN R/L | PB3.0-12125/6 | 65,90 | PB3.0-P12125/6 | 71,90 |
| PZ-WG - Knopf gekr. DIN R/L | PB3.0-121251/61 | 69,90 | PB3.0-P121251/61 | 75,90 |
| Drückerpaar | | | | |
| ohne Rosetten | D12120 | 29,90 | D12120 | 29,90 |

Standard-Türstärken: 38 - 42 mm
Aufpreis für Türstärken ab 42 mm: € 5,00

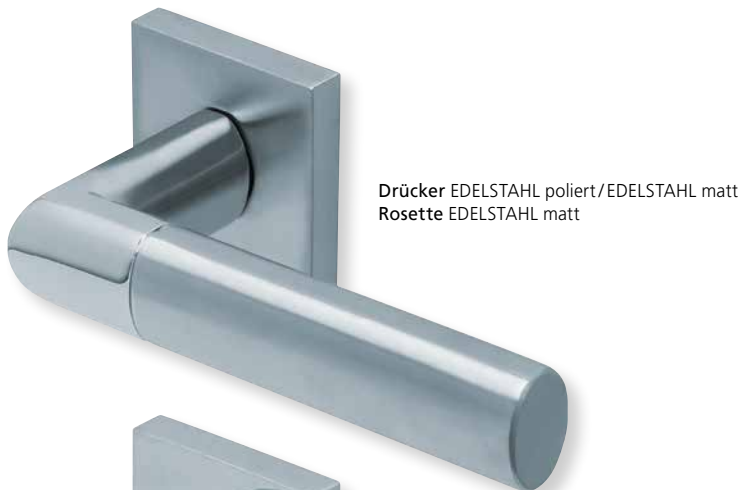

Drücker EDELSTAHL poliert/EDELSTAHL matt
Rosette EDELSTAHL matt



Drücker EDELSTAHL poliert/EDELSTAHL matt
Rosette EDELSTAHL poliert

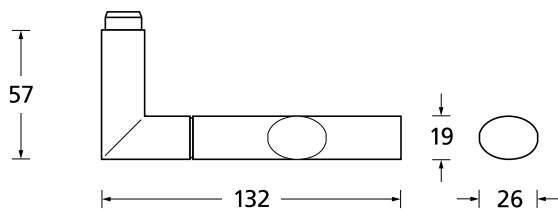



Pullbloc® 3.0 Kugellagertechnik



BB - Garnitur EDELSTAHL poliert



PZ - Garnitur EDELSTAHL poliert



WC - Garnitur EDELSTAHL poliert
WC - Garnitur rot/weiß Anzeige EDELSTAHL poliert
WC - Garnitur rot/grün Anzeige EDELSTAHL poliert



PZ - Wechselgarnitur Knopf gerade EDELSTAHL poliert



RZ - Garnitur EDELSTAHL poliert



PZ - Wechselgarnitur Knopf gekröpft EDELSTAHL poliert

Form 1212 auf Quadratrosette

| | Edelstahl matt | | Edelstahl poliert | |
|---------------------------------------|------------------|---------------|-------------------|---------------|
| | | € exkl. MwSt. | | € exkl. MwSt. |
| Rosettengarnitur | | | | |
| BB - Garnitur | PB3.0-Q12120 | 57,90 | PB3.0-QP12120 | 63,90 |
| PZ - Garnitur | PB3.0-Q12122 | 57,90 | PB3.0-QP12122 | 63,90 |
| OS - Garnitur (ohne Schlüsselrosette) | PB3.0-Q12120S | 53,90 | PB3.0-QP12120S | 59,90 |
| RZ - Garnitur | PB3.0-Q12128 | 57,90 | PB3.0-QP12128 | 63,90 |
| WC - Garnitur | PB3.0-Q12123 | 67,90 | PB3.0-QP12123 | 73,90 |
| WC - Garnitur rot/weiß Anz. | PB3.0-Q121231 | 71,90 | PB3.0-QP121231 | 77,90 |
| WC - Garnitur rot/grün Anz. | PB3.0-Q121232 | 71,90 | PB3.0-QP121232 | 77,90 |
| PZ-WG - Knopf ger. DIN R/L | PB3.0-Q12125/6 | 71,90 | PB3.0-QP12125/6 | 77,90 |
| PZ-WG - Knopf gekr. DIN R/L | PB3.0-Q121251/61 | 75,90 | PB3.0-QP121251/61 | 81,90 |
| Drückerpaar | | | | |
| ohne Rosetten | D12120 | 29,90 | D12120 | 29,90 |

Standard-Türstärken: 38 - 42 mm
Aufpreis für Türstärken ab 42 mm: € 5,00



Drücker EDELSTAHL poliert/EDELSTAHL matt
Rosette EDELSTAHL matt



Drücker EDELSTAHL poliert/EDELSTAHL matt
Rosette EDELSTAHL poliert

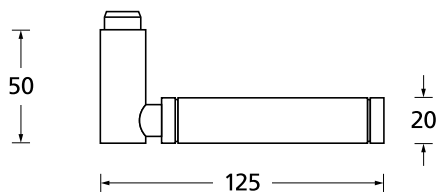



Pullbloc® 3.0 Kugellagertechnik



BB - Garnitur EDELSTAHL poliert



PZ - Garnitur EDELSTAHL poliert



WC - Garnitur EDELSTAHL poliert
WC - Garnitur rot/weiß Anzeige EDELSTAHL poliert
WC - Garnitur rot/grün Anzeige EDELSTAHL poliert



PZ - Wechselgarnitur Knopf gerade EDELSTAHL poliert



RZ - Garnitur EDELSTAHL poliert



PZ - Wechselgarnitur Knopf gekröpft EDELSTAHL poliert

Form 1013 auf Rundrosette

| | Edelstahl matt | | Edelstahl poliert | |
|---------------------------------------|-----------------|-------|-------------------|-------|
| | € exkl. MwSt. | | € exkl. MwSt. | |
| Rosettengarnitur | | | | |
| BB - Garnitur | PB3.0-10130 | 51,90 | PB3.0-P10130 | 57,90 |
| PZ - Garnitur | PB3.0-10132 | 51,90 | PB3.0-P10132 | 57,90 |
| OS - Garnitur (ohne Schlüsselrosette) | PB3.0-10130S | 47,90 | PB3.0-P10130S | 53,90 |
| RZ - Garnitur | PB3.0-10138 | 51,90 | PB3.0-P10138 | 57,90 |
| WC - Garnitur | PB3.0-10133 | 61,90 | PB3.0-P10133 | 67,90 |
| WC - Garnitur rot/weiß Anz. | PB3.0-101331 | 65,90 | PB3.0-P101331 | 71,90 |
| WC - Garnitur rot/grün Anz. | PB3.0-101332 | 65,90 | PB3.0-P101332 | 71,90 |
| PZ-WG - Knopf ger. DIN R/L | PB3.0-10135/6 | 65,90 | PB3.0-P10135/6 | 71,90 |
| PZ-WG - Knopf gekr. DIN R/L | PB3.0-101351/61 | 69,90 | PB3.0-P101351/61 | 75,90 |
| Drückerpaar | | | | |
| ohne Rosetten | D10130 | 29,90 | D10130 | 29,90 |

Standard-Türstärken: 38 - 42 mm
Aufpreis für Türstärken ab 42 mm: € 5,00

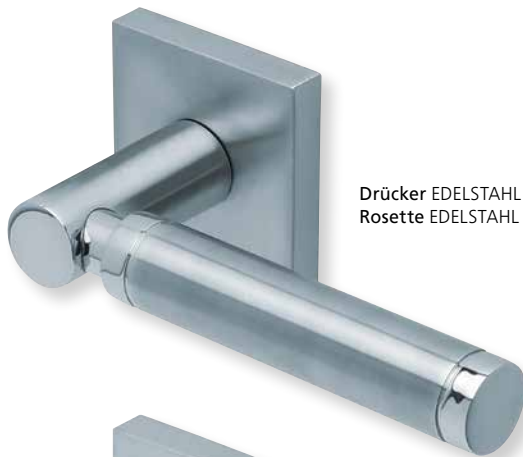

Drücker EDELSTAHL poliert/EDELSTAHL matt
Rosette EDELSTAHL matt

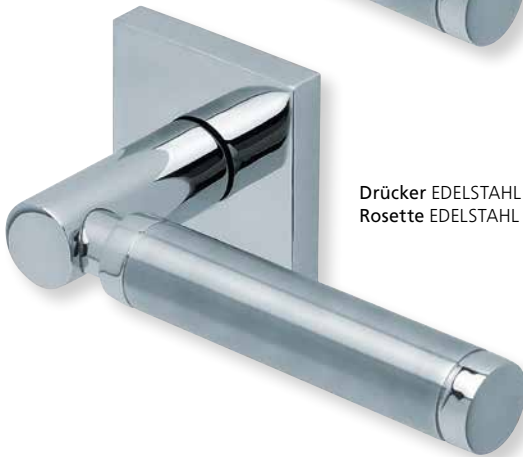

Drücker EDELSTAHL poliert/EDELSTAHL matt
Rosette EDELSTAHL poliert

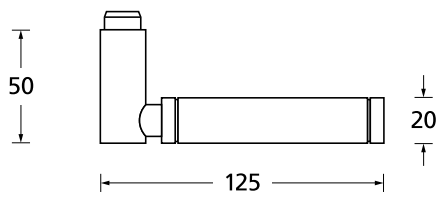



Pullbloc® 3.0 Kugellagertechnik



BB - Garnitur EDELSTAHL poliert



PZ - Garnitur EDELSTAHL poliert



WC - Garnitur EDELSTAHL poliert
WC - Garnitur rot/weiß Anzeige EDELSTAHL poliert
WC - Garnitur rot/grün Anzeige EDELSTAHL poliert



PZ - Wechselgarnitur Knopf gerade EDELSTAHL poliert



RZ - Garnitur EDELSTAHL poliert



PZ - Wechselgarnitur Knopf gekröpft EDELSTAHL poliert

Form 1013 auf Quadratrossette

| | Edelstahl matt | | Edelstahl poliert | |
|----------------------------------------|------------------|---------------|-------------------|---------------|
| | | € exkl. MwSt. | | € exkl. MwSt. |
| Rosettengarnitur | | | | |
| BB - Garnitur | PB3.0-Q10130 | 57,90 | PB3.0-QP10130 | 63,90 |
| PZ - Garnitur | PB3.0-Q10132 | 57,90 | PB3.0-QP10132 | 63,90 |
| OS - Garnitur (ohne Schlüsselrossette) | PB3.0-Q10130S | 53,90 | PB3.0-QP10130S | 59,90 |
| RZ - Garnitur | PB3.0-Q10138 | 57,90 | PB3.0-QP10138 | 63,90 |
| WC - Garnitur | PB3.0-Q10133 | 67,90 | PB3.0-QP10133 | 73,90 |
| WC - Garnitur rot/weiß Anz. | PB3.0-Q101331 | 71,90 | PB3.0-QP101331 | 77,90 |
| WC - Garnitur rot/grün Anz. | PB3.0-Q101332 | 71,90 | PB3.0-QP101332 | 77,90 |
| PZ-WG - Knopf ger. DIN R/L | PB3.0-Q10135/6 | 71,90 | PB3.0-QP10135/6 | 77,90 |
| PZ-WG - Knopf gekr. DIN R/L | PB3.0-Q101351/61 | 75,90 | PB3.0-QP101351/61 | 81,90 |
| Drückerpaar | | | | |
| ohne Rosetten | D10130 | 29,90 | D10130 | 29,90 |

Standard-Türstärken: 38 - 42 mm
Aufpreis für Türstärken ab 42 mm: € 5,00



Drücker EDELSTAHL matt
Rosette EDELSTAHL matt



Drücker EDELSTAHL poliert
Rosette EDELSTAHL poliert



Drücker PVD Messinggelb
Rosette PVD Messinggelb

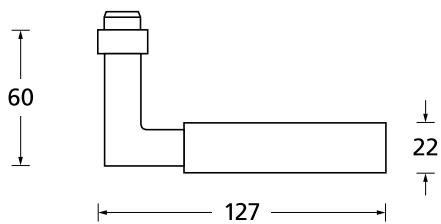



Pullbloc® 3.0 Kugellagertechnik



BB - Garnitur EDELSTAHL matt



PZ - Garnitur EDELSTAHL matt



WC - Garnitur EDELSTAHL matt
WC - Garnitur rot/weiß Anzeige EDELSTAHL matt
WC - Garnitur rot/grün Anzeige EDELSTAHL matt



PZ - Wechselgarnitur Knopf gerade EDELSTAHL matt



RZ - Garnitur EDELSTAHL matt

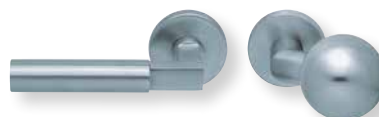

PZ - Wechselgarnitur Knopf gekröpft EDELSTAHL matt

Form 1016 auf Rundrosette

| | Edelstahl matt | | Edelstahl poliert | | PVD Messinggelb | |
|---------------------------------------|-----------------|-------|-------------------|-------|--------------------|-------|
| | € exkl. MwSt. | | € exkl. MwSt. | | € exkl. MwSt. | |
| Rosettengarnitur | | | | | | |
| BB - Garnitur | PB3.0-10160 | 57,90 | PB3.0-P10160 | 67,90 | PB3.0-PVM10160 | 77,90 |
| PZ - Garnitur | PB3.0-10162 | 57,90 | PB3.0-P10162 | 67,90 | PB3.0-PVM10162 | 77,90 |
| OS - Garnitur (ohne Schlüsselrosette) | PB3.0-10160S | 53,90 | PB3.0-P10160S | 63,90 | PB3.0-PVM10160S | 73,90 |
| RZ - Garnitur | PB3.0-10168 | 57,90 | PB3.0-P10168 | 67,90 | PB3.0-PVM10168 | 77,90 |
| WC - Garnitur | PB3.0-10163 | 67,90 | PB3.0-P10163 | 77,90 | PB3.0-PVM10163 | 87,90 |
| WC - Garnitur rot/weiß Anz. | PB3.0-101631 | 71,90 | PB3.0-P101631 | 81,90 | PB3.0-PVM101631 | 91,90 |
| WC - Garnitur rot/grün Anz. | PB3.0-101632 | 71,90 | PB3.0-P101632 | 81,90 | PB3.0-PVM101632 | 91,90 |
| PZ-WG - Knopf ger. DIN R/L | PB3.0-10165/6 | 71,90 | PB3.0-P10165/6 | 81,90 | PB3.0-PVM10165/6 | 91,90 |
| PZ-WG - Knopf gekr. DIN R/L | PB3.0-101651/61 | 75,90 | PB3.0-P101651/61 | 85,90 | PB3.0-PVM101651/61 | 95,90 |
| Drückerpaar | | | | | | |
| ohne Rosetten | D101601 | 33,90 | DP101601 | 41,90 | DPVM101601 | 49,90 |

Standard-Türstärken: 38 - 42 mm
Aufpreis für Türstärken ab 42 mm: € 5,00



Drücker EDELSTAHL matt
Rosette EDELSTAHL matt



Drücker EDELSTAHL poliert
Rosette EDELSTAHL poliert

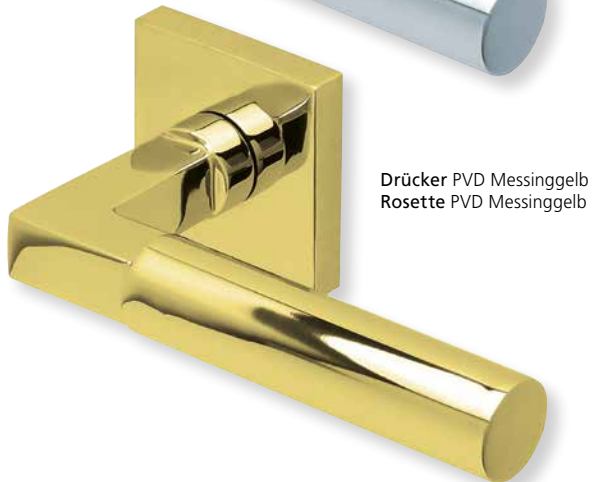

Drücker PVD Messinggelb
Rosette PVD Messinggelb

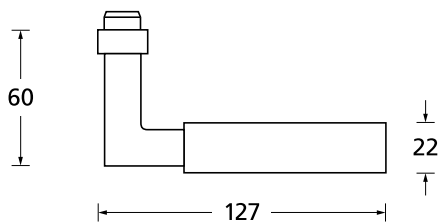



Pullbloc® 3.0 Kugellagertechnik



BB - Garnitur EDELSTAHL poliert



PZ - Garnitur EDELSTAHL poliert



WC - Garnitur EDELSTAHL poliert
WC - Garnitur rot/weiß Anzeige EDELSTAHL poliert
WC - Garnitur rot/grün Anzeige EDELSTAHL poliert



PZ - Wechselgarnitur Knopf gerade EDELSTAHL poliert



RZ - Garnitur EDELSTAHL poliert



PZ - Wechselgarnitur Knopf gekröpft EDELSTAHL poliert

Form 1016 auf Quadratrosette

| | Edelstahl matt | | Edelstahl poliert | | PVD Messinggelb | |
|---------------------------------------|------------------|-------|-------------------|-------|---------------------|--------|
| | € exkl. MwSt. | | € exkl. MwSt. | | € exkl. MwSt. | |
| Rosettengarnitur | | | | | | |
| BB - Garnitur | PB3.0-Q10160 | 63,90 | PB3.0-QP10160 | 73,90 | PB3.0-QPVM10160 | 83,90 |
| PZ - Garnitur | PB3.0-Q10162 | 63,90 | PB3.0-QP10162 | 73,90 | PB3.0-QPVM10162 | 83,90 |
| OS - Garnitur (ohne Schlüsselrosette) | PB3.0-Q10160S | 59,90 | PB3.0-QP10160S | 69,90 | PB3.0-QPVM10160S | 79,90 |
| RZ - Garnitur | PB3.0-Q10168 | 63,90 | PB3.0-QP10168 | 73,90 | PB3.0-QPVM10168 | 83,90 |
| WC - Garnitur | PB3.0-Q10163 | 73,90 | PB3.0-QP10163 | 83,90 | PB3.0-QPVM10163 | 93,90 |
| WC - Garnitur rot/weiß Anz. | PB3.0-Q101631 | 77,90 | PB3.0-QP101631 | 87,90 | PB3.0-QPVM101631 | 97,90 |
| WC - Garnitur rot/grün Anz. | PB3.0-Q101632 | 77,90 | PB3.0-QP101632 | 87,90 | PB3.0-QPVM101632 | 97,90 |
| PZ-WG - Knopf ger. DIN R/L | PB3.0-Q10165/6 | 77,90 | PB3.0-QP10165/6 | 87,90 | PB3.0-QPVM10165/6 | 97,90 |
| PZ-WG - Knopf gekr. DIN R/L | PB3.0-Q101651/61 | 81,90 | PB3.0-QP101651/61 | 91,90 | PB3.0-QPVM101651/61 | 101,90 |
| Drückerpaar | | | | | | |
| ohne Rosetten | D101601 | 33,90 | DP101601 | 41,90 | DPVM101601 | 49,90 |

Standard-Türstärken: 38 - 42 mm
Aufpreis für Türstärken ab 42 mm: € 5,00



Drücker EDELSTAHL matt
Rosette EDELSTAHL matt



Drücker EDELSTAHL poliert
Rosette EDELSTAHL poliert

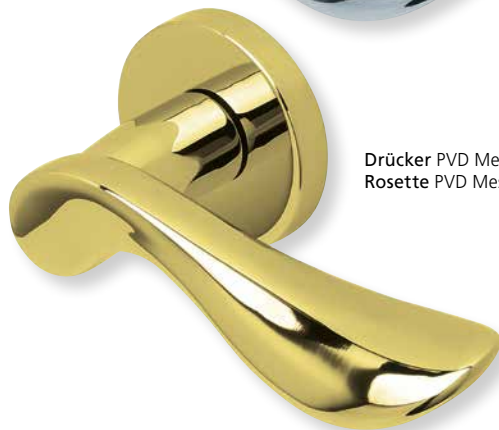

Drücker PVD Messinggelb
Rosette PVD Messinggelb

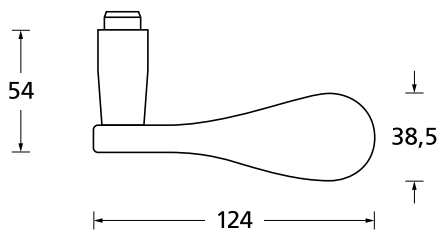



Pullbloc® 3.0 Kugellagertechnik

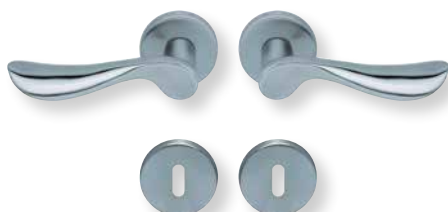

BB - Garnitur EDELSTAHL matt

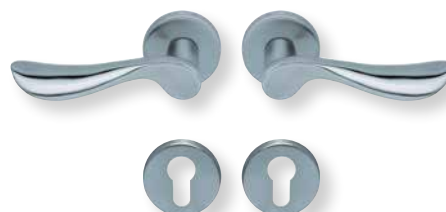

PZ - Garnitur EDELSTAHL matt



WC - Garnitur EDELSTAHL matt
WC - Garnitur rot/weiß Anzeige EDELSTAHL matt
WC - Garnitur rot/grün Anzeige EDELSTAHL matt



PZ - Wechselgarnitur Knopf gerade
EDELSTAHL matt



RZ - Garnitur EDELSTAHL matt

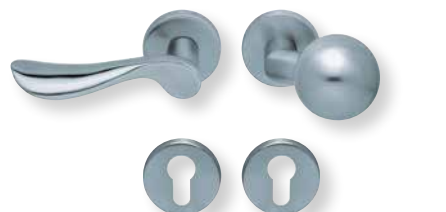

PZ - Wechselgarnitur Knopf gekröpft
EDELSTAHL matt

Form 1018 auf Rundrosette

| | Edelstahl matt | | Edelstahl poliert | | PVD Messinggelb | |
|---------------------------------------|-----------------|-------|-------------------|-------|--------------------|-------|
| | € exkl. MwSt. | | € exkl. MwSt. | | € exkl. MwSt. | |
| Rosettengarnitur | | | | | | |
| BB - Garnitur | PB3.0-10180 | 51,90 | PB3.0-P10180 | 61,90 | PB3.0-PVM10180 | 71,90 |
| PZ - Garnitur | PB3.0-10182 | 51,90 | PB3.0-P10182 | 61,90 | PB3.0-PVM10182 | 71,90 |
| OS - Garnitur (ohne Schlüsselrosette) | PB3.0-10180S | 47,90 | PB3.0-P10180S | 57,90 | PB3.0-PVM10180S | 67,90 |
| RZ - Garnitur | PB3.0-10188 | 51,90 | PB3.0-P10188 | 61,90 | PB3.0-PVM10188 | 71,90 |
| WC - Garnitur | PB3.0-10183 | 61,90 | PB3.0-P10183 | 71,90 | PB3.0-PVM10183 | 81,90 |
| WC - Garnitur rot/weiß Anz. | PB3.0-101831 | 65,90 | PB3.0-P101831 | 75,90 | PB3.0-PVM101831 | 85,90 |
| WC - Garnitur rot/grün Anz. | PB3.0-101832 | 65,90 | PB3.0-P101832 | 75,90 | PB3.0-PVM101832 | 85,90 |
| PZ-WG - Knopf ger. DIN R/L | PB3.0-10185/6 | 65,90 | PB3.0-P10185/6 | 75,90 | PB3.0-PVM10185/6 | 85,90 |
| PZ-WG - Knopf gekr. DIN R/L | PB3.0-101851/61 | 69,90 | PB3.0-P101851/61 | 79,90 | PB3.0-PVM101851/61 | 89,90 |
| Drückerpaar | | | | | | |
| ohne Rosetten | D10180 | 29,90 | DP10180 | 37,90 | DPVM10180 | 45,90 |

Standard-Türstärken: 38 - 42 mm
Aufpreis für Türstärken ab 42 mm: € 5,00



Drücker EDELSTAHL matt
Rosette EDELSTAHL matt



Drücker EDELSTAHL poliert
Rosette EDELSTAHL poliert



Drücker PVD Messinggelb
Rosette PVD Messinggelb

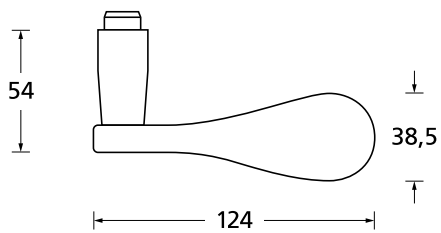



Pullbloc® 3.0 Kugellagertechnik



BB - Garnitur EDELSTAHL poliert



PZ - Garnitur EDELSTAHL poliert



WC - Garnitur EDELSTAHL poliert
WC - Garnitur rot/weiß Anzeige EDELSTAHL poliert
WC - Garnitur rot/grün Anzeige EDELSTAHL poliert



PZ - Wechselgarnitur Knopf gerade EDELSTAHL poliert



RZ - Garnitur EDELSTAHL poliert



PZ - Wechselgarnitur Knopf gekröpft EDELSTAHL poliert

Form 1018 auf Quadratrossette

| | Edelstahl matt | | Edelstahl poliert | | PVD Messinggelb | |
|----------------------------------------|------------------|-------|-------------------|-------|---------------------|-------|
| | € exkl. MwSt. | | € exkl. MwSt. | | € exkl. MwSt. | |
| Rosettengarnitur | | | | | | |
| BB - Garnitur | PB3.0-Q10180 | 57,90 | PB3.0-QP10180 | 67,90 | PB3.0-QPVM10180 | 77,90 |
| PZ - Garnitur | PB3.0-Q10182 | 57,90 | PB3.0-QP10182 | 67,90 | PB3.0-QPVM10182 | 77,90 |
| OS - Garnitur (ohne Schlüsselrossette) | PB3.0-Q10180S | 53,90 | PB3.0-QP10180S | 63,90 | PB3.0-QPVM10180S | 73,90 |
| RZ - Garnitur | PB3.0-Q10188 | 57,90 | PB3.0-QP10188 | 67,90 | PB3.0-QPVM10188 | 77,90 |
| WC - Garnitur | PB3.0-Q10183 | 67,90 | PB3.0-QP10183 | 77,90 | PB3.0-QPVM10183 | 87,90 |
| WC - Garnitur rot/weiß Anz. | PB3.0-Q101831 | 71,90 | PB3.0-QP101831 | 81,90 | PB3.0-QPVM101831 | 91,90 |
| WC - Garnitur rot/grün Anz. | PB3.0-Q101832 | 71,90 | PB3.0-QP101832 | 81,90 | PB3.0-QPVM101832 | 91,90 |
| PZ-WG - Knopf ger. DIN R/L | PB3.0-Q10185/6 | 71,90 | PB3.0-QP10185/6 | 81,90 | PB3.0-QPVM10185/6 | 91,90 |
| PZ-WG - Knopf gekr. DIN R/L | PB3.0-Q101851/61 | 75,90 | PB3.0-QP101851/61 | 85,90 | PB3.0-QPVM101851/61 | 95,90 |
| Drückerpaar | | | | | | |
| ohne Rosetten | D10180 | 29,90 | DP10180 | 37,90 | DPVM10180 | 45,90 |

Standard-Türstärken: 38 - 42 mm
Aufpreis für Türstärken ab 42 mm: € 5,00

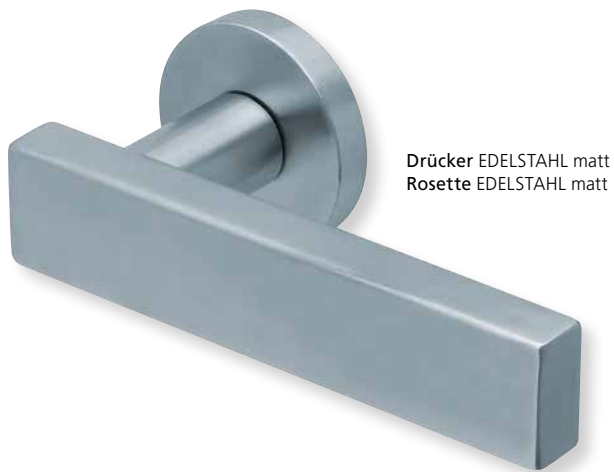

Drücker EDELSTAHL matt
Rosette EDELSTAHL matt

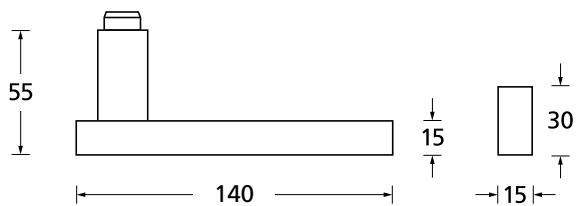



Pullbloc® 3.0 Kugellagertechnik



BB - Garnitur EDELSTAHL matt



PZ - Garnitur EDELSTAHL matt



WC - Garnitur EDELSTAHL matt
WC - Garnitur rot/weiß Anzeige EDELSTAHL matt
WC - Garnitur rot/grün Anzeige EDELSTAHL matt



PZ - Wechselgarnitur Knopf gerade
EDELSTAHL matt



RZ - Garnitur EDELSTAHL matt



PZ - Wechselgarnitur Knopf gekröpft
EDELSTAHL matt

Form 1019 auf Rundrosette

Edelstahl matt

Rosettengarnitur

| | | € exkl. MwSt. |
|---------------------------------------|-----------------|---------------|
| BB - Garnitur | PB3.0-10190 | 45,90 |
| PZ - Garnitur | PB3.0-10192 | 45,90 |
| OS - Garnitur (ohne Schlüsselrosette) | PB3.0-10190S | 41,90 |
| RZ - Garnitur | PB3.0-10198 | 45,90 |
| WC - Garnitur | PB3.0-10193 | 55,90 |
| WC - Garnitur rot/weiß Anz. | PB3.0-101931 | 59,90 |
| WC - Garnitur rot/grün Anz. | PB3.0-101932 | 59,90 |
| PZ-WG - Knopf ger. DIN R/L | PB3.0-10195/6 | 59,90 |
| PZ-WG - Knopf gekr. DIN R/L | PB3.0-101951/61 | 63,90 |

Drückerpaar

| | | |
|---------------|--------|-------|
| ohne Rosetten | D10190 | 25,90 |
|---------------|--------|-------|

Standard-Türstärken: 38 - 42 mm
Aufpreis für Türstärken ab 42 mm: € 5,00

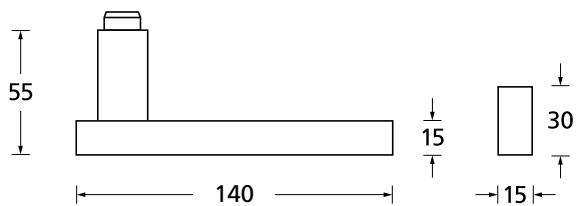
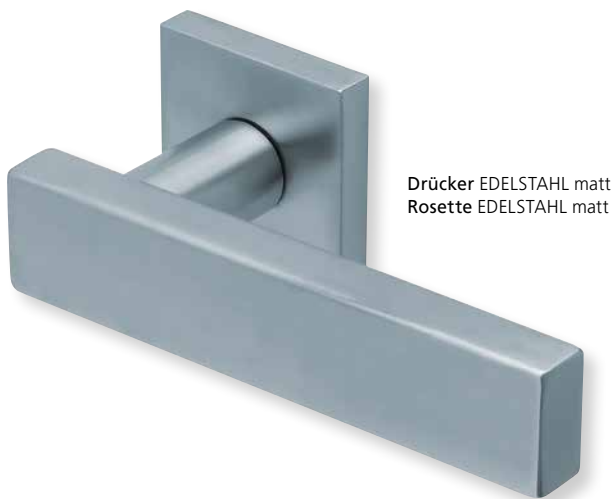



Pullbloc® 3.0 Kugellagertechnik



BB - Garnitur EDELSTAHL matt



PZ - Garnitur EDELSTAHL matt



WC - Garnitur EDELSTAHL matt
WC - Garnitur rot/weiß Anzeige EDELSTAHL matt
WC - Garnitur rot/grün Anzeige EDELSTAHL matt



PZ - Wechselgarnitur Knopf gerade EDELSTAHL matt



RZ - Garnitur EDELSTAHL matt



PZ - Wechselgarnitur Knopf gekröpft EDELSTAHL matt

Form 1019 auf Quadratrosette

Edelstahl matt

Rosettengarnitur

| | | € exkl. MwSt. |
|---------------------------------------|------------------|---------------|
| BB - Garnitur | PB3.0-Q10190 | 51,90 |
| PZ - Garnitur | PB3.0-Q10192 | 51,90 |
| OS - Garnitur (ohne Schlüsselrosette) | PB3.0-Q10190S | 47,90 |
| RZ - Garnitur | PB3.0-Q10198 | 51,90 |
| WC - Garnitur | PB3.0-Q10193 | 61,90 |
| WC - Garnitur rot/weiß Anz. | PB3.0-Q101931 | 65,90 |
| WC - Garnitur rot/grün Anz. | PB3.0-Q101932 | 65,90 |
| PZ-WG - Knopf ger. DIN R/L | PB3.0-Q10195/6 | 65,90 |
| PZ-WG - Knopf gekr. DIN R/L | PB3.0-Q101951/61 | 69,90 |

Drückerpaar

| | | |
|---------------|--------|-------|
| ohne Rosetten | D10190 | 25,90 |
|---------------|--------|-------|

Standard-Türstärken: 38 - 42 mm
Aufpreis für Türstärken ab 42 mm: € 5,00



Drücker EDELSTAHL matt
Rosette EDELSTAHL matt



Drücker EDELSTAHL poliert
Rosette EDELSTAHL poliert



Drücker PVD Messinggelb
Rosette PVD Messinggelb

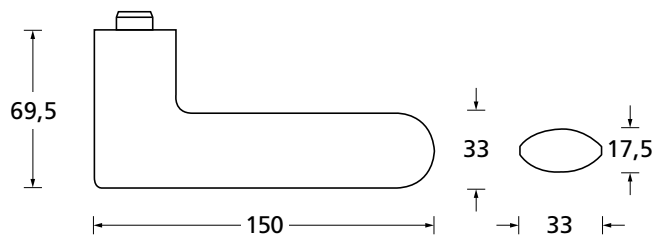



Pullbloc® 3.0 Kugellagertechnik

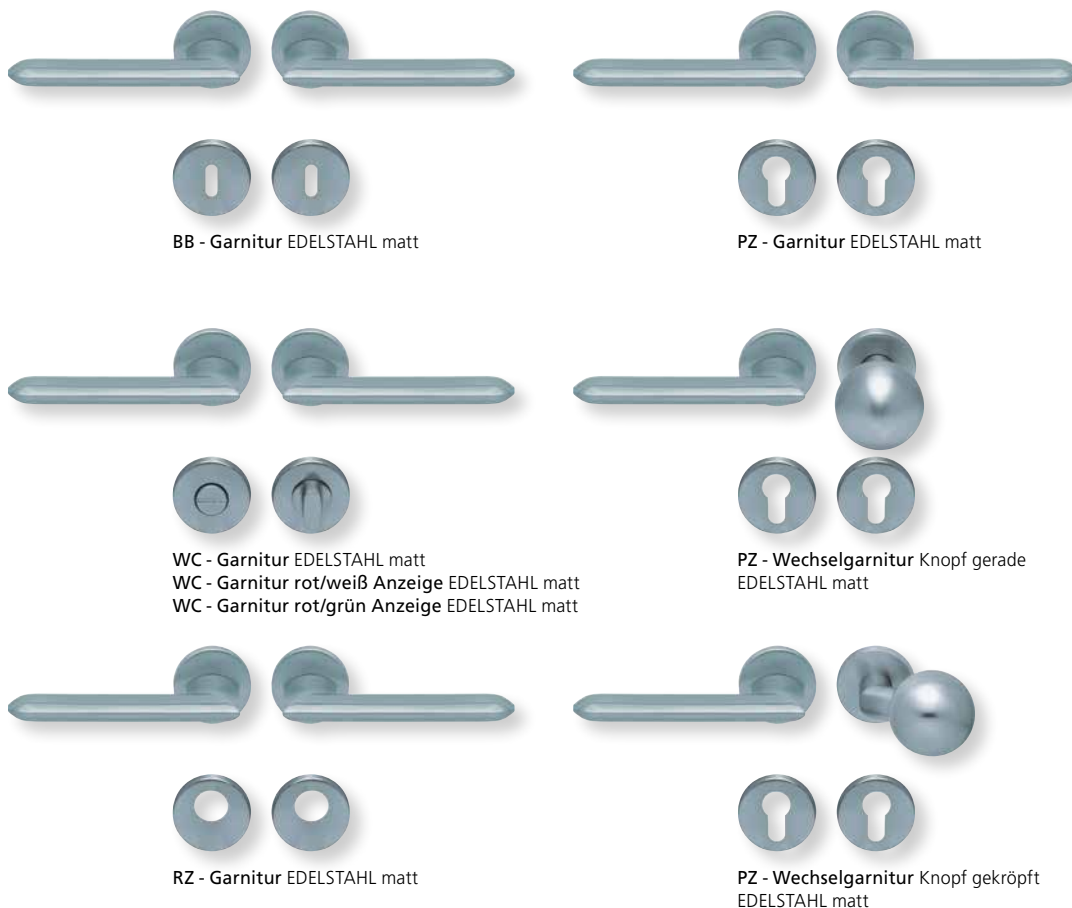

Form 1021 auf Rundrosette

| | Edelstahl matt | | Edelstahl poliert | | PVD Messinggelb | |
|---------------------------------------|-----------------|-------|-------------------|-------|--------------------|-------|
| | € exkl. MwSt. | | € exkl. MwSt. | | € exkl. MwSt. | |
| Rosettengarnitur | | | | | | |
| BB - Garnitur | PB3.0-10210 | 57,90 | PB3.0-P10210 | 67,90 | PB3.0-PVM10210 | 77,90 |
| PZ - Garnitur | PB3.0-10212 | 57,90 | PB3.0-P10212 | 67,90 | PB3.0-PVM10212 | 77,90 |
| OS - Garnitur (ohne Schlüsselrosette) | PB3.0-10210S | 53,90 | PB3.0-P10210S | 63,90 | PB3.0-PVM10210S | 73,90 |
| RZ - Garnitur | PB3.0-10218 | 57,90 | PB3.0-P10218 | 67,90 | PB3.0-PVM10218 | 77,90 |
| WC - Garnitur | PB3.0-10213 | 67,90 | PB3.0-P10213 | 77,90 | PB3.0-PVM10213 | 87,90 |
| WC - Garnitur rot/weiß Anz. | PB3.0-102131 | 71,90 | PB3.0-P102131 | 81,90 | PB3.0-PVM102131 | 91,90 |
| WC - Garnitur rot/grün Anz. | PB3.0-102132 | 71,90 | PB3.0-P102132 | 81,90 | PB3.0-PVM102132 | 91,90 |
| PZ-WG - Knopf ger. DIN R/L | PB3.0-10215/6 | 71,90 | PB3.0-P10215/6 | 81,90 | PB3.0-PVM10215/6 | 91,90 |
| PZ-WG - Knopf gekr. DIN R/L | PB3.0-102151/61 | 75,90 | PB3.0-P102151/61 | 85,90 | PB3.0-PVM102151/61 | 95,90 |
| Drückerpaar | | | | | | |
| ohne Rosetten | D10210 | 33,90 | DP10210 | 41,90 | DPVM10210 | 49,90 |

Standard-Türstärken: 38 - 42 mm
 Aufpreis für Türstärken ab 42 mm: € 5,00



Drücker EDELSTAHL matt
Rosette EDELSTAHL matt



Drücker EDELSTAHL poliert
Rosette EDELSTAHL poliert



Drücker PVD Messinggelb
Rosette PVD Messinggelb

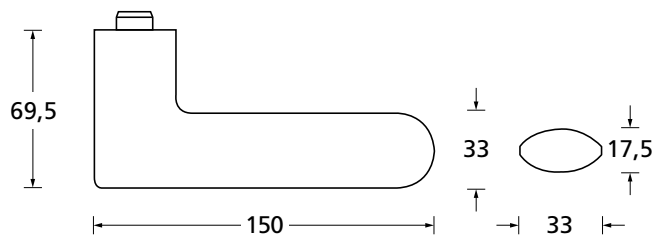



Pullbloc® 3.0 Kugellagertechnik

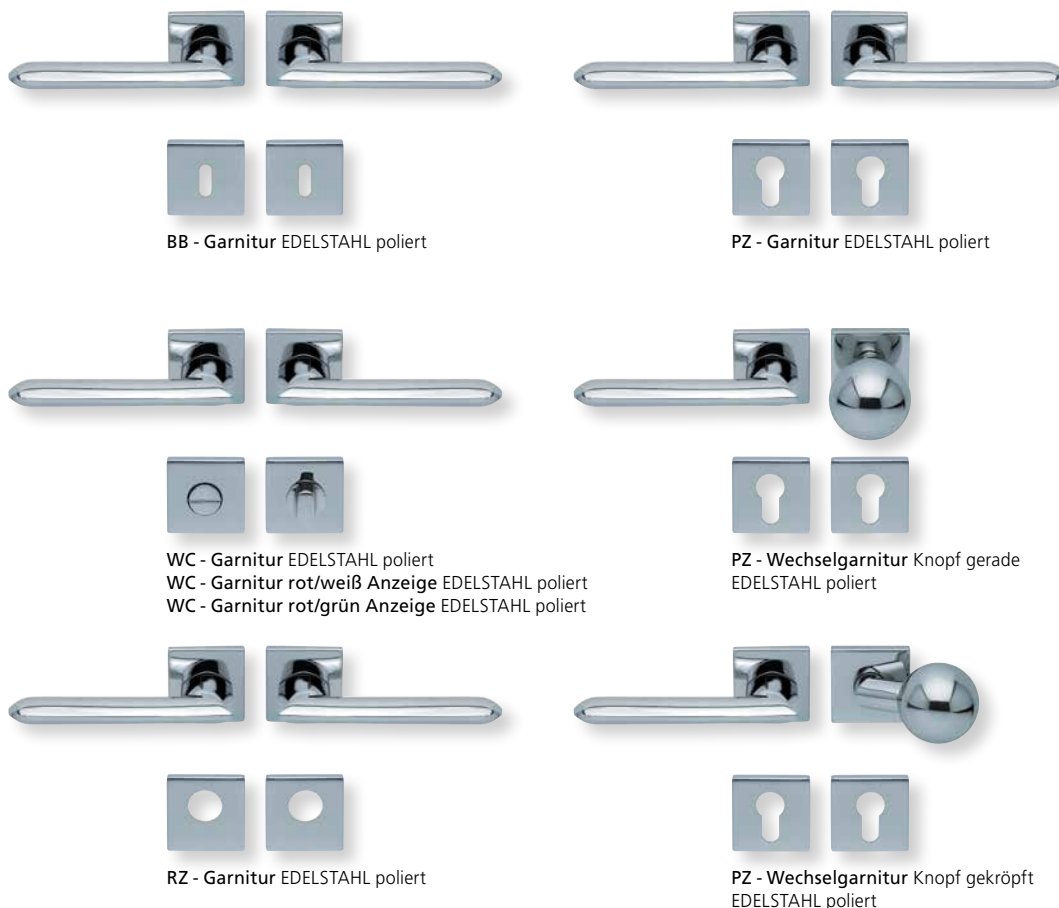

Form 1021 auf Quadratrosette

| | Edelstahl matt | | Edelstahl poliert | | PVD Messinggelb | |
|---------------------------------------|------------------|-------|-------------------|-------|---------------------|--------|
| | € exkl. MwSt. | | € exkl. MwSt. | | € exkl. MwSt. | |
| Rosettengarnitur | | | | | | |
| BB - Garnitur | PB3.0-Q10210 | 63,90 | PB3.0-QP10210 | 73,90 | PB3.0-QPVM10210 | 83,90 |
| PZ - Garnitur | PB3.0-Q10212 | 63,90 | PB3.0-QP10212 | 73,90 | PB3.0-QPVM10212 | 83,90 |
| OS - Garnitur (ohne Schlüsselrosette) | PB3.0-Q10210S | 59,90 | PB3.0-QP10210S | 69,90 | PB3.0-QPVM10210S | 79,90 |
| RZ - Garnitur | PB3.0-Q10218 | 63,90 | PB3.0-QP10218 | 73,90 | PB3.0-QPVM10218 | 83,90 |
| WC - Garnitur | PB3.0-Q10213 | 73,90 | PB3.0-QP10213 | 83,90 | PB3.0-QPVM10213 | 93,90 |
| WC - Garnitur rot/weiß Anz. | PB3.0-Q102131 | 77,90 | PB3.0-QP102131 | 87,90 | PB3.0-QPVM102131 | 97,90 |
| WC - Garnitur rot/grün Anz. | PB3.0-Q102132 | 77,90 | PB3.0-QP102132 | 87,90 | PB3.0-QPVM102132 | 97,90 |
| PZ-WG - Knopf ger. DIN R/L | PB3.0-Q10215/6 | 77,90 | PB3.0-QP10215/6 | 87,90 | PB3.0-QPVM10215/6 | 97,90 |
| PZ-WG - Knopf gekr. DIN R/L | PB3.0-Q102151/61 | 81,90 | PB3.0-QP102151/61 | 91,90 | PB3.0-QPVM102151/61 | 101,90 |
| Drückerpaar | | | | | | |
| ohne Rosetten | D10210 | 33,90 | DP10210 | 41,90 | DPVM10210 | 49,90 |

Standard-Türstärken: 38 - 42 mm
 Aufpreis für Türstärken ab 42 mm: € 5,00



Drücker EDELSTAHL matt
Rosette EDELSTAHL matt



Drücker EDELSTAHL poliert
Rosette EDELSTAHL poliert

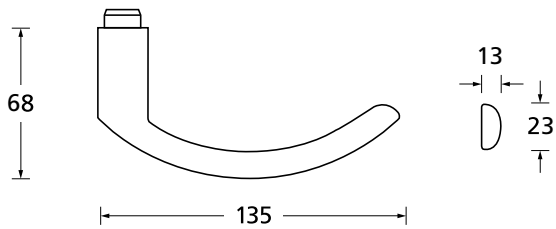



Pullbloc® 3.0 Kugellagertechnik

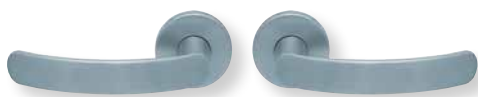

BB - Garnitur EDELSTAHL matt

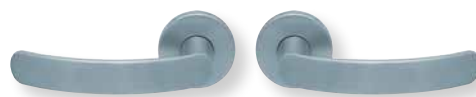

PZ - Garnitur EDELSTAHL matt



WC - Garnitur EDELSTAHL matt
WC - Garnitur rot/weiß Anzeige EDELSTAHL matt
WC - Garnitur rot/grün Anzeige EDELSTAHL matt



PZ - Wechselgarnitur Knopf gerade EDELSTAHL matt



RZ - Garnitur EDELSTAHL matt



PZ - Wechselgarnitur Knopf gekröpft EDELSTAHL matt

Form 1023 auf Rundrosette

| | Edelstahl matt | | Edelstahl poliert | |
|---------------------------------------|-----------------|---------------|-------------------|---------------|
| | | € exkl. MwSt. | | € exkl. MwSt. |
| Rosettengarnitur | | | | |
| BB - Garnitur | PB3.0-10230 | 45,90 | PB3.0-P10230 | 55,90 |
| PZ - Garnitur | PB3.0-10232 | 45,90 | PB3.0-P10232 | 55,90 |
| OS - Garnitur (ohne Schlüsselrosette) | PB3.0-1023OS | 41,90 | PB3.0-P1023OS | 51,90 |
| RZ - Garnitur | PB3.0-10238 | 45,90 | PB3.0-P10238 | 55,90 |
| WC - Garnitur | PB3.0-10233 | 55,90 | PB3.0-P10233 | 65,90 |
| WC - Garnitur rot/weiß Anz. | PB3.0-102331 | 59,90 | PB3.0-P102331 | 69,90 |
| WC - Garnitur rot/grün Anz. | PB3.0-102332 | 59,90 | PB3.0-P102332 | 69,90 |
| PZ-WG - Knopf ger. DIN R/L | PB3.0-10235/6 | 59,90 | PB3.0-P10235/6 | 69,90 |
| PZ-WG - Knopf gekr. DIN R/L | PB3.0-102351/61 | 63,90 | PB3.0-P102351/61 | 73,90 |
| Drückerpaar | | | | |
| ohne Rosetten | D10230 | 25,90 | DP10230 | 33,90 |

Standard-Türstärken: 38 - 42 mm
Aufpreis für Türstärken ab 42 mm: € 5,00



Drücker EDELSTAHL matt
Rosette EDELSTAHL matt



Drücker EDELSTAHL poliert
Rosette EDELSTAHL poliert

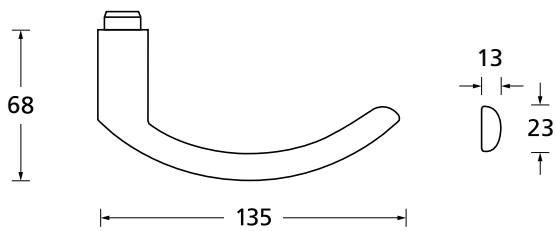



Pullbloc® 3.0 Kugellagertechnik



BB - Garnitur EDELSTAHL poliert



PZ - Garnitur EDELSTAHL poliert



WC - Garnitur EDELSTAHL poliert
WC - Garnitur rot/weiß Anzeige EDELSTAHL poliert
WC - Garnitur rot/grün Anzeige EDELSTAHL poliert



PZ - Wechselgarnitur Knopf gerade EDELSTAHL poliert



RZ - Garnitur EDELSTAHL poliert



PZ - Wechselgarnitur Knopf gekröpft EDELSTAHL poliert

Form 1023 auf Quadratrosette

| | Edelstahl matt | | Edelstahl poliert | |
|---------------------------------------|------------------|---------------|-------------------|---------------|
| | | € exkl. MwSt. | | € exkl. MwSt. |
| Rosettengarnitur | | | | |
| BB - Garnitur | PB3.0-Q10230 | 51,90 | PB3.0-QP10230 | 61,90 |
| PZ - Garnitur | PB3.0-Q10232 | 51,90 | PB3.0-QP10232 | 61,90 |
| OS - Garnitur (ohne Schlüsselrosette) | PB3.0-Q1023OS | 47,90 | PB3.0-QP1023OS | 57,90 |
| RZ - Garnitur | PB3.0-Q10238 | 51,90 | PB3.0-QP10238 | 61,90 |
| WC - Garnitur | PB3.0-Q10233 | 61,90 | PB3.0-QP10233 | 71,90 |
| WC - Garnitur rot/weiß Anz. | PB3.0-Q102331 | 65,90 | PB3.0-QP102331 | 75,90 |
| WC - Garnitur rot/grün Anz. | PB3.0-Q102332 | 65,90 | PB3.0-QP102332 | 75,90 |
| PZ-WG - Knopf ger. DIN R/L | PB3.0-Q10235/6 | 65,90 | PB3.0-QP10235/6 | 75,90 |
| PZ-WG - Knopf gekr. DIN R/L | PB3.0-Q102351/61 | 69,90 | PB3.0-QP102351/61 | 79,90 |
| Drückerpaar | | | | |
| ohne Rosetten | D10230 | 25,90 | DP10230 | 33,90 |

Standard-Türstärken: 38 - 42 mm
Aufpreis für Türstärken ab 42 mm: € 5,00



Drücker EDELSTAHL matt
Rosette EDELSTAHL matt

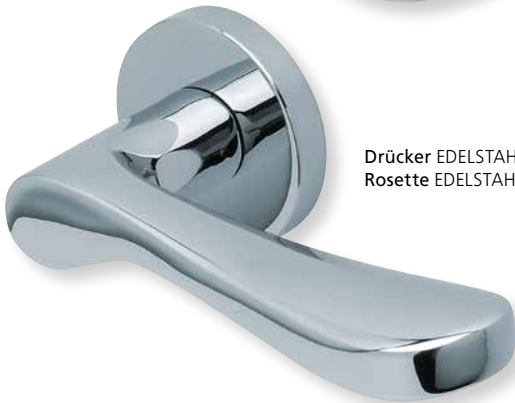

Drücker EDELSTAHL poliert
Rosette EDELSTAHL poliert



Drücker PVD Messinggelb
Rosette PVD Messinggelb

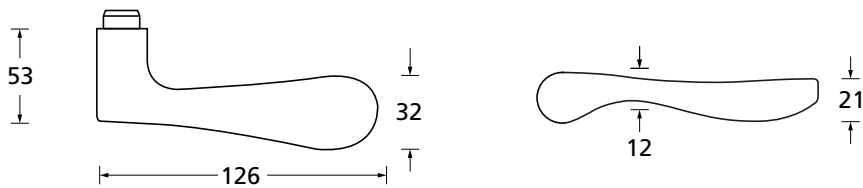



Pullbloc® 3.0 Kugellagertechnik



BB - Garnitur EDELSTAHL matt



PZ - Garnitur EDELSTAHL matt



WC - Garnitur EDELSTAHL matt
WC - Garnitur rot/weiß Anzeige EDELSTAHL matt
WC - Garnitur rot/grün Anzeige EDELSTAHL matt



PZ - Wechselgarnitur Knopf gerade
EDELSTAHL matt



RZ - Garnitur EDELSTAHL matt



PZ - Wechselgarnitur Knopf gekröpft
EDELSTAHL matt

Form 1024 auf Rundrosette

| | Edelstahl matt | | Edelstahl poliert | | PVD Messinggelb | |
|---------------------------------------|-----------------|-------|-------------------|-------|--------------------|-------|
| | € exkl. MwSt. | | € exkl. MwSt. | | € exkl. MwSt. | |
| Rosettengarnitur | | | | | | |
| BB - Garnitur | PB3.0-10240 | 51,90 | PB3.0-P10240 | 61,90 | PB3.0-PVM10240 | 71,90 |
| PZ - Garnitur | PB3.0-10242 | 51,90 | PB3.0-P10242 | 61,90 | PB3.0-PVM10242 | 71,90 |
| OS - Garnitur (ohne Schlüsselrosette) | PB3.0-1024OS | 47,90 | PB3.0-P1024OS | 57,90 | PB3.0-PVM1024OS | 67,90 |
| RZ - Garnitur | PB3.0-10248 | 51,90 | PB3.0-P10248 | 61,90 | PB3.0-PVM10248 | 71,90 |
| WC - Garnitur | PB3.0-10243 | 61,90 | PB3.0-P10243 | 71,90 | PB3.0-PVM10243 | 81,90 |
| WC - Garnitur rot/weiß Anz. | PB3.0-102431 | 65,90 | PB3.0-P102431 | 75,90 | PB3.0-PVM102431 | 85,90 |
| WC - Garnitur rot/grün Anz. | PB3.0-102432 | 65,90 | PB3.0-P102432 | 75,90 | PB3.0-PVM102432 | 85,90 |
| PZ-WG - Knopf ger. DIN R/L | PB3.0-10245/6 | 65,90 | PB3.0-P10245/6 | 75,90 | PB3.0-PVM10245/6 | 85,90 |
| PZ-WG - Knopf gekr. DIN R/L | PB3.0-102451/61 | 69,90 | PB3.0-P102451/61 | 79,90 | PB3.0-PVM102451/61 | 89,90 |
| Drückerpaar | | | | | | |
| ohne Rosetten | D10240 | 29,90 | DP10240 | 37,90 | DPVM10240 | 45,90 |

Standard-Türstärken: 38 - 42 mm
Aufpreis für Türstärken ab 42 mm: € 5,00



Drücker EDELSTAHL matt
Rosette EDELSTAHL matt



Drücker EDELSTAHL poliert
Rosette EDELSTAHL poliert



Drücker PVD Messinggelb
Rosette PVD Messinggelb

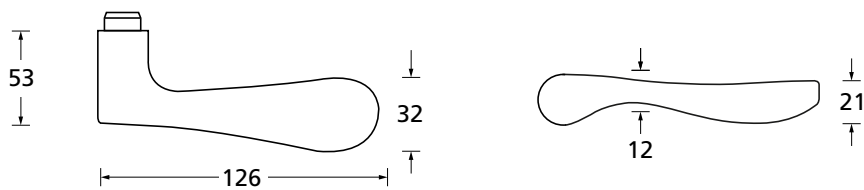



Pullbloc® 3.0 Kugellagertechnik



BB - Garnitur EDELSTAHL poliert



PZ - Garnitur EDELSTAHL poliert



WC - Garnitur EDELSTAHL poliert
WC - Garnitur rot/weiß Anzeige EDELSTAHL poliert
WC - Garnitur rot/grün Anzeige EDELSTAHL poliert



PZ - Wechselgarnitur Knopf gerade EDELSTAHL poliert



RZ - Garnitur EDELSTAHL poliert



PZ - Wechselgarnitur Knopf gekröpft EDELSTAHL poliert

Form 1024 auf Quadratrosette

| | Edelstahl matt | | Edelstahl poliert | | PVD Messinggelb | |
|---------------------------------------|------------------|---------------|-------------------|---------------|---------------------|---------------|
| | | € exkl. MwSt. | | € exkl. MwSt. | | € exkl. MwSt. |
| Rosettengarnitur | | | | | | |
| BB - Garnitur | PB3.0-Q10240 | 57,90 | PB3.0-QP10240 | 67,90 | PB3.0-QPVM10240 | 77,90 |
| PZ - Garnitur | PB3.0-Q10242 | 57,90 | PB3.0-QP10242 | 67,90 | PB3.0-QPVM10242 | 77,90 |
| OS - Garnitur (ohne Schlüsselrosette) | PB3.0-Q10240S | 53,90 | PB3.0-QP10240S | 63,90 | PB3.0-QPVM10240S | 73,90 |
| RZ - Garnitur | PB3.0-Q10248 | 57,90 | PB3.0-QP10248 | 67,90 | PB3.0-QPVM10248 | 77,90 |
| WC - Garnitur | PB3.0-Q10243 | 67,90 | PB3.0-QP10243 | 77,90 | PB3.0-QPVM10243 | 87,90 |
| WC - Garnitur rot/weiß Anz. | PB3.0-Q102431 | 71,90 | PB3.0-QP102431 | 81,90 | PB3.0-QPVM102431 | 91,90 |
| WC - Garnitur rot/grün Anz. | PB3.0-Q102432 | 71,90 | PB3.0-QP102432 | 81,90 | PB3.0-QPVM102432 | 91,90 |
| PZ-WG - Knopf ger. DIN R/L | PB3.0-Q10245/6 | 71,90 | PB3.0-QP10245/6 | 81,90 | PB3.0-QPVM10245/6 | 91,90 |
| PZ-WG - Knopf gekr. DIN R/L | PB3.0-Q102451/61 | 75,90 | PB3.0-QP102451/61 | 85,90 | PB3.0-QPVM102451/61 | 95,90 |
| Drückerpaar | | | | | | |
| ohne Rosetten | D10240 | 29,90 | DP10240 | 37,90 | DPVM10240 | 45,90 |

Standard-Türstärken: 38 - 42 mm
Aufpreis für Türstärken ab 42 mm: € 5,00

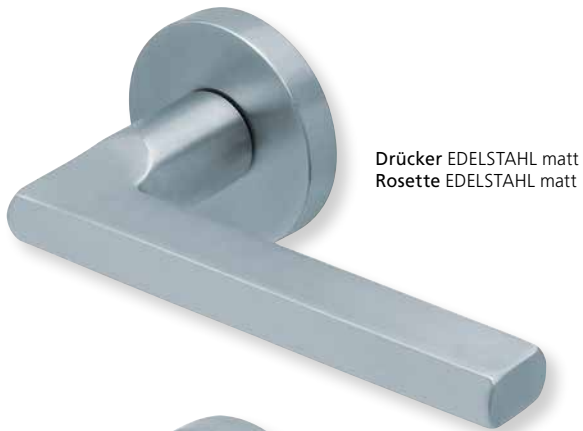

Drücker EDELSTAHL matt
Rosette EDELSTAHL matt



Drücker EDELSTAHL poliert
Rosette EDELSTAHL poliert

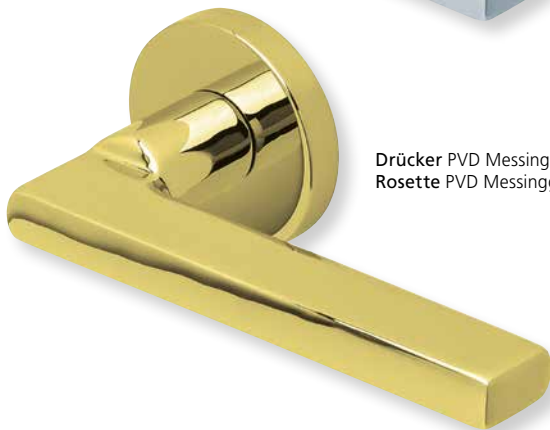

Drücker PVD Messinggelb
Rosette PVD Messinggelb

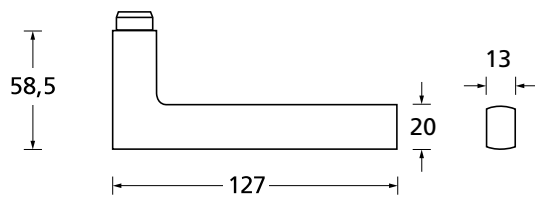



Pullbloc® 3.0 Kugellagertechnik



BB - Garnitur EDELSTAHL matt



PZ - Garnitur EDELSTAHL matt



WC - Garnitur EDELSTAHL matt
WC - Garnitur rot/weiß Anzeige EDELSTAHL matt
WC - Garnitur rot/grün Anzeige EDELSTAHL matt



PZ - Wechselgarnitur Knopf gerade EDELSTAHL matt



RZ - Garnitur EDELSTAHL matt



PZ - Wechselgarnitur Knopf gekröpft EDELSTAHL matt

Form 1025 auf Rundrosette

| | Edelstahl matt | | Edelstahl poliert | | PVD Messinggelb | |
|---------------------------------------|-----------------|-------|-------------------|-------|--------------------|-------|
| | € exkl. MwSt. | | € exkl. MwSt. | | € exkl. MwSt. | |
| Rosettengarnitur | | | | | | |
| BB - Garnitur | PB3.0-10250 | 51,90 | PB3.0-P10250 | 61,90 | PB3.0-PVM10250 | 71,90 |
| PZ - Garnitur | PB3.0-10252 | 51,90 | PB3.0-P10252 | 61,90 | PB3.0-PVM10252 | 71,90 |
| OS - Garnitur (ohne Schlüsselrosette) | PB3.0-1025OS | 47,90 | PB3.0-P1025OS | 57,90 | PB3.0-PVM1025OS | 67,90 |
| RZ - Garnitur | PB3.0-10258 | 51,90 | PB3.0-P10258 | 61,90 | PB3.0-PVM10258 | 71,90 |
| WC - Garnitur | PB3.0-10253 | 61,90 | PB3.0-P10253 | 71,90 | PB3.0-PVM10253 | 81,90 |
| WC - Garnitur rot/weiß Anz. | PB3.0-102531 | 65,90 | PB3.0-P102531 | 75,90 | PB3.0-PVM102531 | 85,90 |
| WC - Garnitur rot/grün Anz. | PB3.0-102532 | 65,90 | PB3.0-P102532 | 75,90 | PB3.0-PVM102532 | 85,90 |
| PZ-WG - Knopf ger. DIN R/L | PB3.0-10255/6 | 65,90 | PB3.0-P10255/6 | 75,90 | PB3.0-PVM10255/6 | 85,90 |
| PZ-WG - Knopf gekr. DIN R/L | PB3.0-102551/61 | 69,90 | PB3.0-P102551/61 | 79,90 | PB3.0-PVM102551/61 | 89,90 |
| Drückerpaar | | | | | | |
| ohne Rosetten | D10250 | 29,90 | DP10250 | 37,90 | DPVM10250 | 45,90 |

Standard-Türstärken: 38 - 42 mm
Aufpreis für Türstärken ab 42 mm: € 5,00

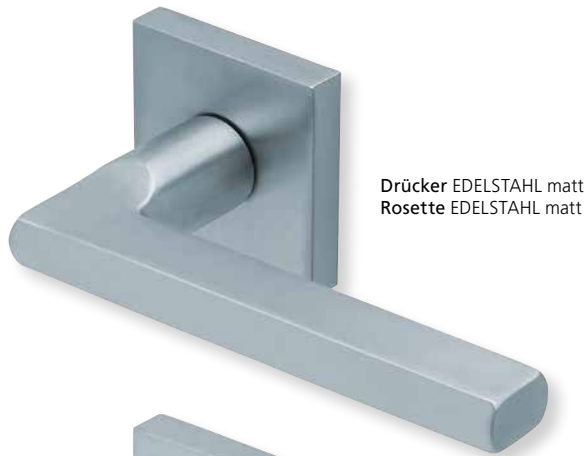

Drücker EDELSTAHL matt
Rosette EDELSTAHL matt



Drücker EDELSTAHL poliert
Rosette EDELSTAHL poliert

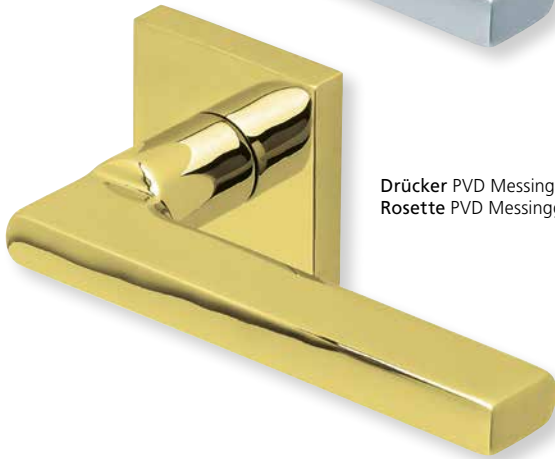

Drücker PVD Messinggelb
Rosette PVD Messinggelb

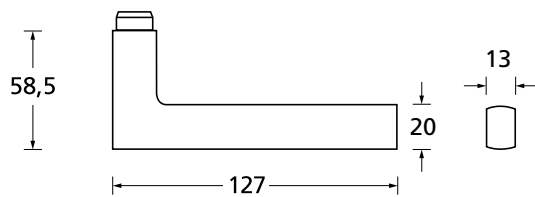



Pullbloc® 3.0 Kugellagertechnik



BB - Garnitur EDELSTAHL poliert



PZ - Garnitur EDELSTAHL poliert



WC - Garnitur EDELSTAHL poliert
WC - Garnitur rot/weiß Anzeige EDELSTAHL poliert
WC - Garnitur rot/grün Anzeige EDELSTAHL poliert



PZ - Wechselgarnitur Knopf gerade
EDELSTAHL poliert



RZ - Garnitur EDELSTAHL poliert



PZ - Wechselgarnitur Knopf gekröpft
EDELSTAHL poliert

Form 1025 auf Quadratrosette

| | Edelstahl matt | | Edelstahl poliert | | PVD Messinggelb | |
|---------------------------------------|------------------|-------|-------------------|-------|---------------------|-------|
| | € exkl. MwSt. | | € exkl. MwSt. | | € exkl. MwSt. | |
| Rosettengarnitur | | | | | | |
| BB - Garnitur | PB3.0-Q10250 | 57,90 | PB3.0-QP10250 | 67,90 | PB3.0-QPVM10250 | 77,90 |
| PZ - Garnitur | PB3.0-Q10252 | 57,90 | PB3.0-QP10252 | 67,90 | PB3.0-QPVM10252 | 77,90 |
| OS - Garnitur (ohne Schlüsselrosette) | PB3.0-Q10250S | 53,90 | PB3.0-QP10250S | 63,90 | PB3.0-QPVM10250S | 73,90 |
| RZ - Garnitur | PB3.0-Q10258 | 57,90 | PB3.0-QP10258 | 67,90 | PB3.0-QPVM10258 | 77,90 |
| WC - Garnitur | PB3.0-Q10253 | 67,90 | PB3.0-QP10253 | 77,90 | PB3.0-QPVM10253 | 87,90 |
| WC - Garnitur rot/weiß Anz. | PB3.0-Q102531 | 71,90 | PB3.0-QP102531 | 81,90 | PB3.0-QPVM102531 | 91,90 |
| WC - Garnitur rot/grün Anz. | PB3.0-Q102532 | 71,90 | PB3.0-QP102532 | 81,90 | PB3.0-QPVM102532 | 91,90 |
| PZ-WG - Knopf ger. DIN R/L | PB3.0-Q10255/6 | 71,90 | PB3.0-QP10255/6 | 81,90 | PB3.0-QPVM10255/6 | 91,90 |
| PZ-WG - Knopf gekr. DIN R/L | PB3.0-Q102551/61 | 75,90 | PB3.0-QP102551/61 | 85,90 | PB3.0-QPVM102551/61 | 95,90 |
| Drückerpaar | | | | | | |
| ohne Rosetten | D10250 | 29,90 | DP10250 | 37,90 | DPVM10250 | 45,90 |

Standard-Türstärken: 38 - 42 mm
Aufpreis für Türstärken ab 42 mm: € 5,00



Drücker EDELSTAHL matt
Rosette EDELSTAHL matt



Drücker EDELSTAHL poliert
Rosette EDELSTAHL poliert



Drücker PVD Messinggelb
Rosette PVD Messinggelb

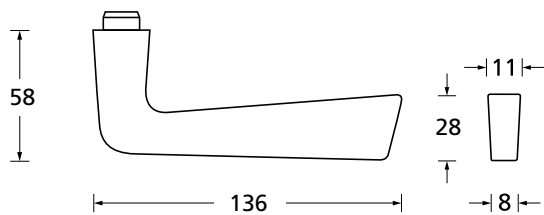



Pullbloc® 3.0 Kugellagertechnik



BB - Garnitur EDELSTAHL matt



PZ - Garnitur EDELSTAHL matt



WC - Garnitur EDELSTAHL matt
WC - Garnitur rot/weiß Anzeige EDELSTAHL matt
WC - Garnitur rot/grün Anzeige EDELSTAHL matt



PZ - Wechselgarnitur Knopf gerade
EDELSTAHL matt



RZ - Garnitur EDELSTAHL matt



PZ - Wechselgarnitur Knopf gekröpft
EDELSTAHL matt

Form 1026 auf Rundrosette

| | Edelstahl matt | | Edelstahl poliert | | PVD Messinggelb | |
|---------------------------------------|-----------------|-------|-------------------|-------|--------------------|-------|
| | € exkl. MwSt. | | € exkl. MwSt. | | € exkl. MwSt. | |
| Rosettengarnitur | | | | | | |
| BB - Garnitur | PB3.0-10260 | 51,90 | PB3.0-P10260 | 61,90 | PB3.0-PVM10260 | 71,90 |
| PZ - Garnitur | PB3.0-10262 | 51,90 | PB3.0-P10262 | 61,90 | PB3.0-PVM10262 | 71,90 |
| OS - Garnitur (ohne Schlüsselrosette) | PB3.0-1026OS | 47,90 | PB3.0-P1026OS | 57,90 | PB3.0-PVM1026OS | 67,90 |
| RZ - Garnitur | PB3.0-10268 | 51,90 | PB3.0-P10268 | 61,90 | PB3.0-PVM10268 | 71,90 |
| WC - Garnitur | PB3.0-10263 | 61,90 | PB3.0-P10263 | 71,90 | PB3.0-PVM10263 | 81,90 |
| WC - Garnitur rot/weiß Anz. | PB3.0-102631 | 65,90 | PB3.0-P102631 | 75,90 | PB3.0-PVM102631 | 85,90 |
| WC - Garnitur rot/grün Anz. | PB3.0-102632 | 65,90 | PB3.0-P102632 | 75,90 | PB3.0-PVM102632 | 85,90 |
| PZ-WG - Knopf ger. DIN R/L | PB3.0-10265/6 | 65,90 | PB3.0-P10265/6 | 75,90 | PB3.0-PVM10265/6 | 85,90 |
| PZ-WG - Knopf gekr. DIN R/L | PB3.0-102651/61 | 69,90 | PB3.0-P102651/61 | 79,90 | PB3.0-PVM102651/61 | 89,90 |
| Drückerpaar | | | | | | |
| ohne Rosetten | D10260 | 29,90 | DP10260 | 37,90 | DPVM10260 | 45,90 |

Standard-Türstärken: 38 - 42 mm
Aufpreis für Türstärken ab 42 mm: € 5,00



Drücker EDELSTAHL matt
Rosette EDELSTAHL matt



Drücker EDELSTAHL poliert
Rosette EDELSTAHL poliert



Drücker PVD Messinggelb
Rosette PVD Messinggelb

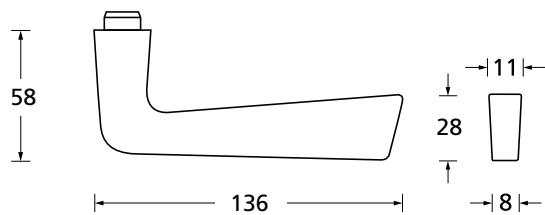



Pullbloc® 3.0 Kugellagertechnik



BB - Garnitur EDELSTAHL poliert



PZ - Garnitur EDELSTAHL poliert



WC - Garnitur EDELSTAHL poliert
WC - Garnitur rot/weiß Anzeige EDELSTAHL poliert
WC - Garnitur rot/grün Anzeige EDELSTAHL poliert



PZ - Wechselgarnitur Knopf gerade
EDELSTAHL poliert



RZ - Garnitur EDELSTAHL poliert



PZ - Wechselgarnitur Knopf gekröpft
EDELSTAHL poliert

Form 1026 auf Quadratrosette

| | Edelstahl matt | | Edelstahl poliert | | PVD Messinggelb | |
|---------------------------------------|------------------|-------|-------------------|-------|---------------------|-------|
| | € exkl. MwSt. | | € exkl. MwSt. | | € exkl. MwSt. | |
| Rosettengarnitur | | | | | | |
| BB - Garnitur | PB3.0-Q10260 | 57,90 | PB3.0-QP10260 | 67,90 | PB3.0-QPVM10260 | 77,90 |
| PZ - Garnitur | PB3.0-Q10262 | 57,90 | PB3.0-QP10262 | 67,90 | PB3.0-QPVM10262 | 77,90 |
| OS - Garnitur (ohne Schlüsselrosette) | PB3.0-Q10260S | 53,90 | PB3.0-QP10260S | 63,90 | PB3.0-QPVM10260S | 73,90 |
| RZ - Garnitur | PB3.0-Q10268 | 57,90 | PB3.0-QP10268 | 67,90 | PB3.0-QPVM10268 | 77,90 |
| WC - Garnitur | PB3.0-Q10263 | 67,90 | PB3.0-QP10263 | 77,90 | PB3.0-QPVM10263 | 87,90 |
| WC - Garnitur rot/weiß Anz. | PB3.0-Q102631 | 71,90 | PB3.0-QP102631 | 81,90 | PB3.0-QPVM102631 | 91,90 |
| WC - Garnitur rot/grün Anz. | PB3.0-Q102632 | 71,90 | PB3.0-QP102632 | 81,90 | PB3.0-QPVM102632 | 91,90 |
| PZ-WG - Knopf ger. DIN R/L | PB3.0-Q10265/6 | 71,90 | PB3.0-QP10265/6 | 81,90 | PB3.0-QPVM10265/6 | 91,90 |
| PZ-WG - Knopf gekr. DIN R/L | PB3.0-Q102651/61 | 75,90 | PB3.0-QP102651/61 | 85,90 | PB3.0-QPVM102651/61 | 95,90 |
| Drückerpaar | | | | | | |
| ohne Rosetten | D10260 | 29,90 | DP10260 | 37,90 | DPVM10260 | 45,90 |

Standard-Türstärken: 38 - 42 mm
Aufpreis für Türstärken ab 42 mm: € 5,00



Drücker EDELSTAHL matt
Rosette EDELSTAHL matt



Drücker EDELSTAHL poliert
Rosette EDELSTAHL poliert

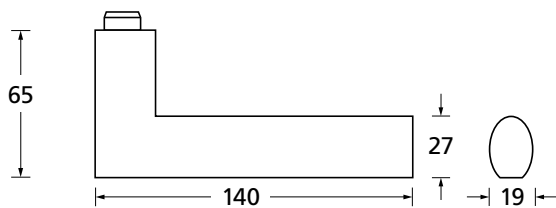



Pullbloc® 3.0 Kugellagertechnik

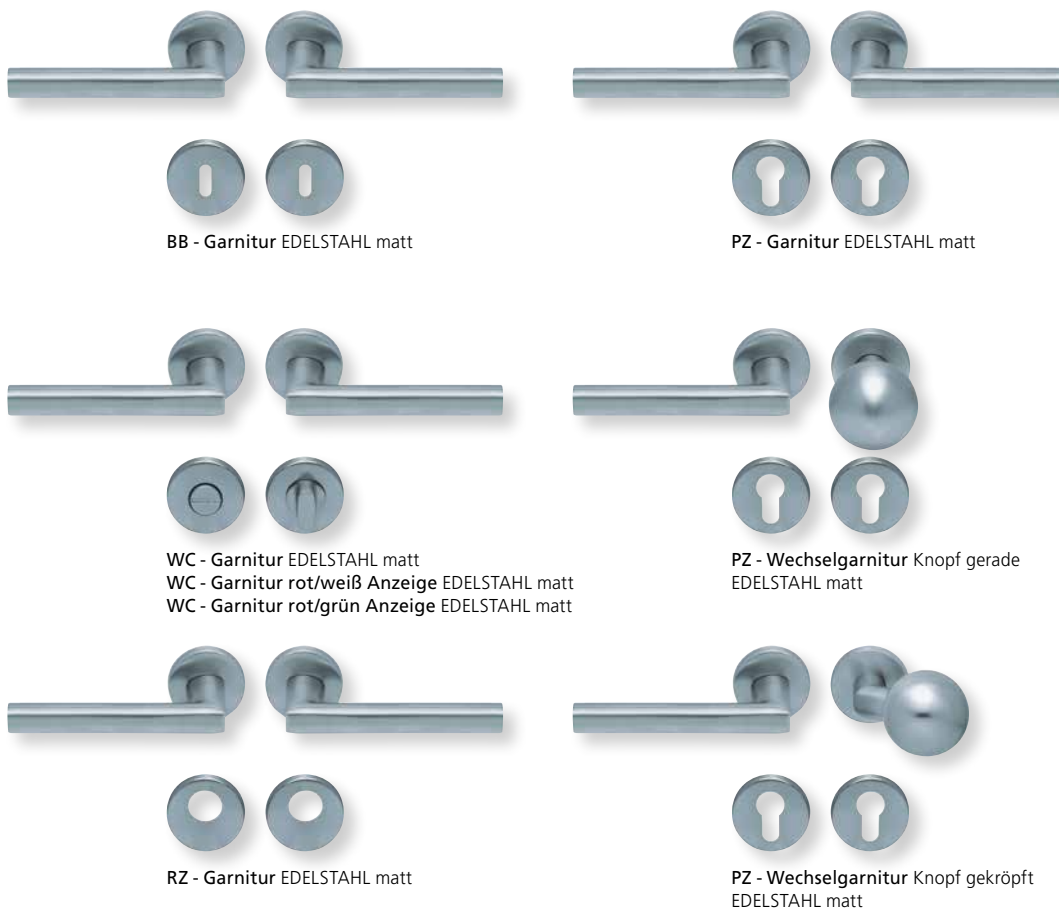

Form 1027 auf Rundrosette

| | Edelstahl matt | | Edelstahl poliert | |
|---------------------------------------|-----------------|---------------|-------------------|---------------|
| | | € exkl. MwSt. | | € exkl. MwSt. |
| Rosettengarnitur | | | | |
| BB - Garnitur | PB3.0-10270 | 51,90 | PB3.0-P10270 | 61,90 |
| PZ - Garnitur | PB3.0-10272 | 51,90 | PB3.0-P10272 | 61,90 |
| OS - Garnitur (ohne Schlüsselrosette) | PB3.0-1027OS | 47,90 | PB3.0-P1027OS | 57,90 |
| RZ - Garnitur | PB3.0-10278 | 51,90 | PB3.0-P10278 | 61,90 |
| WC - Garnitur | PB3.0-10273 | 61,90 | PB3.0-P10273 | 71,90 |
| WC - Garnitur rot/weiß Anz. | PB3.0-102731 | 65,90 | PB3.0-P102731 | 75,90 |
| WC - Garnitur rot/grün Anz. | PB3.0-102732 | 65,90 | PB3.0-P102732 | 75,90 |
| PZ-WG - Knopf ger. DIN R/L | PB3.0-10275/6 | 65,90 | PB3.0-P10275/6 | 75,90 |
| PZ-WG - Knopf gekr. DIN R/L | PB3.0-102751/61 | 69,90 | PB3.0-P102751/61 | 79,90 |
| Drückerpaar | | | | |
| ohne Rosetten | D10270 | 29,90 | DP10270 | 37,90 |

Standard-Türstärken: 38 - 42 mm
Aufpreis für Türstärken ab 42 mm: € 5,00



Drücker EDELSTAHL matt
Rosette EDELSTAHL matt



Drücker EDELSTAHL poliert
Rosette EDELSTAHL poliert

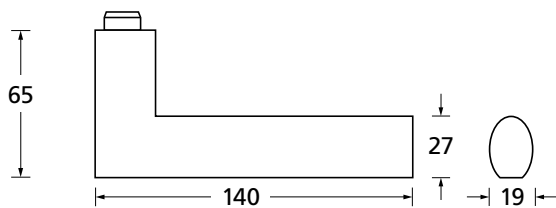



Pullbloc® 3.0 Kugellagertechnik

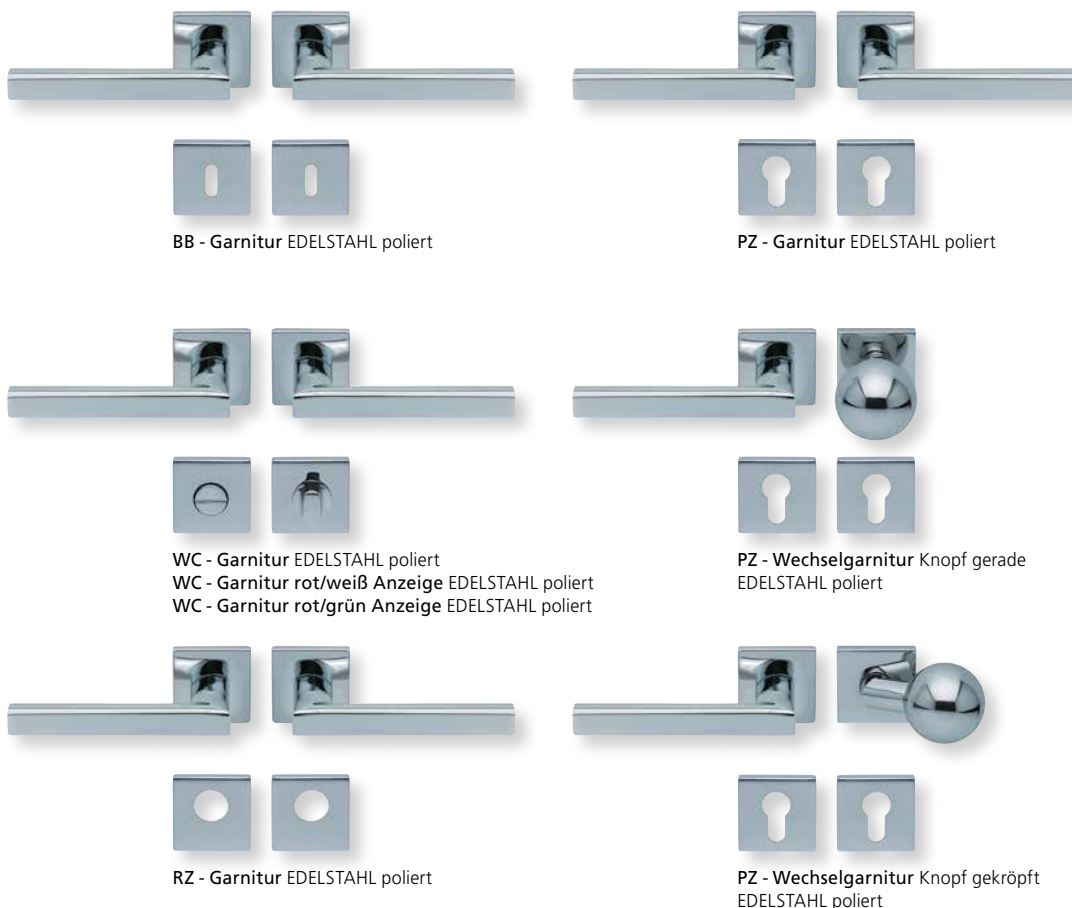

BB - Garnitur EDELSTAHL poliert

PZ - Garnitur EDELSTAHL poliert

WC - Garnitur EDELSTAHL poliert
WC - Garnitur rot/weiß Anzeige EDELSTAHL poliert
WC - Garnitur rot/grün Anzeige EDELSTAHL poliert

PZ - Wechselgarnitur Knopf gerade EDELSTAHL poliert

RZ - Garnitur EDELSTAHL poliert

PZ - Wechselgarnitur Knopf gekröpft EDELSTAHL poliert

Form 1027 auf Quadratrosette

| | Edelstahl matt | | Edelstahl poliert | |
|---------------------------------------|------------------|-------|-------------------|-------|
| | € exkl. MwSt. | | € exkl. MwSt. | |
| Rosettengarnitur | | | | |
| BB - Garnitur | PB3.0-Q10270 | 57,90 | PB3.0-QP10270 | 67,90 |
| PZ - Garnitur | PB3.0-Q10272 | 57,90 | PB3.0-QP10272 | 67,90 |
| OS - Garnitur (ohne Schlüsselrosette) | PB3.0-Q10270S | 53,90 | PB3.0-QP10270S | 63,90 |
| RZ - Garnitur | PB3.0-Q10278 | 57,90 | PB3.0-QP10278 | 67,90 |
| WC - Garnitur | PB3.0-Q10273 | 67,90 | PB3.0-QP10273 | 77,90 |
| WC - Garnitur rot/weiß Anz. | PB3.0-Q102731 | 71,90 | PB3.0-QP102731 | 81,90 |
| WC - Garnitur rot/grün Anz. | PB3.0-Q102732 | 71,90 | PB3.0-QP102732 | 81,90 |
| PZ-WG - Knopf ger. DIN R/L | PB3.0-Q10275/6 | 71,90 | PB3.0-QP10275/6 | 81,90 |
| PZ-WG - Knopf gekr. DIN R/L | PB3.0-Q102751/61 | 75,90 | PB3.0-QP102751/61 | 85,90 |
| Drückerpaar | | | | |
| ohne Rosetten | D10270 | 29,90 | DP10270 | 37,90 |

Standard-Türstärken: 38 - 42 mm
Aufpreis für Türstärken ab 42 mm: € 5,00

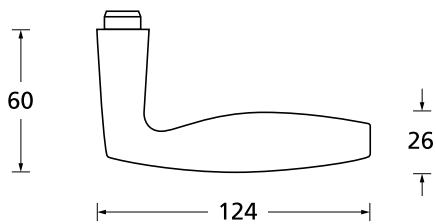



Pullbloc® 3.0 Kugellagertechnik



BB - Garnitur EDELSTAHL matt



PZ - Garnitur EDELSTAHL matt



WC - Garnitur EDELSTAHL matt
WC - Garnitur rot/weiß Anzeige EDELSTAHL matt
WC - Garnitur rot/grün Anzeige EDELSTAHL matt



PZ - Wechselgarnitur Knopf gerade EDELSTAHL matt



RZ - Garnitur EDELSTAHL matt



PZ - Wechselgarnitur Knopf gekröpft EDELSTAHL matt

Form 1062 auf Rundrosette

Edelstahl matt

Rosettengarnitur

| | | € exkl. MwSt. |
|---------------------------------------|-----------------|---------------|
| BB - Garnitur | PB3.0-10620 | 51,90 |
| PZ - Garnitur | PB3.0-10622 | 51,90 |
| OS - Garnitur (ohne Schlüsselrosette) | PB3.0-10620S | 47,90 |
| RZ - Garnitur | PB3.0-10628 | 51,90 |
| WC - Garnitur | PB3.0-10623 | 61,90 |
| WC - Garnitur rot/weiß Anz. | PB3.0-106231 | 65,90 |
| WC - Garnitur rot/grün Anz. | PB3.0-106232 | 65,90 |
| PZ-WG - Knopf ger. DIN R/L | PB3.0-10625/6 | 65,90 |
| PZ-WG - Knopf gekr. DIN R/L | PB3.0-106251/61 | 69,90 |

Drückerpaar

| | | |
|---------------|--------|-------|
| ohne Rosetten | D10620 | 29,90 |
|---------------|--------|-------|

Standard-Türstärken: 38 - 42 mm
Aufpreis für Türstärken ab 42 mm: € 5,00

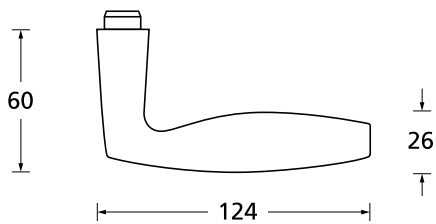



Pullbloc® 3.0 Kugellagertechnik



BB - Garnitur EDELSTAHL matt



PZ - Garnitur EDELSTAHL matt



WC - Garnitur EDELSTAHL matt
WC - Garnitur rot/weiß Anzeige EDELSTAHL matt
WC - Garnitur rot/grün Anzeige EDELSTAHL matt

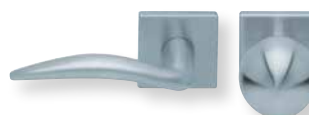

PZ - Wechselgarnitur Knopf gerade
EDELSTAHL matt



RZ - Garnitur EDELSTAHL matt

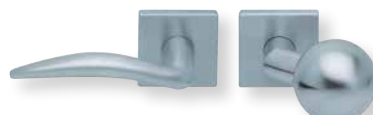

PZ - Wechselgarnitur Knopf gekröpft
EDELSTAHL matt

Form 1062 auf Quadratrosette

Edelstahl matt

Rosettengarnitur

| | | € exkl. MwSt. |
|---------------------------------------|------------------|---------------|
| BB - Garnitur | PB3.0-Q10620 | 57,90 |
| PZ - Garnitur | PB3.0-Q10622 | 57,90 |
| OS - Garnitur (ohne Schlüsselrosette) | PB3.0-Q10620S | 53,90 |
| RZ - Garnitur | PB3.0-Q10628 | 57,90 |
| WC - Garnitur | PB3.0-Q10623 | 67,90 |
| WC - Garnitur rot/weiß Anz. | PB3.0-Q106231 | 71,90 |
| WC - Garnitur rot/grün Anz. | PB3.0-Q106232 | 71,90 |
| PZ-WG - Knopf ger. DIN R/L | PB3.0-Q10625/6 | 71,90 |
| PZ-WG - Knopf gekr. DIN R/L | PB3.0-Q106251/61 | 75,90 |

Drückerpaar

| | | |
|---------------|--------|-------|
| ohne Rosetten | D10620 | 29,90 |
|---------------|--------|-------|

Standard-Türstärken: 38 - 42 mm
Aufpreis für Türstärken ab 42 mm: € 5,00



Drücker EDELSTAHL matt
Rosette EDELSTAHL matt

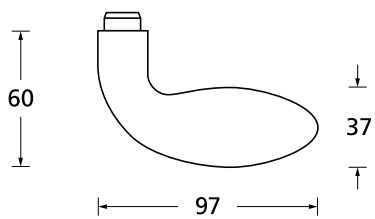



Pullbloc® 3.0 Kugellagertechnik

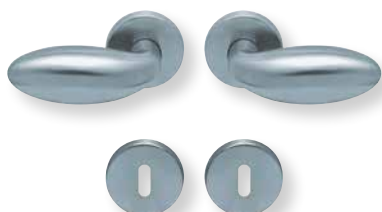

BB - Garnitur EDELSTAHL matt

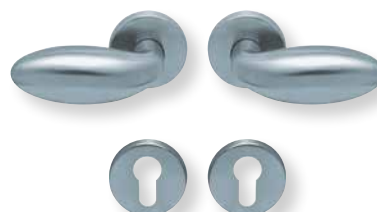

PZ - Garnitur EDELSTAHL matt



WC - Garnitur EDELSTAHL matt
WC - Garnitur rot/weiß Anzeige EDELSTAHL matt
WC - Garnitur rot/grün Anzeige EDELSTAHL matt



PZ - Wechselgarnitur Knopf gerade EDELSTAHL matt



RZ - Garnitur EDELSTAHL matt



PZ - Wechselgarnitur Knopf gekröpft EDELSTAHL matt

Form 1066 auf Rundrosette

Edelstahl matt

Rosettengarnitur

| | | € exkl. MwSt. |
|---------------------------------------|-----------------|---------------|
| BB - Garnitur | PB3.0-10660 | 51,90 |
| PZ - Garnitur | PB3.0-10662 | 51,90 |
| OS - Garnitur (ohne Schlüsselrosette) | PB3.0-10660S | 47,90 |
| RZ - Garnitur | PB3.0-10668 | 51,90 |
| WC - Garnitur | PB3.0-10663 | 61,90 |
| WC - Garnitur rot/weiß Anz. | PB3.0-106631 | 65,90 |
| WC - Garnitur rot/grün Anz. | PB3.0-106632 | 65,90 |
| PZ-WG - Knopf ger. DIN R/L | PB3.0-10665/6 | 65,90 |
| PZ-WG - Knopf gekr. DIN R/L | PB3.0-106651/61 | 69,90 |

Drückerpaar

| | | |
|---------------|--------|-------|
| ohne Rosetten | D10660 | 29,90 |
|---------------|--------|-------|

Standard-Türstärken: 38 - 42 mm
Aufpreis für Türstärken ab 42 mm: € 5,00



Drücker EDELSTAHL matt
Rosette EDELSTAHL matt

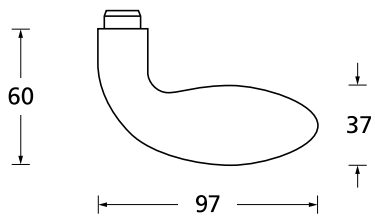



Pullbloc® 3.0 Kugellagertechnik



BB - Garnitur EDELSTAHL matt



PZ - Garnitur EDELSTAHL matt



WC - Garnitur EDELSTAHL matt
WC - Garnitur rot/weiß Anzeige EDELSTAHL matt
WC - Garnitur rot/grün Anzeige EDELSTAHL matt



PZ - Wechselgarnitur Knopf gerade EDELSTAHL matt



RZ - Garnitur EDELSTAHL matt



PZ - Wechselgarnitur Knopf gekröpft EDELSTAHL matt

Form 1066 auf Quadratrosette

Edelstahl matt

Rosettengarnitur

| | | € exkl. MwSt. |
|---------------------------------------|------------------|---------------|
| BB - Garnitur | PB3.0-Q10660 | 57,90 |
| PZ - Garnitur | PB3.0-Q10662 | 57,90 |
| OS - Garnitur (ohne Schlüsselrosette) | PB3.0-Q10660S | 53,90 |
| RZ - Garnitur | PB3.0-Q10668 | 57,90 |
| WC - Garnitur | PB3.0-Q10663 | 67,90 |
| WC - Garnitur rot/weiß Anz. | PB3.0-Q106631 | 71,90 |
| WC - Garnitur rot/grün Anz. | PB3.0-Q106632 | 71,90 |
| PZ-WG - Knopf ger. DIN R/L | PB3.0-Q10665/6 | 71,90 |
| PZ-WG - Knopf gekr. DIN R/L | PB3.0-Q106651/61 | 75,90 |

Drückerpaar

| | | |
|---------------|--------|-------|
| ohne Rosetten | D10660 | 29,90 |
|---------------|--------|-------|

Standard-Türstärken: 38 - 42 mm
Aufpreis für Türstärken ab 42 mm: € 5,00



Drücker EDELSTAHL matt
Rosette EDELSTAHL matt



Drücker EDELSTAHL poliert
Rosette EDELSTAHL poliert

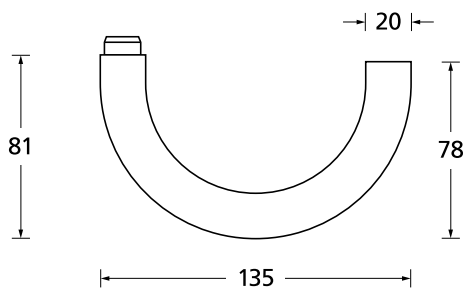



Pullbloc® 3.0 Kugellagertechnik

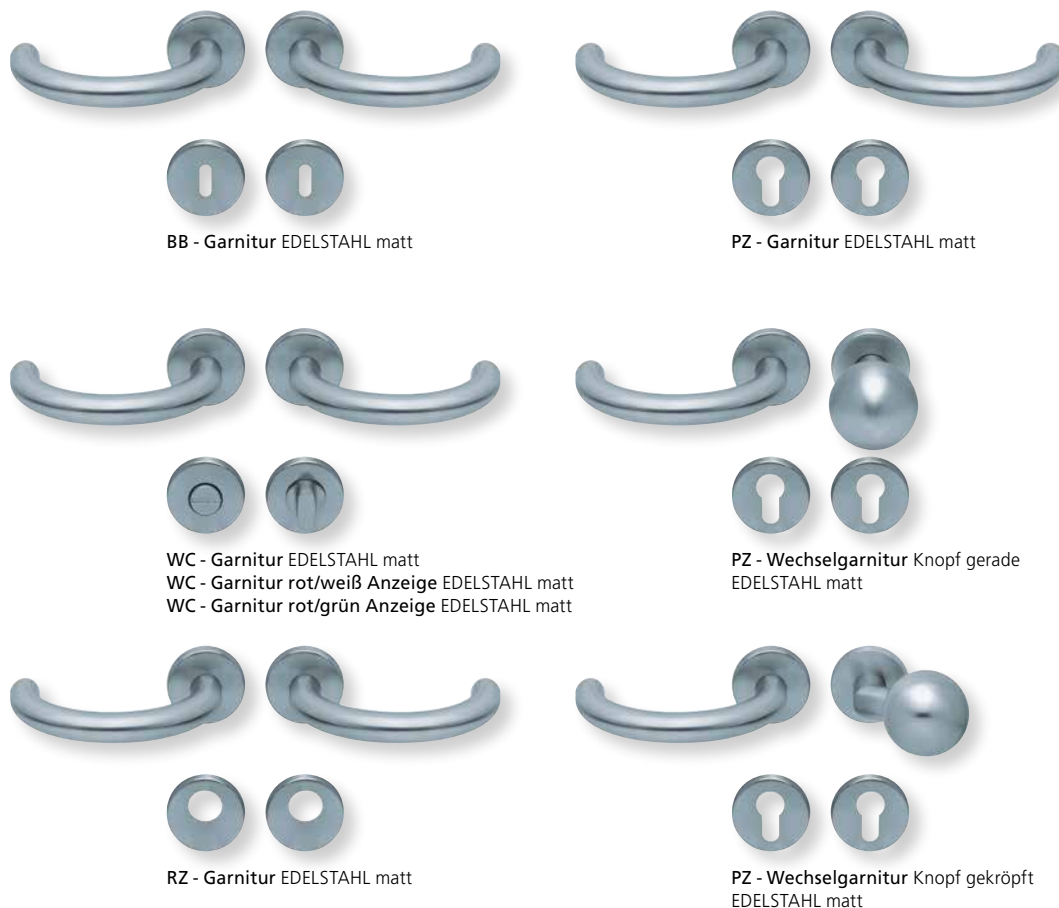

Form 1070 auf Rundrosette

| | Edelstahl matt | | Edelstahl poliert | |
|---------------------------------------|-----------------|---------------|-------------------|---------------|
| | | € exkl. MwSt. | | € exkl. MwSt. |
| Rosettengarnitur | | | | |
| BB - Garnitur | PB3.0-10700 | 45,90 | PB3.0-P10700 | 55,90 |
| PZ - Garnitur | PB3.0-10702 | 45,90 | PB3.0-P10702 | 55,90 |
| OS - Garnitur (ohne Schlüsselrosette) | PB3.0-10700S | 41,90 | PB3.0-P10700S | 51,90 |
| RZ - Garnitur | PB3.0-10708 | 45,90 | PB3.0-P10708 | 55,90 |
| WC - Garnitur | PB3.0-10703 | 55,90 | PB3.0-P10703 | 65,90 |
| WC - Garnitur rot/weiß Anz. | PB3.0-107031 | 59,90 | PB3.0-P107031 | 69,90 |
| WC - Garnitur rot/grün Anz. | PB3.0-107032 | 59,90 | PB3.0-P107032 | 69,90 |
| PZ-WG - Knopf ger. DIN R/L | PB3.0-10705/6 | 59,90 | PB3.0-P10705/6 | 69,90 |
| PZ-WG - Knopf gekr. DIN R/L | PB3.0-107051/61 | 63,90 | PB3.0-P107051/61 | 73,90 |
| Drückerpaar | | | | |
| ohne Rosetten | D10700 | 25,90 | DP10700 | 33,90 |

Standard-Türstärken: 38 - 42 mm
 Aufpreis für Türstärken ab 42 mm: € 5,00

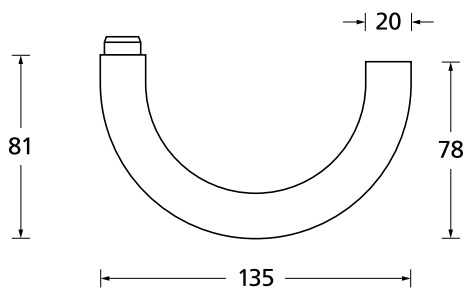



Pullbloc® 3.0 Kugellagertechnik



BB - Garnitur EDELSTAHL poliert



PZ - Garnitur EDELSTAHL poliert



WC - Garnitur EDELSTAHL poliert
WC - Garnitur rot/weiß Anzeige EDELSTAHL poliert
WC - Garnitur rot/grün Anzeige EDELSTAHL poliert



PZ - Wechselgarnitur Knopf gerade EDELSTAHL poliert



RZ - Garnitur EDELSTAHL poliert



PZ - Wechselgarnitur Knopf gekröpft EDELSTAHL poliert

Form 1070 auf Quadratrosette

| Rosettengarnitur | Edelstahl matt | | Edelstahl poliert | |
|---------------------------------------|------------------|---------------|-------------------|---------------|
| | | € exkl. MwSt. | | € exkl. MwSt. |
| BB - Garnitur | PB3.0-Q10700 | 51,90 | PB3.0-QP10700 | 61,90 |
| PZ - Garnitur | PB3.0-Q10702 | 51,90 | PB3.0-QP10702 | 61,90 |
| OS - Garnitur (ohne Schlüsselrosette) | PB3.0-Q10700S | 47,90 | PB3.0-QP10700S | 57,90 |
| RZ - Garnitur | PB3.0-Q10708 | 51,90 | PB3.0-QP10708 | 61,90 |
| WC - Garnitur | PB3.0-Q10703 | 61,90 | PB3.0-QP10703 | 71,90 |
| WC - Garnitur rot/weiß Anz. | PB3.0-Q107031 | 65,90 | PB3.0-QP107031 | 75,90 |
| WC - Garnitur rot/grün Anz. | PB3.0-Q107032 | 65,90 | PB3.0-QP107032 | 75,90 |
| PZ-WG - Knopf ger. DIN R/L | PB3.0-Q10705/6 | 65,90 | PB3.0-QP10705/6 | 75,90 |
| PZ-WG - Knopf gekr. DIN R/L | PB3.0-Q107051/61 | 69,90 | PB3.0-QP107051/61 | 79,90 |
| Drückerpaar | | | | |
| ohne Rosetten | D10700 | 25,90 | DP10700 | 33,90 |

Standard-Türstärken: 38 - 42 mm
Aufpreis für Türstärken ab 42 mm: € 5,00



Drücker EDELSTAHL matt
Rosette EDELSTAHL matt



Drücker EDELSTAHL poliert
Rosette EDELSTAHL poliert

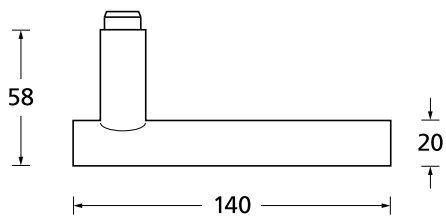



Pullbloc® 3.0 Kugellagertechnik

119



BB - Garnitur EDELSTAHL matt



PZ - Garnitur EDELSTAHL matt



WC - Garnitur EDELSTAHL matt
WC - Garnitur rot/weiß Anzeige EDELSTAHL matt
WC - Garnitur rot/grün Anzeige EDELSTAHL matt



PZ - Wechselgarnitur Knopf gerade
EDELSTAHL matt



RZ - Garnitur EDELSTAHL matt

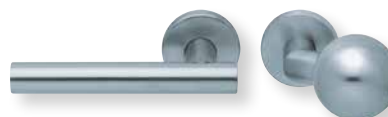

PZ - Wechselgarnitur Knopf gekröpft
EDELSTAHL matt

Form 1074 auf Rundrosette

| | Edelstahl matt | | Edelstahl poliert | |
|---------------------------------------|-----------------|---------------|-------------------|---------------|
| | | € exkl. MwSt. | | € exkl. MwSt. |
| Rosettengarnitur | | | | |
| BB - Garnitur | PB3.0-10740 | 39,90 | PB3.0-P10740 | 49,90 |
| PZ - Garnitur | PB3.0-10742 | 39,90 | PB3.0-P10742 | 49,90 |
| OS - Garnitur (ohne Schlüsselrosette) | PB3.0-1074OS | 35,90 | PB3.0-P1074OS | 45,90 |
| RZ - Garnitur | PB3.0-10748 | 39,90 | PB3.0-P10748 | 49,90 |
| WC - Garnitur | PB3.0-10743 | 49,90 | PB3.0-P10743 | 59,90 |
| WC - Garnitur rot/weiß Anz. | PB3.0-107431 | 53,90 | PB3.0-P107431 | 63,90 |
| WC - Garnitur rot/grün Anz. | PB3.0-107432 | 53,90 | PB3.0-P107432 | 63,90 |
| PZ-WG - Knopf ger. DIN R/L | PB3.0-10745/6 | 53,90 | PB3.0-P10745/6 | 63,90 |
| PZ-WG - Knopf gekr. DIN R/L | PB3.0-107451/61 | 57,90 | PB3.0-P107451/61 | 67,90 |
| Drückerpaar | | | | |
| ohne Rosetten | D10740 | 19,90 | DP10740 | 27,90 |

Standard-Türstärken: 38 - 42 mm
Aufpreis für Türstärken ab 42 mm: € 5,00

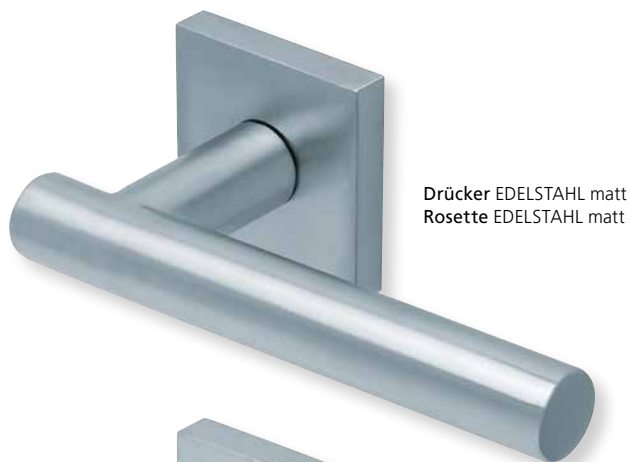

Drücker EDELSTAHL matt
Rosette EDELSTAHL matt



Drücker EDELSTAHL poliert
Rosette EDELSTAHL poliert

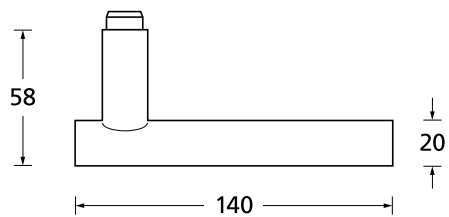



Pullbloc® 3.0 Kugellagertechnik



BB - Garnitur EDELSTAHL poliert



PZ - Garnitur EDELSTAHL poliert



WC - Garnitur EDELSTAHL poliert
WC - Garnitur rot/weiß Anzeige EDELSTAHL poliert
WC - Garnitur rot/grün Anzeige EDELSTAHL poliert



PZ - Wechselgarnitur Knopf gerade
EDELSTAHL poliert



RZ - Garnitur EDELSTAHL poliert



PZ - Wechselgarnitur Knopf gekröpft
EDELSTAHL poliert

Form 1074 auf Quadratrosette

| Rosettengarnitur | Edelstahl matt | | Edelstahl poliert | |
|---------------------------------------|------------------|---------------|-------------------|---------------|
| | | € exkl. MwSt. | | € exkl. MwSt. |
| BB - Garnitur | PB3.0-Q10740 | 45,90 | PB3.0-QP10740 | 55,90 |
| PZ - Garnitur | PB3.0-Q10742 | 45,90 | PB3.0-QP10742 | 55,90 |
| OS - Garnitur (ohne Schlüsselrosette) | PB3.0-Q10740S | 41,90 | PB3.0-QP10740S | 51,90 |
| RZ - Garnitur | PB3.0-Q10748 | 45,90 | PB3.0-QP10748 | 55,90 |
| WC - Garnitur | PB3.0-Q10743 | 55,90 | PB3.0-QP10743 | 65,90 |
| WC - Garnitur rot/weiß Anz. | PB3.0-Q107431 | 59,90 | PB3.0-QP107431 | 69,90 |
| WC - Garnitur rot/grün Anz. | PB3.0-Q107432 | 59,90 | PB3.0-QP107432 | 69,90 |
| PZ-WG - Knopf ger. DIN R/L | PB3.0-Q10745/6 | 59,90 | PB3.0-QP10745/6 | 69,90 |
| PZ-WG - Knopf gekr. DIN R/L | PB3.0-Q107451/61 | 63,90 | PB3.0-QP107451/61 | 73,90 |
| Drückerpaar | | | | |
| ohne Rosetten | D10740 | 19,90 | DP10740 | 27,90 |

Standard-Türstärken: 38 - 42 mm
Aufpreis für Türstärken ab 42 mm: € 5,00



Drücker EDELSTAHL matt
Rosette EDELSTAHL matt



Drücker EDELSTAHL poliert
Rosette EDELSTAHL poliert



Drücker PVD Messinggelb
Rosette PVD Messinggelb

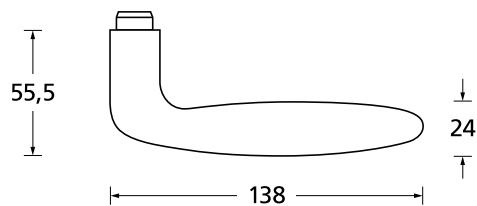



Pullbloc® 3.0 Kugellagertechnik

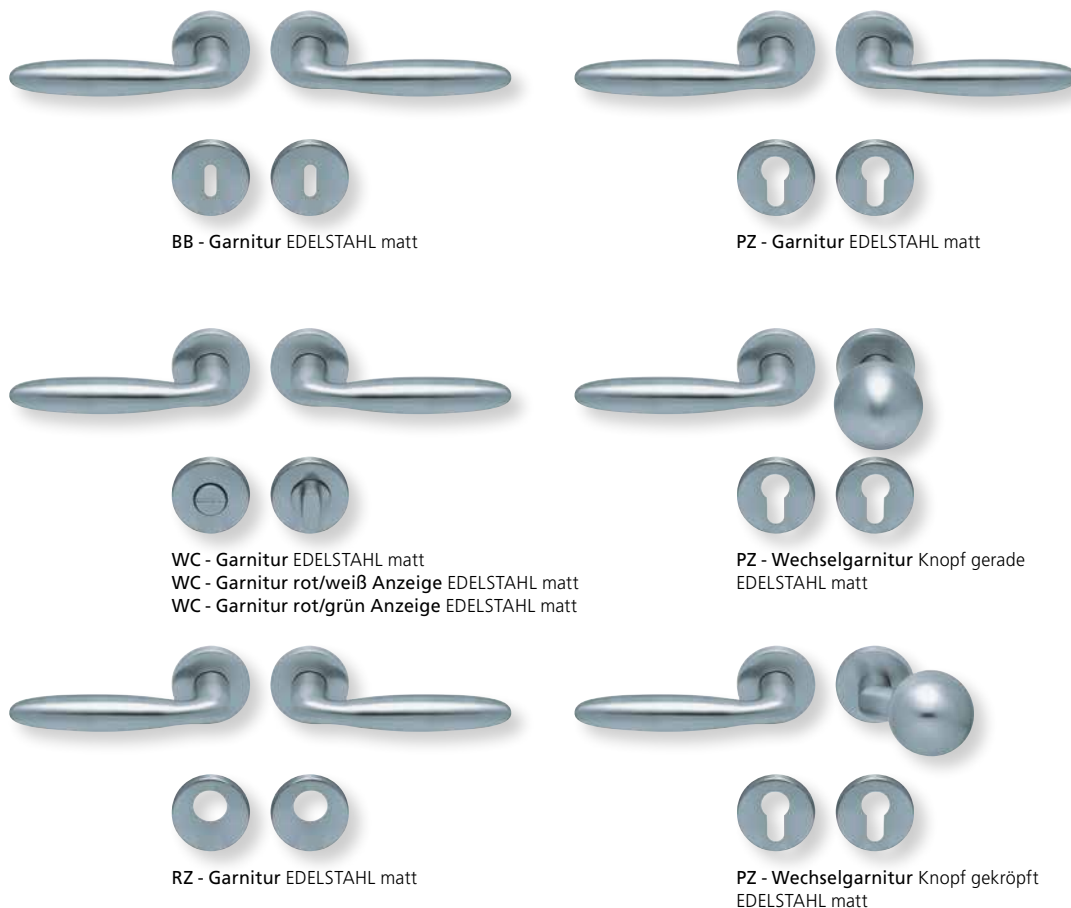

Form 1083 auf Rundrosette

| | Edelstahl matt | | Edelstahl poliert | | PVD Messinggelb | |
|---------------------------------------|-----------------|-------|-------------------|-------|--------------------|-------|
| | € exkl. MwSt. | | € exkl. MwSt. | | € exkl. MwSt. | |
| Rosettengarnitur | | | | | | |
| BB - Garnitur | PB3.0-10830 | 45,90 | PB3.0-P10830 | 55,90 | PB3.0-PVM10830 | 65,90 |
| PZ - Garnitur | PB3.0-10832 | 45,90 | PB3.0-P10832 | 55,90 | PB3.0-PVM10832 | 65,90 |
| OS - Garnitur (ohne Schlüsselrosette) | PB3.0-10830S | 41,90 | PB3.0-P10830S | 51,90 | PB3.0-PVM10830S | 61,90 |
| RZ - Garnitur | PB3.0-10838 | 45,90 | PB3.0-P10838 | 55,90 | PB3.0-PVM10838 | 65,90 |
| WC - Garnitur | PB3.0-10833 | 55,90 | PB3.0-P10833 | 65,90 | PB3.0-PVM10833 | 75,90 |
| WC - Garnitur rot/weiß Anz. | PB3.0-108331 | 59,90 | PB3.0-P108331 | 69,90 | PB3.0-PVM108331 | 79,90 |
| WC - Garnitur rot/grün Anz. | PB3.0-108332 | 59,90 | PB3.0-P108332 | 69,90 | PB3.0-PVM108332 | 79,90 |
| PZ-WG - Knopf ger. DIN R/L | PB3.0-10835/6 | 59,90 | PB3.0-P10835/6 | 69,90 | PB3.0-PVM10835/6 | 79,90 |
| PZ-WG - Knopf gekr. DIN R/L | PB3.0-108351/61 | 63,90 | PB3.0-P108351/61 | 73,90 | PB3.0-PVM108351/61 | 83,90 |
| Drückerpaar | | | | | | |
| ohne Rosetten | D10830 | 25,90 | DP10830 | 33,90 | DPVM10830 | 41,90 |

Standard-Türstärken: 38 - 42 mm
 Aufpreis für Türstärken ab 42 mm: € 5,00



Drücker EDELSTAHL matt
Rosette EDELSTAHL matt



Drücker EDELSTAHL poliert
Rosette EDELSTAHL poliert



Drücker PVD Messinggelb
Rosette PVD Messinggelb

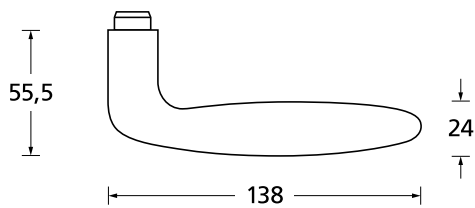



Pullbloc® 3.0 Kugellagertechnik

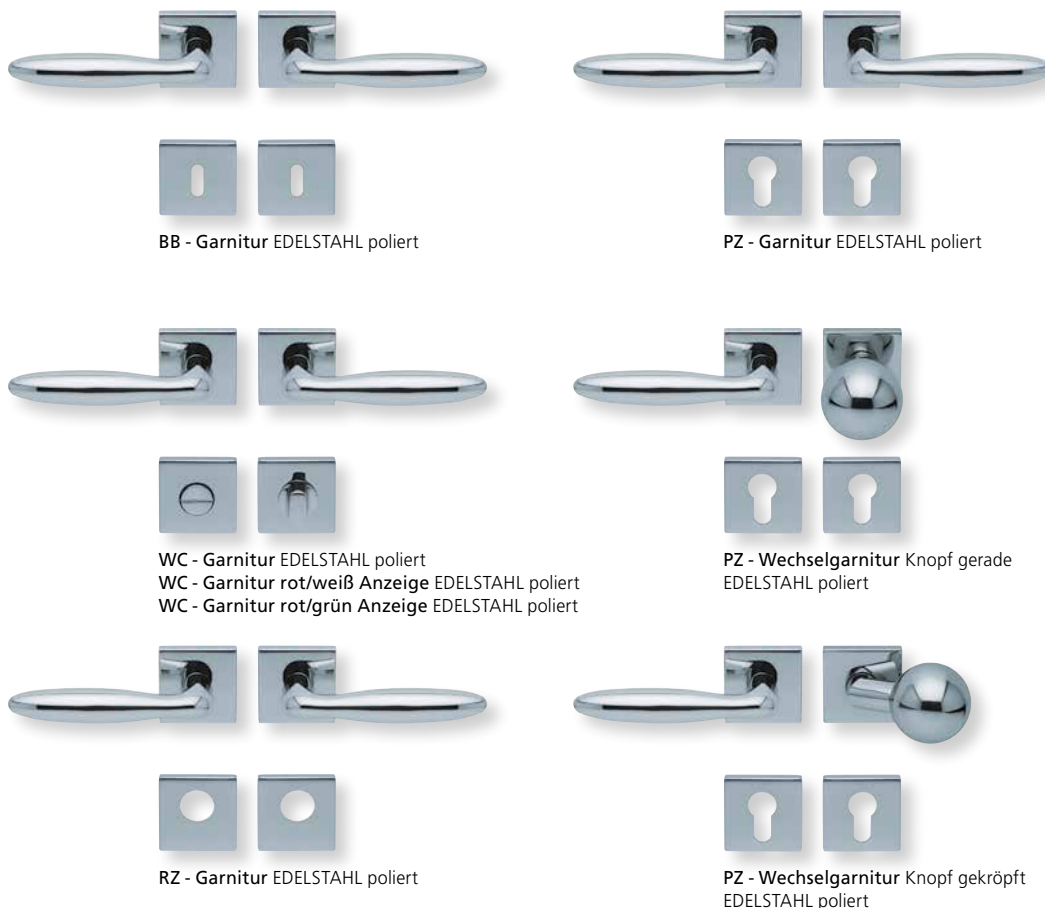

Form 1083 auf Quadratrosette

| | Edelstahl matt | | Edelstahl poliert | | PVD Messinggelb | |
|---------------------------------------|------------------|-------|-------------------|-------|---------------------|-------|
| | € exkl. MwSt. | | € exkl. MwSt. | | € exkl. MwSt. | |
| Rosettengarnitur | | | | | | |
| BB - Garnitur | PB3.0-Q10830 | 51,90 | PB3.0-QP10830 | 61,90 | PB3.0-QPVM10830 | 71,90 |
| PZ - Garnitur | PB3.0-Q10832 | 51,90 | PB3.0-QP10832 | 61,90 | PB3.0-QPVM10832 | 71,90 |
| OS - Garnitur (ohne Schlüsselrosette) | PB3.0-Q10830S | 47,90 | PB3.0-QP10830S | 57,90 | PB3.0-QPVM10830S | 67,90 |
| RZ - Garnitur | PB3.0-Q10838 | 51,90 | PB3.0-QP10838 | 61,90 | PB3.0-QPVM10838 | 71,90 |
| WC - Garnitur | PB3.0-Q10833 | 61,90 | PB3.0-QP10833 | 71,90 | PB3.0-QPVM10833 | 81,90 |
| WC - Garnitur rot/weiß Anz. | PB3.0-Q108331 | 65,90 | PB3.0-QP108331 | 75,90 | PB3.0-QPVM108331 | 85,90 |
| WC - Garnitur rot/grün Anz. | PB3.0-Q108332 | 65,90 | PB3.0-QP108332 | 75,90 | PB3.0-QPVM108332 | 85,90 |
| PZ-WG - Knopf ger. DIN R/L | PB3.0-Q10835/6 | 65,90 | PB3.0-QP10835/6 | 75,90 | PB3.0-QPVM10835/6 | 85,90 |
| PZ-WG - Knopf gekr. DIN R/L | PB3.0-Q108351/61 | 69,90 | PB3.0-QP108351/61 | 79,90 | PB3.0-QPVM108351/61 | 89,90 |
| Drückerpaar | | | | | | |
| ohne Rosetten | D10830 | 25,90 | DP10830 | 33,90 | DPVM10830 | 41,90 |

Standard-Türstärken: 38 - 42 mm
 Aufpreis für Türstärken ab 42 mm: € 5,00



Drücker EDELSTAHL matt
Rosette EDELSTAHL matt



Drücker EDELSTAHL poliert
Rosette EDELSTAHL poliert



Drücker PVD Messinggelb
Rosette PVD Messinggelb

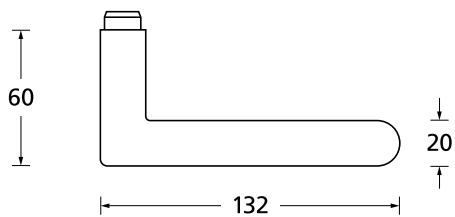



Pullbloc® 3.0 Kugellagertechnik



BB - Garnitur EDELSTAHL matt



PZ - Garnitur EDELSTAHL matt



WC - Garnitur EDELSTAHL matt
WC - Garnitur rot/weiß Anzeige EDELSTAHL matt
WC - Garnitur rot/grün Anzeige EDELSTAHL matt



PZ - Wechselgarnitur Knopf gerade EDELSTAHL matt



RZ - Garnitur EDELSTAHL matt



PZ - Wechselgarnitur Knopf gekröpft EDELSTAHL matt

Form 1084 auf Rundrosette

| | Edelstahl matt | | Edelstahl poliert | | PVD Messinggelb | |
|---------------------------------------|-----------------|---------------|-------------------|---------------|--------------------|---------------|
| | | € exkl. MwSt. | | € exkl. MwSt. | | € exkl. MwSt. |
| Rosettengarnitur | | | | | | |
| BB - Garnitur | PB3.0-10840 | 39,90 | PB3.0-P10840 | 49,90 | PB3.0-PVM10840 | 59,90 |
| PZ - Garnitur | PB3.0-10842 | 39,90 | PB3.0-P10842 | 49,90 | PB3.0-PVM10842 | 59,90 |
| OS - Garnitur (ohne Schlüsselrosette) | PB3.0-10840S | 35,90 | PB3.0-P10840S | 45,90 | PB3.0-PVM10840S | 55,90 |
| RZ - Garnitur | PB3.0-10848 | 39,90 | PB3.0-P10848 | 49,90 | PB3.0-PVM10848 | 59,90 |
| WC - Garnitur | PB3.0-10843 | 49,90 | PB3.0-P10843 | 59,90 | PB3.0-PVM10843 | 69,90 |
| WC - Garnitur rot/weiß Anz. | PB3.0-108431 | 53,90 | PB3.0-P108431 | 63,90 | PB3.0-PVM108431 | 73,90 |
| WC - Garnitur rot/grün Anz. | PB3.0-108432 | 53,90 | PB3.0-P108432 | 63,90 | PB3.0-PVM108432 | 73,90 |
| PZ-WG - Knopf ger. DIN R/L | PB3.0-10845/6 | 53,90 | PB3.0-P10845/6 | 63,90 | PB3.0-PVM10845/6 | 73,90 |
| PZ-WG - Knopf gekr. DIN R/L | PB3.0-108451/61 | 57,90 | PB3.0-P108451/61 | 67,90 | PB3.0-PVM108451/61 | 77,90 |
| Drückerpaar | | | | | | |
| ohne Rosetten | D10840 | 19,90 | DP10840 | 27,90 | DPVM10840 | 35,90 |

Standard-Türstärken: 38 - 42 mm
Aufpreis für Türstärken ab 42 mm: € 5,00



Drücker EDELSTAHL matt
Rosette EDELSTAHL matt



Drücker EDELSTAHL poliert
Rosette EDELSTAHL poliert

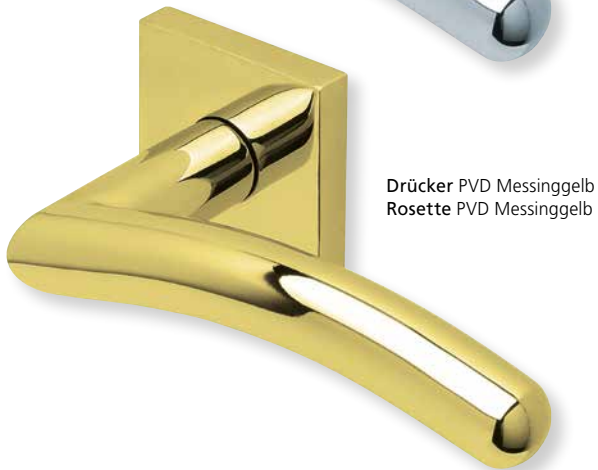

Drücker PVD Messinggelb
Rosette PVD Messinggelb

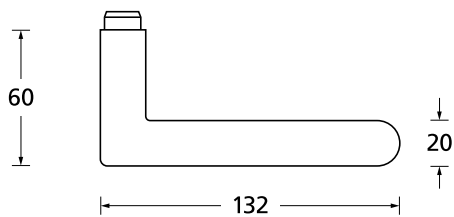



Pullbloc® 3.0 Kugellagertechnik



BB - Garnitur EDELSTAHL poliert



PZ - Garnitur EDELSTAHL poliert



WC - Garnitur EDELSTAHL poliert
WC - Garnitur rot/weiß Anzeige EDELSTAHL poliert
WC - Garnitur rot/grün Anzeige EDELSTAHL poliert



PZ - Wechselgarnitur Knopf gerade EDELSTAHL poliert



RZ - Garnitur EDELSTAHL poliert



PZ - Wechselgarnitur Knopf gekröpft EDELSTAHL poliert

Form 1084 auf Quadratrosette

| | Edelstahl matt | | Edelstahl poliert | | PVD Messinggelb | |
|---------------------------------------|------------------|---------------|-------------------|---------------|---------------------|---------------|
| | | € exkl. MwSt. | | € exkl. MwSt. | | € exkl. MwSt. |
| Rosettengarnitur | | | | | | |
| BB - Garnitur | PB3.0-Q10840 | 45,90 | PB3.0-QP10840 | 55,90 | PB3.0-QPVM10840 | 65,90 |
| PZ - Garnitur | PB3.0-Q10842 | 45,90 | PB3.0-QP10842 | 55,90 | PB3.0-QPVM10842 | 65,90 |
| OS - Garnitur (ohne Schlüsselrosette) | PB3.0-Q10840S | 41,90 | PB3.0-QP10840S | 51,90 | PB3.0-QPVM10840S | 61,90 |
| RZ - Garnitur | PB3.0-Q10848 | 45,90 | PB3.0-QP10848 | 55,90 | PB3.0-QPVM10848 | 65,90 |
| WC - Garnitur | PB3.0-Q10843 | 55,90 | PB3.0-QP10843 | 65,90 | PB3.0-QPVM10843 | 75,90 |
| WC - Garnitur rot/weiß Anz. | PB3.0-Q108431 | 59,90 | PB3.0-QP108431 | 69,90 | PB3.0-QPVM108431 | 79,90 |
| WC - Garnitur rot/grün Anz. | PB3.0-Q108432 | 59,90 | PB3.0-QP108432 | 69,90 | PB3.0-QPVM108432 | 79,90 |
| PZ-WG - Knopf ger. DIN R/L | PB3.0-Q10845/6 | 59,90 | PB3.0-QP10845/6 | 69,90 | PB3.0-QPVM10845/6 | 79,90 |
| PZ-WG - Knopf gekr. DIN R/L | PB3.0-Q108451/61 | 63,90 | PB3.0-QP108451/61 | 73,90 | PB3.0-QPVM108451/61 | 83,90 |
| Drückerpaar | | | | | | |
| ohne Rosetten | D10840 | 19,90 | DP10840 | 27,90 | DPVM10840 | 35,90 |

Standard-Türstärken: 38 - 42 mm
Aufpreis für Türstärken ab 42 mm: € 5,00



Drücker EDELSTAHL matt
Rosette EDELSTAHL matt



Drücker EDELSTAHL poliert
Rosette EDELSTAHL poliert



Drücker PVD Messinggelb
Rosette PVD Messinggelb

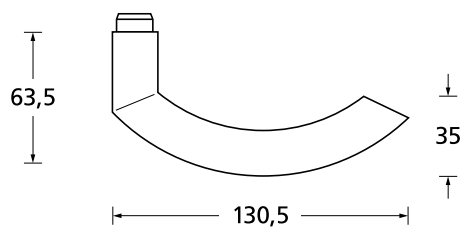



Pullbloc® 3.0 Kugellagertechnik



BB - Garnitur EDELSTAHL matt



PZ - Garnitur EDELSTAHL matt



WC - Garnitur EDELSTAHL matt
WC - Garnitur rot/weiß Anzeige EDELSTAHL matt
WC - Garnitur rot/grün Anzeige EDELSTAHL matt



PZ - Wechselgarnitur Knopf gerade
EDELSTAHL matt



RZ - Garnitur EDELSTAHL matt



PZ - Wechselgarnitur Knopf gekröpft
EDELSTAHL matt

Form 1085 auf Rundrosette

| | Edelstahl matt | | Edelstahl poliert | | PVD Messinggelb | |
|---------------------------------------|-----------------|---------------|-------------------|---------------|--------------------|---------------|
| | | € exkl. MwSt. | | € exkl. MwSt. | | € exkl. MwSt. |
| Rosettengarnitur | | | | | | |
| BB - Garnitur | PB3.0-10850 | 39,90 | PB3.0-P10850 | 49,90 | PB3.0-PVM10850 | 59,90 |
| PZ - Garnitur | PB3.0-10852 | 39,90 | PB3.0-P10852 | 49,90 | PB3.0-PVM10852 | 59,90 |
| OS - Garnitur (ohne Schlüsselrosette) | PB3.0-10850S | 35,90 | PB3.0-P10850S | 45,90 | PB3.0-PVM10850S | 55,90 |
| RZ - Garnitur | PB3.0-10858 | 39,90 | PB3.0-P10858 | 49,90 | PB3.0-PVM10858 | 59,90 |
| WC - Garnitur | PB3.0-10853 | 49,90 | PB3.0-P10853 | 59,90 | PB3.0-PVM10853 | 69,90 |
| WC - Garnitur rot/weiß Anz. | PB3.0-108531 | 53,90 | PB3.0-P108531 | 63,90 | PB3.0-PVM108531 | 73,90 |
| WC - Garnitur rot/grün Anz. | PB3.0-108532 | 53,90 | PB3.0-P108532 | 63,90 | PB3.0-PVM108532 | 73,90 |
| PZ-WG - Knopf ger. DIN R/L | PB3.0-10855/6 | 53,90 | PB3.0-P10855/6 | 63,90 | PB3.0-PVM10855/6 | 73,90 |
| PZ-WG - Knopf gekr. DIN R/L | PB3.0-108551/61 | 57,90 | PB3.0-P108551/61 | 67,90 | PB3.0-PVM108551/61 | 77,90 |
| Drückerpaar | | | | | | |
| ohne Rosetten | D10850 | 19,90 | DP10850 | 27,90 | DPVM10850 | 35,90 |

Standard-Türstärken: 38 - 42 mm
Aufpreis für Türstärken ab 42 mm: € 5,00



Drücker EDELSTAHL matt
Rosette EDELSTAHL matt



Drücker EDELSTAHL poliert
Rosette EDELSTAHL poliert



Drücker PVD Messinggelb
Rosette PVD Messinggelb

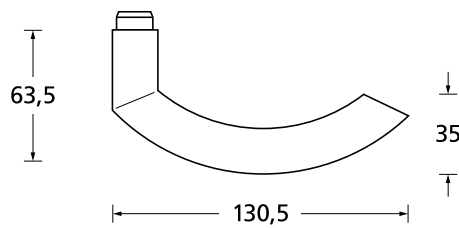



Pullbloc® 3.0 Kugellagertechnik



BB - Garnitur EDELSTAHL poliert



PZ - Garnitur EDELSTAHL poliert



WC - Garnitur EDELSTAHL poliert
WC - Garnitur rot/weiß Anzeige EDELSTAHL poliert
WC - Garnitur rot/grün Anzeige EDELSTAHL poliert



PZ - Wechselgarnitur Knopf gerade EDELSTAHL poliert



RZ - Garnitur EDELSTAHL poliert



PZ - Wechselgarnitur Knopf gekröpft EDELSTAHL poliert

Form 1085 auf Quadratrosette

| | Edelstahl matt | | Edelstahl poliert | | PVD Messinggelb | |
|---------------------------------------|------------------|-------|-------------------|-------|---------------------|-------|
| | € exkl. MwSt. | | € exkl. MwSt. | | € exkl. MwSt. | |
| Rosettengarnitur | | | | | | |
| BB - Garnitur | PB3.0-Q10850 | 45,90 | PB3.0-QP10850 | 55,90 | PB3.0-QPVM10850 | 65,90 |
| PZ - Garnitur | PB3.0-Q10852 | 45,90 | PB3.0-QP10852 | 55,90 | PB3.0-QPVM10852 | 65,90 |
| OS - Garnitur (ohne Schlüsselrosette) | PB3.0-Q10850S | 41,90 | PB3.0-QP10850S | 51,90 | PB3.0-QPVM10850S | 61,90 |
| RZ - Garnitur | PB3.0-Q10858 | 45,90 | PB3.0-QP10858 | 55,90 | PB3.0-QPVM10858 | 65,90 |
| WC - Garnitur | PB3.0-Q10853 | 55,90 | PB3.0-QP10853 | 65,90 | PB3.0-QPVM10853 | 75,90 |
| WC - Garnitur rot/weiß Anz. | PB3.0-Q108531 | 59,90 | PB3.0-QP108531 | 69,90 | PB3.0-QPVM108531 | 79,90 |
| WC - Garnitur rot/grün Anz. | PB3.0-Q108532 | 59,90 | PB3.0-QP108532 | 69,90 | PB3.0-QPVM108532 | 79,90 |
| PZ-WG - Knopf ger. DIN R/L | PB3.0-Q10855/6 | 59,90 | PB3.0-QP10855/6 | 69,90 | PB3.0-QPVM10855/6 | 79,90 |
| PZ-WG - Knopf gekr. DIN R/L | PB3.0-Q108551/61 | 63,90 | PB3.0-QP108551/61 | 73,90 | PB3.0-QPVM108551/61 | 83,90 |
| Drückerpaar | | | | | | |
| ohne Rosetten | D10850 | 19,90 | DP10850 | 27,90 | DPVM10850 | 35,90 |

Standard-Türstärken: 38 - 42 mm
Aufpreis für Türstärken ab 42 mm: € 5,00



Drücker EDELSTAHL matt
Rosette EDELSTAHL matt



Drücker EDELSTAHL poliert
Rosette EDELSTAHL poliert

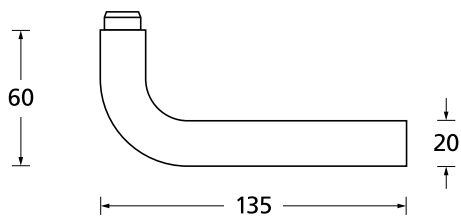



Pullbloc® 3.0 Kugellagertechnik

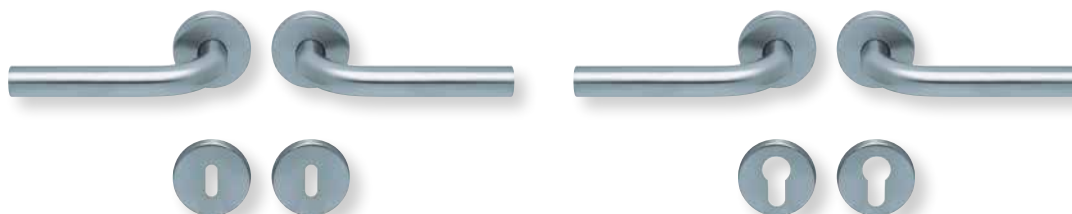

BB - Garnitur EDELSTAHL matt

PZ - Garnitur EDELSTAHL matt

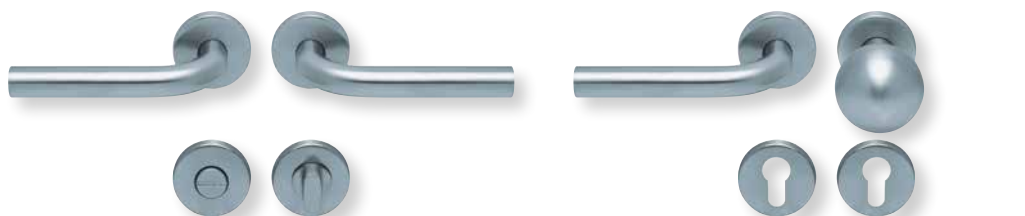

WC - Garnitur EDELSTAHL matt
WC - Garnitur rot/weiß Anzeige EDELSTAHL matt
WC - Garnitur rot/grün Anzeige EDELSTAHL matt

PZ - Wechselgarnitur Knopf gerade EDELSTAHL matt

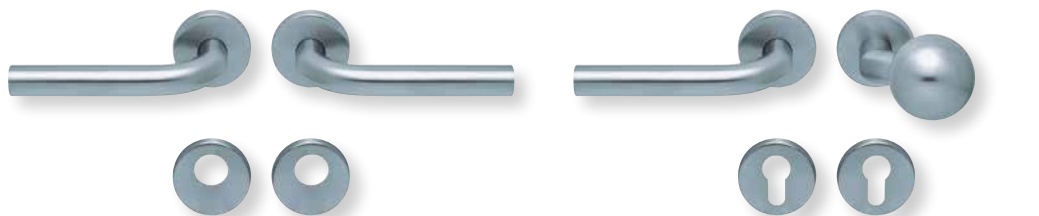

RZ - Garnitur EDELSTAHL matt

PZ - Wechselgarnitur Knopf gekröpft EDELSTAHL matt

Form 1100 auf Rundrosette

| | Edelstahl matt | | Edelstahl poliert | |
|---------------------------------------|-----------------|---------------|-------------------|---------------|
| | | € exkl. MwSt. | | € exkl. MwSt. |
| Rosettengarnitur | | | | |
| BB - Garnitur | PB3.0-11000 | 39,90 | PB3.0-P11000 | 49,90 |
| PZ - Garnitur | PB3.0-11002 | 39,90 | PB3.0-P11002 | 49,90 |
| OS - Garnitur (ohne Schlüsselrosette) | PB3.0-1100OS | 35,90 | PB3.0-P1100OS | 45,90 |
| RZ - Garnitur | PB3.0-11008 | 39,90 | PB3.0-P11008 | 49,90 |
| WC - Garnitur | PB3.0-11003 | 49,90 | PB3.0-P11003 | 59,90 |
| WC - Garnitur rot/weiß Anz. | PB3.0-110031 | 53,90 | PB3.0-P110031 | 63,90 |
| WC - Garnitur rot/grün Anz. | PB3.0-110032 | 53,90 | PB3.0-P110032 | 63,90 |
| PZ-WG - Knopf ger. DIN R/L | PB3.0-11005/6 | 53,90 | PB3.0-P11005/6 | 63,90 |
| PZ-WG - Knopf gekr. DIN R/L | PB3.0-110051/61 | 57,90 | PB3.0-P110051/61 | 67,90 |
| Drückerpaar | | | | |
| ohne Rosetten | D11001 | 19,90 | DP11001 | 27,90 |

Standard-Türstärken: 38 - 42 mm
Aufpreis für Türstärken ab 42 mm: € 5,00



Drücker EDELSTAHL matt
Rosette EDELSTAHL matt



Drücker EDELSTAHL poliert
Rosette EDELSTAHL poliert

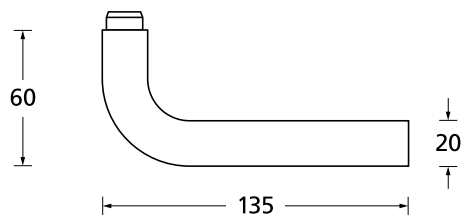



Pullbloc® 3.0 Kugellagertechnik

137



BB - Garnitur EDELSTAHL poliert



PZ - Garnitur EDELSTAHL poliert



WC - Garnitur EDELSTAHL poliert
WC - Garnitur rot/weiß Anzeige EDELSTAHL poliert
WC - Garnitur rot/grün Anzeige EDELSTAHL poliert



PZ - Wechselgarnitur Knopf gerade
EDELSTAHL poliert



RZ - Garnitur EDELSTAHL poliert



PZ - Wechselgarnitur Knopf gekröpft
EDELSTAHL poliert

Form 1100 auf Quadratrosette

| Rosettengarnitur | Edelstahl matt | | Edelstahl poliert | |
|---------------------------------------|------------------|---------------|-------------------|---------------|
| | | € exkl. MwSt. | | € exkl. MwSt. |
| BB - Garnitur | PB3.0-Q11000 | 45,90 | PB3.0-QP11000 | 55,90 |
| PZ - Garnitur | PB3.0-Q11002 | 45,90 | PB3.0-QP11002 | 55,90 |
| OS - Garnitur (ohne Schlüsselrosette) | PB3.0-Q11000S | 41,90 | PB3.0-QP11000S | 51,90 |
| RZ - Garnitur | PB3.0-Q11008 | 45,90 | PB3.0-QP11008 | 55,90 |
| WC - Garnitur | PB3.0-Q11003 | 55,90 | PB3.0-QP11003 | 65,90 |
| WC - Garnitur rot/weiß Anz. | PB3.0-Q110031 | 59,90 | PB3.0-QP110031 | 69,90 |
| WC - Garnitur rot/grün Anz. | PB3.0-Q110032 | 59,90 | PB3.0-QP110032 | 69,90 |
| PZ-WG - Knopf ger. DIN R/L | PB3.0-Q11005/6 | 59,90 | PB3.0-QP11005/6 | 69,90 |
| PZ-WG - Knopf gekr. DIN R/L | PB3.0-Q110051/61 | 63,90 | PB3.0-QP110051/61 | 73,90 |
| Drückerpaar | | | | |
| ohne Rosetten | D11001 | 19,90 | DP11001 | 27,90 |

Standard-Türstärken: 38 - 42 mm
Aufpreis für Türstärken ab 42 mm: € 5,00



Drücker EDELSTAHL poliert/EDELSTAHL matt
Rosette EDELSTAHL matt



Drücker EDELSTAHL poliert/EDELSTAHL matt
Rosette EDELSTAHL poliert

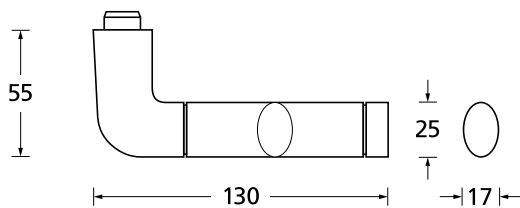



Pullbloc® 3.0 Kugellagertechnik



BB - Garnitur EDELSTAHL poliert



PZ - Garnitur EDELSTAHL poliert



WC - Garnitur EDELSTAHL poliert
WC - Garnitur rot/weiß Anzeige EDELSTAHL poliert
WC - Garnitur rot/grün Anzeige EDELSTAHL poliert



PZ - Wechselgarnitur Knopf gerade EDELSTAHL poliert



RZ - Garnitur EDELSTAHL poliert



PZ - Wechselgarnitur Knopf gekröpft EDELSTAHL poliert

Form 1101 auf Rundrosette

| | Edelstahl matt | | Edelstahl poliert | |
|---------------------------------------|-----------------|---------------|-------------------|---------------|
| | | € exkl. MwSt. | | € exkl. MwSt. |
| Rosettengarnitur | | | | |
| BB - Garnitur | PB3.0-11010 | 45,90 | PB3.0-P11010 | 51,90 |
| PZ - Garnitur | PB3.0-11012 | 45,90 | PB3.0-P11012 | 51,90 |
| OS - Garnitur (ohne Schlüsselrosette) | PB3.0-1101OS | 41,90 | PB3.0-P1101OS | 47,90 |
| RZ - Garnitur | PB3.0-11018 | 45,90 | PB3.0-P11018 | 51,90 |
| WC - Garnitur | PB3.0-11013 | 55,90 | PB3.0-P11013 | 61,90 |
| WC - Garnitur rot/weiß Anz. | PB3.0-110131 | 59,90 | PB3.0-P110131 | 65,90 |
| WC - Garnitur rot/grün Anz. | PB3.0-110132 | 59,90 | PB3.0-P110132 | 65,90 |
| PZ-WG - Knopf ger. DIN R/L | PB3.0-11015/6 | 59,90 | PB3.0-P11015/6 | 65,90 |
| PZ-WG - Knopf gekr. DIN R/L | PB3.0-110151/61 | 63,90 | PB3.0-P110151/61 | 69,90 |
| Drückerpaar | | | | |
| ohne Rosetten | D11010 | 25,90 | D11010 | 25,90 |

Standard-Türstärken: 38 - 42 mm
Aufpreis für Türstärken ab 42 mm: € 5,00

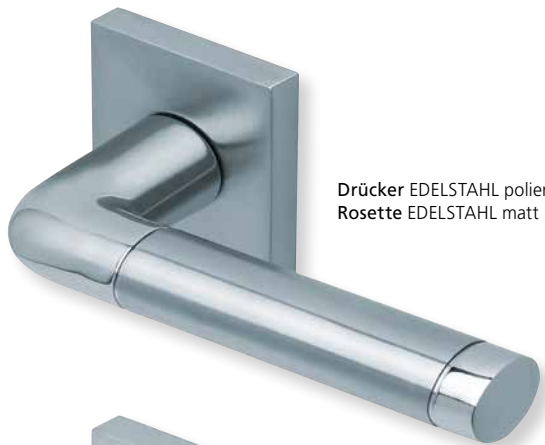

Drücker EDELSTAHL poliert/EDELSTAHL matt
Rosette EDELSTAHL matt

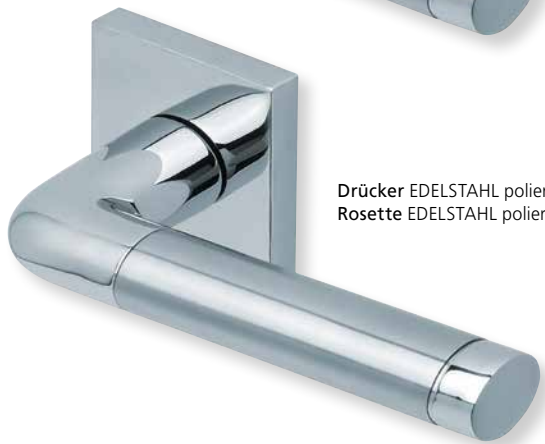

Drücker EDELSTAHL poliert/EDELSTAHL matt
Rosette EDELSTAHL poliert

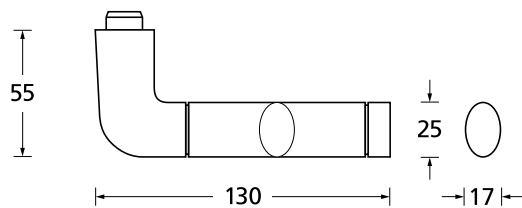



Pullbloc® 3.0 Kugellagertechnik

141



BB - Garnitur EDELSTAHL poliert



PZ - Garnitur EDELSTAHL poliert



WC - Garnitur EDELSTAHL poliert
WC - Garnitur rot/weiß Anzeige EDELSTAHL poliert
WC - Garnitur rot/grün Anzeige EDELSTAHL poliert



PZ - Wechselgarnitur Knopf gerade
EDELSTAHL poliert



RZ - Garnitur EDELSTAHL poliert



PZ - Wechselgarnitur Knopf gekröpft
EDELSTAHL poliert

Form 1101 auf Quadratrosette

| Rosettengarnitur | Edelstahl matt | | Edelstahl poliert | |
|---------------------------------------|------------------|---------------|-------------------|---------------|
| | | € exkl. MwSt. | | € exkl. MwSt. |
| BB - Garnitur | PB3.0-Q11010 | 51,90 | PB3.0-QP11010 | 57,90 |
| PZ - Garnitur | PB3.0-Q11012 | 51,90 | PB3.0-QP11012 | 57,90 |
| OS - Garnitur (ohne Schlüsselrosette) | PB3.0-Q11010S | 47,90 | PB3.0-QP11010S | 53,90 |
| RZ - Garnitur | PB3.0-Q11018 | 51,90 | PB3.0-QP11018 | 57,90 |
| WC - Garnitur | PB3.0-Q11013 | 61,90 | PB3.0-QP11013 | 67,90 |
| WC - Garnitur rot/weiß Anz. | PB3.0-Q110131 | 65,90 | PB3.0-QP110131 | 71,90 |
| WC - Garnitur rot/grün Anz. | PB3.0-Q110132 | 65,90 | PB3.0-QP110132 | 71,90 |
| PZ-WG - Knopf ger. DIN R/L | PB3.0-Q11015/6 | 65,90 | PB3.0-QP11015/6 | 71,90 |
| PZ-WG - Knopf gekr. DIN R/L | PB3.0-Q110151/61 | 69,90 | PB3.0-QP110151/61 | 75,90 |
| Drückerpaar | | | | |
| ohne Rosetten | D11010 | 25,90 | D11010 | 25,90 |

Standard-Türstärken: 38 - 42 mm
Aufpreis für Türstärken ab 42 mm: € 5,00



Drücker EDELSTAHL matt
Rosette EDELSTAHL matt



Drücker EDELSTAHL poliert
Rosette EDELSTAHL poliert



Drücker PVD Messinggelb
Rosette PVD Messinggelb

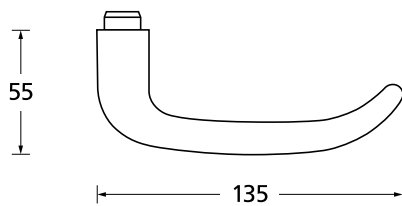



Pullbloc® 3.0 Kugellagertechnik



BB - Garnitur EDELSTAHL matt



PZ - Garnitur EDELSTAHL matt



WC - Garnitur EDELSTAHL matt
WC - Garnitur rot/weiß Anzeige EDELSTAHL matt
WC - Garnitur rot/grün Anzeige EDELSTAHL matt



PZ - Wechselgarnitur Knopf gerade
EDELSTAHL matt



RZ - Garnitur EDELSTAHL matt



PZ - Wechselgarnitur Knopf gekröpft
EDELSTAHL matt

Form 1103 auf Rundrosette

| | Edelstahl matt | | Edelstahl poliert | | PVD Messinggelb | |
|---------------------------------------|-----------------|-------|-------------------|-------|--------------------|-------|
| | € exkl. MwSt. | | € exkl. MwSt. | | € exkl. MwSt. | |
| Rosettengarnitur | | | | | | |
| BB - Garnitur | PB3.0-11030 | 45,90 | PB3.0-P11030 | 55,90 | PB3.0-PVM11030 | 65,90 |
| PZ - Garnitur | PB3.0-11032 | 45,90 | PB3.0-P11032 | 55,90 | PB3.0-PVM11032 | 65,90 |
| OS - Garnitur (ohne Schlüsselrosette) | PB3.0-1103OS | 41,90 | PB3.0-P1103OS | 51,90 | PB3.0-PVM1103OS | 61,90 |
| RZ - Garnitur | PB3.0-11038 | 45,90 | PB3.0-P11038 | 55,90 | PB3.0-PVM11038 | 65,90 |
| WC - Garnitur | PB3.0-11033 | 55,90 | PB3.0-P11033 | 65,90 | PB3.0-PVM11033 | 75,90 |
| WC - Garnitur rot/weiß Anz. | PB3.0-110331 | 59,90 | PB3.0-P110331 | 69,90 | PB3.0-PVM110331 | 79,90 |
| WC - Garnitur rot/grün Anz. | PB3.0-110332 | 59,90 | PB3.0-P110332 | 69,90 | PB3.0-PVM110332 | 79,90 |
| PZ-WG - Knopf ger. DIN R/L | PB3.0-11035/6 | 59,90 | PB3.0-P11035/6 | 69,90 | PB3.0-PVM11035/6 | 79,90 |
| PZ-WG - Knopf gekr. DIN R/L | PB3.0-110351/61 | 63,90 | PB3.0-P110351/61 | 73,90 | PB3.0-PVM110351/61 | 83,90 |
| Drückerpaar | | | | | | |
| ohne Rosetten | D11030 | 25,90 | DP11030 | 33,90 | DPVM11030 | 41,90 |

Standard-Türstärken: 38 - 42 mm
Aufpreis für Türstärken ab 42 mm: € 5,00



Drücker EDELSTAHL matt
Rosette EDELSTAHL matt



Drücker EDELSTAHL poliert
Rosette EDELSTAHL poliert



Drücker PVD Messinggelb
Rosette PVD Messinggelb

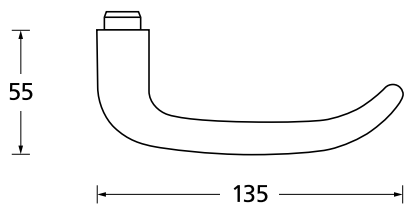



Pullbloc® 3.0 Kugellagertechnik



BB - Garnitur EDELSTAHL poliert



PZ - Garnitur EDELSTAHL poliert



WC - Garnitur EDELSTAHL poliert
WC - Garnitur rot/weiß Anzeige EDELSTAHL poliert
WC - Garnitur rot/grün Anzeige EDELSTAHL poliert



PZ - Wechselgarnitur Knopf gerade EDELSTAHL poliert



RZ - Garnitur EDELSTAHL poliert



PZ - Wechselgarnitur Knopf gekröpft EDELSTAHL poliert

Form 1103 auf Quadratrosette

| | Edelstahl matt | | Edelstahl poliert | | PVD Messinggelb | |
|---------------------------------------|------------------|-------|-------------------|-------|---------------------|-------|
| | € exkl. MwSt. | | € exkl. MwSt. | | € exkl. MwSt. | |
| Rosettengarnitur | | | | | | |
| BB - Garnitur | PB3.0-Q11030 | 51,90 | PB3.0-QP11030 | 61,90 | PB3.0-QPVM11030 | 71,90 |
| PZ - Garnitur | PB3.0-Q11032 | 51,90 | PB3.0-QP11032 | 61,90 | PB3.0-QPVM11032 | 71,90 |
| OS - Garnitur (ohne Schlüsselrosette) | PB3.0-Q1103OS | 47,90 | PB3.0-QP1103OS | 57,90 | PB3.0-QPVM1103OS | 67,90 |
| RZ - Garnitur | PB3.0-Q11038 | 51,90 | PB3.0-QP11038 | 61,90 | PB3.0-QPVM11038 | 71,90 |
| WC - Garnitur | PB3.0-Q11033 | 61,90 | PB3.0-QP11033 | 71,90 | PB3.0-QPVM11033 | 81,90 |
| WC - Garnitur rot/weiß Anz. | PB3.0-Q110331 | 65,90 | PB3.0-QP110331 | 75,90 | PB3.0-QPVM110331 | 85,90 |
| WC - Garnitur rot/grün Anz. | PB3.0-Q110332 | 65,90 | PB3.0-QP110332 | 75,90 | PB3.0-QPVM110332 | 85,90 |
| PZ-WG - Knopf ger. DIN R/L | PB3.0-Q11035/6 | 65,90 | PB3.0-QP11035/6 | 75,90 | PB3.0-QPVM11035/6 | 85,90 |
| PZ-WG - Knopf gekr. DIN R/L | PB3.0-Q110351/61 | 69,90 | PB3.0-QP110351/61 | 79,90 | PB3.0-QPVM110351/61 | 89,90 |
| Drückerpaar | | | | | | |
| ohne Rosetten | D11030 | 25,90 | DP11030 | 33,90 | DPVM11030 | 41,90 |

Standard-Türstärken: 38 - 42 mm
Aufpreis für Türstärken ab 42 mm: € 5,00



Drücker EDELSTAHL matt
Rosette EDELSTAHL matt



Drücker EDELSTAHL poliert
Rosette EDELSTAHL poliert

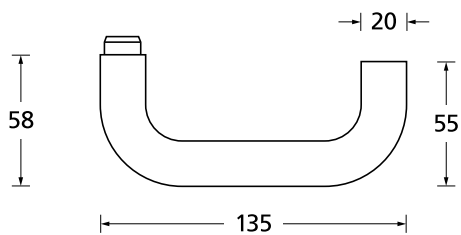



Pullbloc® 3.0 Kugellagertechnik

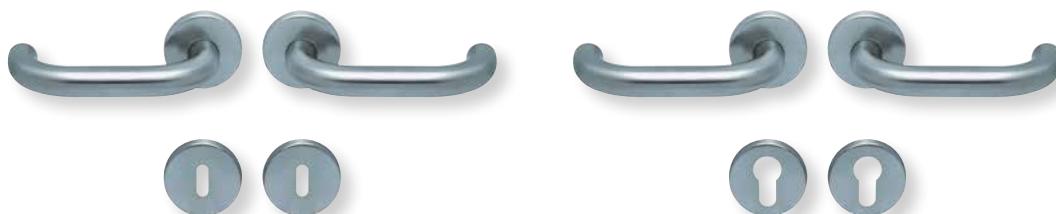

BB - Garnitur EDELSTAHL matt

PZ - Garnitur EDELSTAHL matt



WC - Garnitur EDELSTAHL matt
WC - Garnitur rot/weiß Anzeige EDELSTAHL matt
WC - Garnitur rot/grün Anzeige EDELSTAHL matt



PZ - Wechselgarnitur Knopf gerade EDELSTAHL matt



RZ - Garnitur EDELSTAHL matt



PZ - Wechselgarnitur Knopf gekröpft EDELSTAHL matt

Form 1104 auf Rundrosette

| | Edelstahl matt | | Edelstahl poliert | |
|---------------------------------------|-----------------|---------------|-------------------|---------------|
| | | € exkl. MwSt. | | € exkl. MwSt. |
| Rosettengarnitur | | | | |
| BB - Garnitur | PB3.0-11040 | 39,90 | PB3.0-P11040 | 49,90 |
| PZ - Garnitur | PB3.0-11042 | 39,90 | PB3.0-P11042 | 49,90 |
| OS - Garnitur (ohne Schlüsselrosette) | PB3.0-1104OS | 35,90 | PB3.0-P1104OS | 45,90 |
| RZ - Garnitur | PB3.0-11048 | 39,90 | PB3.0-P11048 | 49,90 |
| WC - Garnitur | PB3.0-11043 | 49,90 | PB3.0-P11043 | 59,90 |
| WC - Garnitur rot/weiß Anz. | PB3.0-110431 | 53,90 | PB3.0-P110431 | 63,90 |
| WC - Garnitur rot/grün Anz. | PB3.0-110432 | 53,90 | PB3.0-P110432 | 63,90 |
| PZ-WG - Knopf ger. DIN R/L | PB3.0-11045/6 | 53,90 | PB3.0-P11045/6 | 63,90 |
| PZ-WG - Knopf gekr. DIN R/L | PB3.0-110451/61 | 57,90 | PB3.0-P110451/61 | 67,90 |
| Drückerpaar | | | | |
| ohne Rosetten | D11040 | 19,90 | DP11040 | 27,90 |

Standard-Türstärken: 38 - 42 mm
Aufpreis für Türstärken ab 42 mm: € 5,00



Drücker EDELSTAHL matt
Rosette EDELSTAHL matt



Drücker EDELSTAHL poliert
Rosette EDELSTAHL poliert

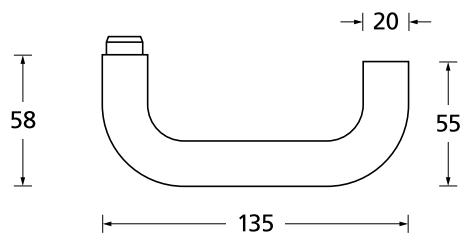



Pullbloc® 3.0 Kugellagertechnik

149



BB - Garnitur EDELSTAHL poliert



PZ - Garnitur EDELSTAHL poliert



WC - Garnitur EDELSTAHL poliert
WC - Garnitur rot/weiß Anzeige EDELSTAHL poliert
WC - Garnitur rot/grün Anzeige EDELSTAHL poliert



PZ - Wechselgarnitur Knopf gerade
EDELSTAHL poliert



RZ - Garnitur EDELSTAHL poliert



PZ - Wechselgarnitur Knopf gekröpft
EDELSTAHL poliert

Form 1104 auf Quadratrosette

| Rosettengarnitur | Edelstahl matt | | Edelstahl poliert | |
|---------------------------------------|------------------|---------------|-------------------|---------------|
| | | € exkl. MwSt. | | € exkl. MwSt. |
| BB - Garnitur | PB3.0-Q11040 | 45,90 | PB3.0-QP11040 | 55,90 |
| PZ - Garnitur | PB3.0-Q11042 | 45,90 | PB3.0-QP11042 | 55,90 |
| OS - Garnitur (ohne Schlüsselrosette) | PB3.0-Q1104OS | 41,90 | PB3.0-QP1104OS | 51,90 |
| RZ - Garnitur | PB3.0-Q11048 | 45,90 | PB3.0-QP11048 | 55,90 |
| WC - Garnitur | PB3.0-Q11043 | 55,90 | PB3.0-QP11043 | 65,90 |
| WC - Garnitur rot/weiß Anz. | PB3.0-Q110431 | 59,90 | PB3.0-QP110431 | 69,90 |
| WC - Garnitur rot/grün Anz. | PB3.0-Q110432 | 59,90 | PB3.0-QP110432 | 69,90 |
| PZ-WG - Knopf ger. DIN R/L | PB3.0-Q11045/6 | 59,90 | PB3.0-QP11045/6 | 69,90 |
| PZ-WG - Knopf gekr. DIN R/L | PB3.0-Q110451/61 | 63,90 | PB3.0-QP110451/61 | 73,90 |
| Drückerpaar | | | | |
| ohne Rosetten | D11040 | 19,90 | DP11040 | 27,90 |

Standard-Türstärken: 38 - 42 mm
Aufpreis für Türstärken ab 42 mm: € 5,00



Drücker EDELSTAHL matt
Rosette EDELSTAHL matt



Drücker EDELSTAHL poliert
Rosette EDELSTAHL poliert

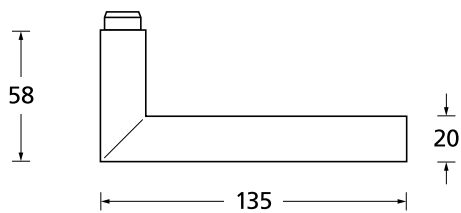



Pullbloc® 3.0 Kugellagertechnik

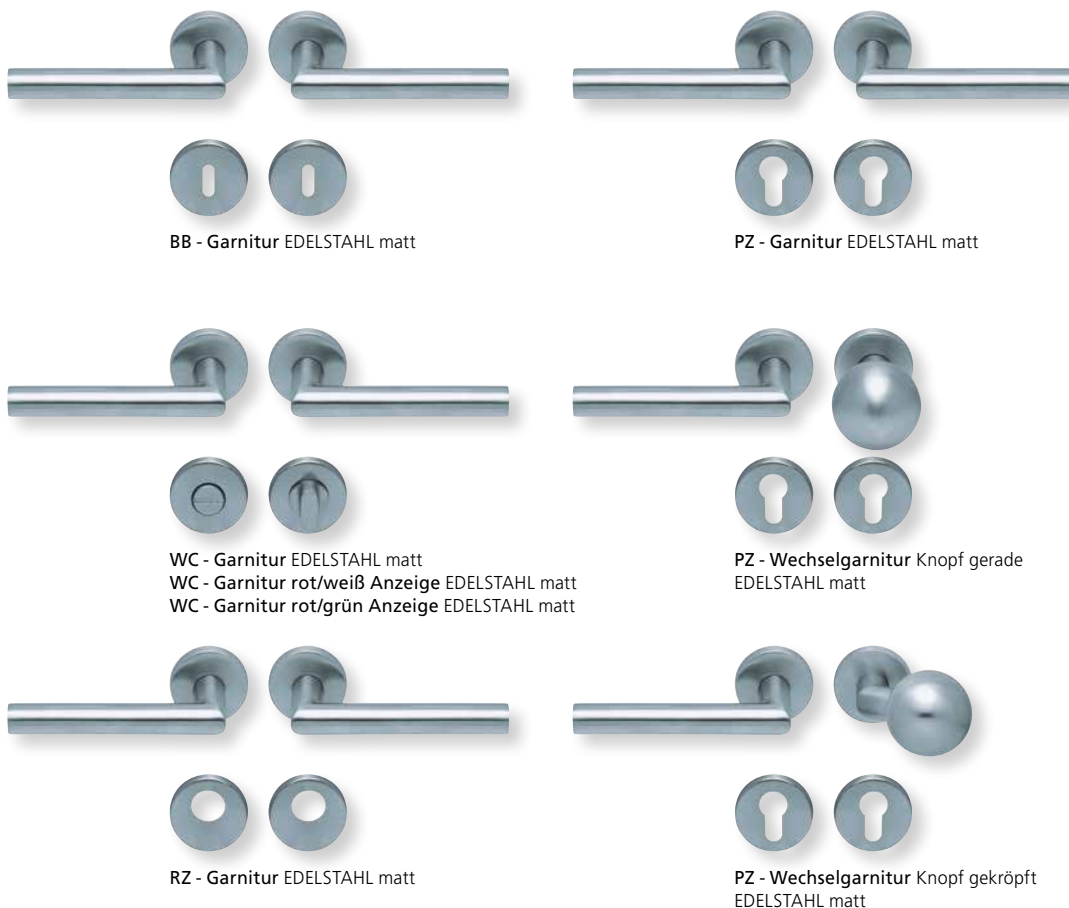

Form 1106 auf Rundrosette

| Rosettengarnitur | Edelstahl matt | | Edelstahl poliert | |
|---------------------------------------|-----------------|---------------|-------------------|---------------|
| | | € exkl. MwSt. | | € exkl. MwSt. |
| BB - Garnitur | PB3.0-11060 | 39,90 | PB3.0-P11060 | 49,90 |
| PZ - Garnitur | PB3.0-11062 | 39,90 | PB3.0-P11062 | 49,90 |
| OS - Garnitur (ohne Schlüsselrosette) | PB3.0-1106OS | 35,90 | PB3.0-P1106OS | 45,90 |
| RZ - Garnitur | PB3.0-11068 | 39,90 | PB3.0-P11068 | 49,90 |
| WC - Garnitur | PB3.0-11063 | 49,90 | PB3.0-P11063 | 59,90 |
| WC - Garnitur rot/weiß Anz. | PB3.0-110631 | 53,90 | PB3.0-P110631 | 63,90 |
| WC - Garnitur rot/grün Anz. | PB3.0-110632 | 53,90 | PB3.0-P110632 | 63,90 |
| PZ-WG - Knopf ger. DIN R/L | PB3.0-11065/6 | 53,90 | PB3.0-P11065/6 | 63,90 |
| PZ-WG - Knopf gekr. DIN R/L | PB3.0-110651/61 | 57,90 | PB3.0-P110651/61 | 67,90 |
| Drückerpaar | | | | |
| ohne Rosetten | D11060 | 19,90 | DP11060 | 27,90 |

Standard-Türstärken: 38 - 42 mm
Aufpreis für Türstärken ab 42 mm: € 5,00

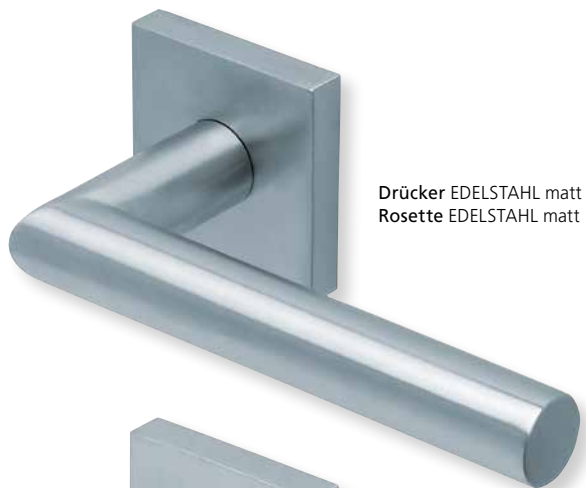

Drücker EDELSTAHL matt
Rosette EDELSTAHL matt



Drücker EDELSTAHL poliert
Rosette EDELSTAHL poliert

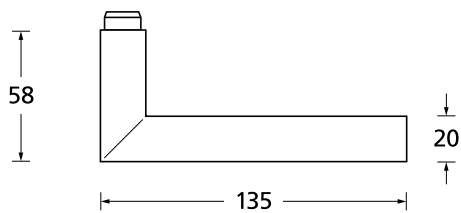



Pullbloc® 3.0 Kugellagertechnik

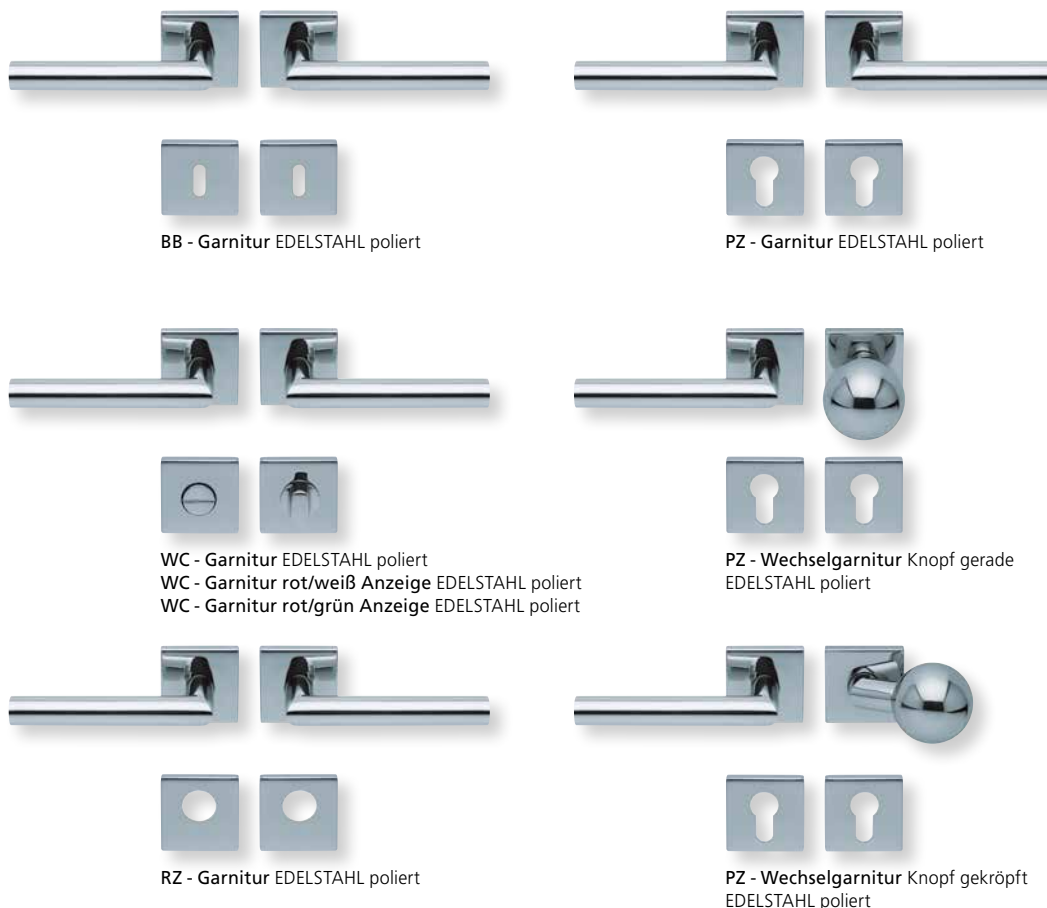

Form 1106 auf Quadratrosette

| | Edelstahl matt | | Edelstahl poliert | |
|---------------------------------------|------------------|---------------|-------------------|---------------|
| | | € exkl. MwSt. | | € exkl. MwSt. |
| Rosettengarnitur | | | | |
| BB - Garnitur | PB3.0-Q11060 | 45,90 | PB3.0-QP11060 | 55,90 |
| PZ - Garnitur | PB3.0-Q11062 | 45,90 | PB3.0-QP11062 | 55,90 |
| OS - Garnitur (ohne Schlüsselrosette) | PB3.0-Q1106OS | 41,90 | PB3.0-QP1106OS | 51,90 |
| RZ - Garnitur | PB3.0-Q11068 | 45,90 | PB3.0-QP11068 | 55,90 |
| WC - Garnitur | PB3.0-Q11063 | 55,90 | PB3.0-QP11063 | 65,90 |
| WC - Garnitur rot/weiß Anz. | PB3.0-Q110631 | 59,90 | PB3.0-QP110631 | 69,90 |
| WC - Garnitur rot/grün Anz. | PB3.0-Q110632 | 59,90 | PB3.0-QP110632 | 69,90 |
| PZ-WG - Knopf ger. DIN R/L | PB3.0-Q11065/6 | 59,90 | PB3.0-QP11065/6 | 69,90 |
| PZ-WG - Knopf gekr. DIN R/L | PB3.0-Q110651/61 | 63,90 | PB3.0-QP110651/61 | 73,90 |
| Drückerpaar | | | | |
| ohne Rosetten | D11060 | 19,90 | DP11060 | 27,90 |

Standard-Türstärken: 38 - 42 mm
 Aufpreis für Türstärken ab 42 mm: € 5,00



Drücker EDELSTAHL matt
Rosette EDELSTAHL matt



Drücker EDELSTAHL poliert
Rosette EDELSTAHL poliert

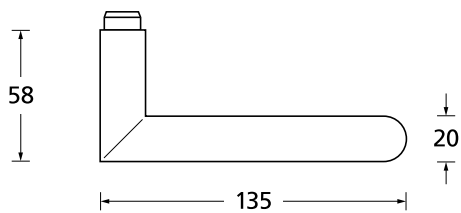



Pullbloc® 3.0 Kugellagertechnik

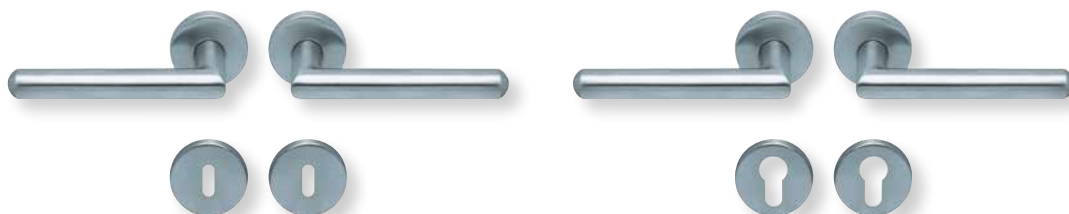

BB - Garnitur EDELSTAHL matt

PZ - Garnitur EDELSTAHL matt

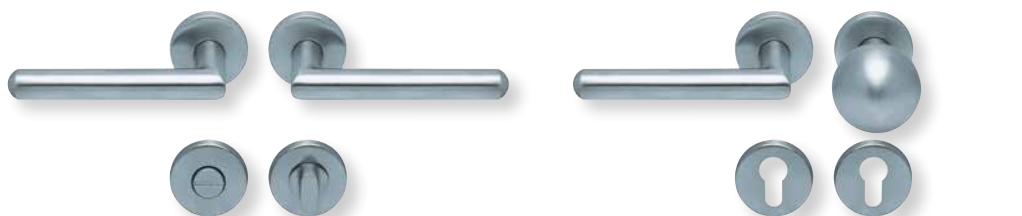

WC - Garnitur EDELSTAHL matt
 WC - Garnitur rot/weiß Anzeige EDELSTAHL matt
 WC - Garnitur rot/grün Anzeige EDELSTAHL matt

PZ - Wechselgarnitur Knopf gerade EDELSTAHL matt

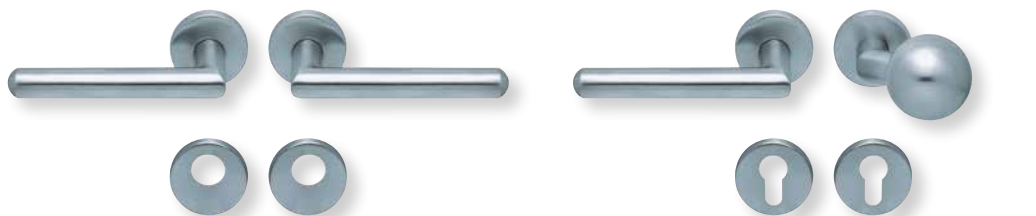

RZ - Garnitur EDELSTAHL matt

PZ - Wechselgarnitur Knopf gekröpft EDELSTAHL matt

Form 1107 auf Rundrosette

| | Edelstahl matt | | Edelstahl poliert | |
|---------------------------------------|-----------------|---------------|-------------------|---------------|
| | | € exkl. MwSt. | | € exkl. MwSt. |
| Rosettengarnitur | | | | |
| BB - Garnitur | PB3.0-11070 | 39,90 | PB3.0-P11070 | 49,90 |
| PZ - Garnitur | PB3.0-11072 | 39,90 | PB3.0-P11072 | 49,90 |
| OS - Garnitur (ohne Schlüsselrosette) | PB3.0-1107OS | 35,90 | PB3.0-P1107OS | 45,90 |
| RZ - Garnitur | PB3.0-11078 | 39,90 | PB3.0-P11078 | 49,90 |
| WC - Garnitur | PB3.0-11073 | 49,90 | PB3.0-P11073 | 59,90 |
| WC - Garnitur rot/weiß Anz. | PB3.0-110731 | 53,90 | PB3.0-P110731 | 63,90 |
| WC - Garnitur rot/grün Anz. | PB3.0-110732 | 53,90 | PB3.0-P110732 | 63,90 |
| PZ-WG - Knopf ger. DIN R/L | PB3.0-11075/6 | 53,90 | PB3.0-P11075/6 | 63,90 |
| PZ-WG - Knopf gekr. DIN R/L | PB3.0-110751/61 | 57,90 | PB3.0-P110751/61 | 67,90 |
| Drückerpaar | | | | |
| ohne Rosetten | D11070 | 19,90 | DP11070 | 27,90 |

Standard-Türstärken: 38 - 42 mm
 Aufpreis für Türstärken ab 42 mm: € 5,00

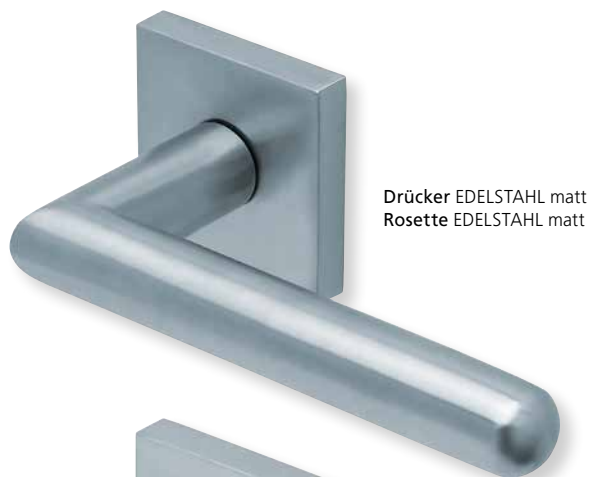

Drücker EDELSTAHL matt
Rosette EDELSTAHL matt



Drücker EDELSTAHL poliert
Rosette EDELSTAHL poliert

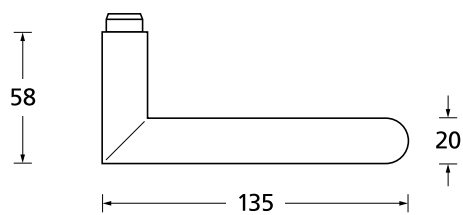



Pullbloc® 3.0 Kugellagertechnik



BB - Garnitur EDELSTAHL poliert



PZ - Garnitur EDELSTAHL poliert



WC - Garnitur EDELSTAHL poliert
WC - Garnitur rot/weiß Anzeige EDELSTAHL poliert
WC - Garnitur rot/grün Anzeige EDELSTAHL poliert



PZ - Wechselgarnitur Knopf gerade EDELSTAHL poliert



RZ - Garnitur EDELSTAHL poliert



PZ - Wechselgarnitur Knopf gekröpft EDELSTAHL poliert

Form 1107 auf Quadratrosette

| Rosettengarnitur | Edelstahl matt | | Edelstahl poliert | |
|---------------------------------------|------------------|---------------|-------------------|---------------|
| | | € exkl. MwSt. | | € exkl. MwSt. |
| BB - Garnitur | PB3.0-Q11070 | 45,90 | PB3.0-QP11070 | 55,90 |
| PZ - Garnitur | PB3.0-Q11072 | 45,90 | PB3.0-QP11072 | 55,90 |
| OS - Garnitur (ohne Schlüsselrosette) | PB3.0-Q1107OS | 41,90 | PB3.0-QP1107OS | 51,90 |
| RZ - Garnitur | PB3.0-Q11078 | 45,90 | PB3.0-QP11078 | 55,90 |
| WC - Garnitur | PB3.0-Q11073 | 55,90 | PB3.0-QP11073 | 65,90 |
| WC - Garnitur rot/weiß Anz. | PB3.0-Q110731 | 59,90 | PB3.0-QP110731 | 69,90 |
| WC - Garnitur rot/grün Anz. | PB3.0-Q110732 | 59,90 | PB3.0-QP110732 | 69,90 |
| PZ-WG - Knopf ger. DIN R/L | PB3.0-Q11075/6 | 59,90 | PB3.0-QP11075/6 | 69,90 |
| PZ-WG - Knopf gekr. DIN R/L | PB3.0-Q110751/61 | 63,90 | PB3.0-QP110751/61 | 73,90 |
| Drückerpaar | | | | |
| ohne Rosetten | D11070 | 19,90 | DP11070 | 27,90 |

Standard-Türstärken: 38 - 42 mm
Aufpreis für Türstärken ab 42 mm: € 5,00



Drücker EDELSTAHL matt
Rosette EDELSTAHL matt



Drücker EDELSTAHL poliert
Rosette EDELSTAHL poliert

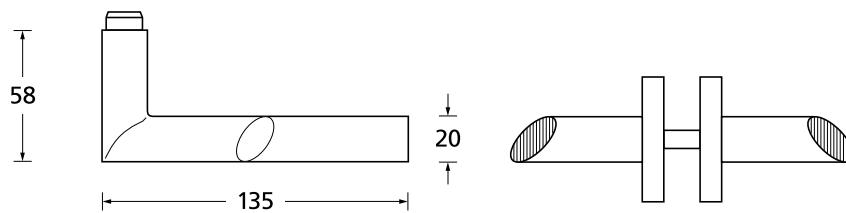



Pullbloc® 3.0 Kugellagertechnik

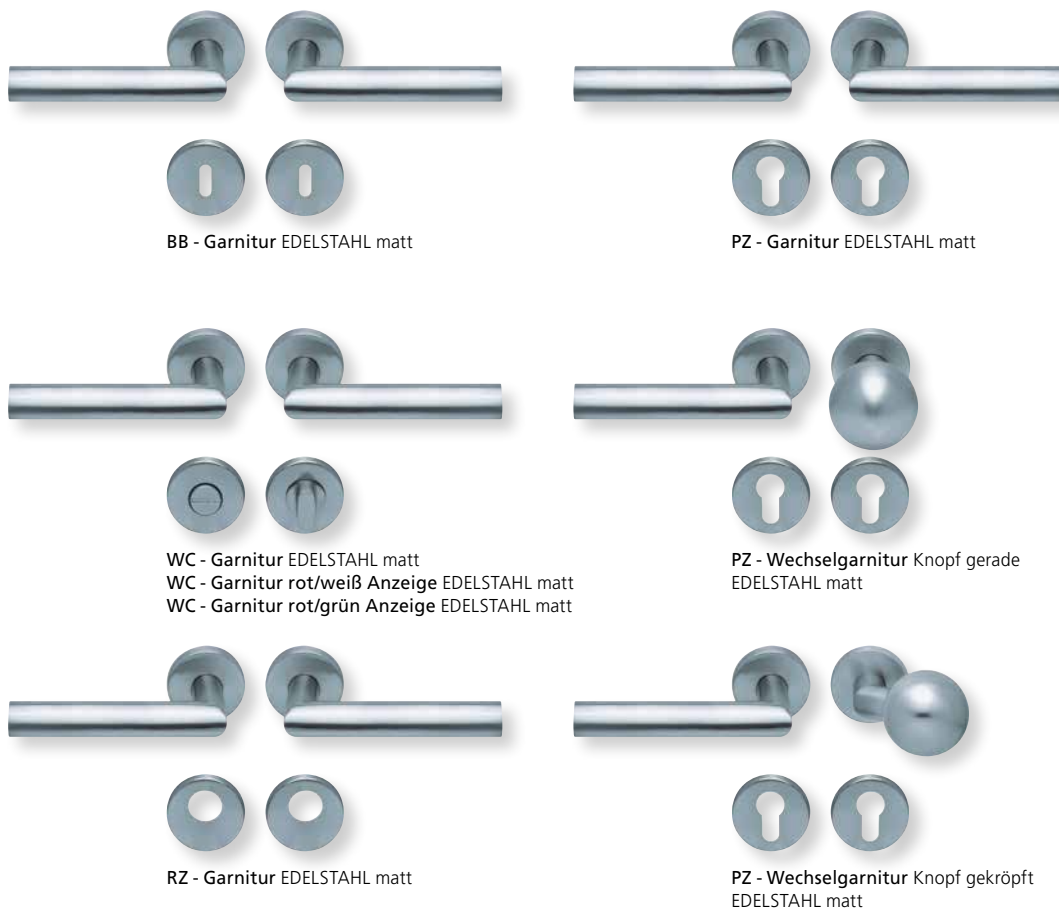

Form 1108 auf Rundrosette

| | Edelstahl matt | | Edelstahl poliert | |
|---------------------------------------|-----------------|---------------|-------------------|---------------|
| | | € exkl. MwSt. | | € exkl. MwSt. |
| Rosettengarnitur | | | | |
| BB - Garnitur | PB3.0-11080 | 39,90 | PB3.0-P11080 | 49,90 |
| PZ - Garnitur | PB3.0-11082 | 39,90 | PB3.0-P11082 | 49,90 |
| OS - Garnitur (ohne Schlüsselrosette) | PB3.0-1108OS | 35,90 | PB3.0-P1108OS | 45,90 |
| RZ - Garnitur | PB3.0-11088 | 39,90 | PB3.0-P11088 | 49,90 |
| WC - Garnitur | PB3.0-11083 | 49,90 | PB3.0-P11083 | 59,90 |
| WC - Garnitur rot/weiß Anz. | PB3.0-110831 | 53,90 | PB3.0-P110831 | 63,90 |
| WC - Garnitur rot/grün Anz. | PB3.0-110832 | 53,90 | PB3.0-P110832 | 63,90 |
| PZ-WG - Knopf ger. DIN R/L | PB3.0-11086/7 | 53,90 | PB3.0-P11086/7 | 63,90 |
| PZ-WG - Knopf gekr. DIN R/L | PB3.0-110861/71 | 57,90 | PB3.0-P110861/71 | 67,90 |
| Drückerpaar | | | | |
| ohne Rosetten | D11080 | 19,90 | DP11080 | 27,90 |

Standard-Türstärken: 38 - 42 mm
 Aufpreis für Türstärken ab 42 mm: € 5,00

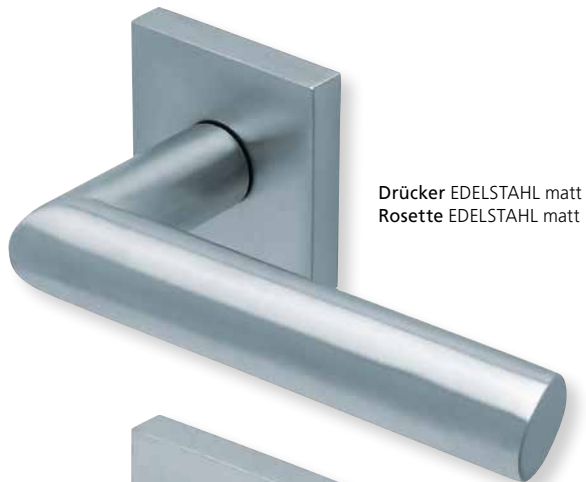

Drücker EDELSTAHL matt
Rosette EDELSTAHL matt



Drücker EDELSTAHL poliert
Rosette EDELSTAHL poliert

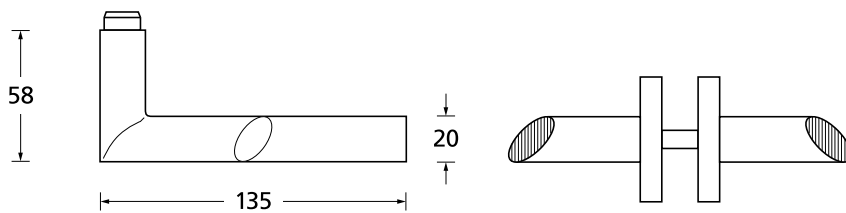



Pullbloc® 3.0 Kugellagertechnik



BB - Garnitur EDELSTAHL poliert



PZ - Garnitur EDELSTAHL poliert



WC - Garnitur EDELSTAHL poliert
WC - Garnitur rot/weiß Anzeige EDELSTAHL poliert
WC - Garnitur rot/grün Anzeige EDELSTAHL poliert



PZ - Wechselgarnitur Knopf gerade
EDELSTAHL poliert



RZ - Garnitur EDELSTAHL poliert



PZ - Wechselgarnitur Knopf gekröpft
EDELSTAHL poliert

Form 1108 auf Quadratrosette

| Rosettengarnitur | Edelstahl matt | | Edelstahl poliert | |
|---------------------------------------|------------------|---------------|-------------------|---------------|
| | | € exkl. MwSt. | | € exkl. MwSt. |
| BB - Garnitur | PB3.0-Q11080 | 45,90 | PB3.0-QP11080 | 55,90 |
| PZ - Garnitur | PB3.0-Q11082 | 45,90 | PB3.0-QP11082 | 55,90 |
| OS - Garnitur (ohne Schlüsselrosette) | PB3.0-Q1108OS | 41,90 | PB3.0-QP1108OS | 51,90 |
| RZ - Garnitur | PB3.0-Q11088 | 45,90 | PB3.0-QP11088 | 55,90 |
| WC - Garnitur | PB3.0-Q11083 | 55,90 | PB3.0-QP11083 | 65,90 |
| WC - Garnitur rot/weiß Anz. | PB3.0-Q110831 | 59,90 | PB3.0-QP110831 | 69,90 |
| WC - Garnitur rot/grün Anz. | PB3.0-Q110832 | 59,90 | PB3.0-QP110832 | 69,90 |
| PZ-WG - Knopf ger. DIN R/L | PB3.0-Q11086/7 | 59,90 | PB3.0-QP11086/7 | 69,90 |
| PZ-WG - Knopf gekr. DIN R/L | PB3.0-Q110861/71 | 63,90 | PB3.0-QP110861/71 | 73,90 |
| Drückerpaar | | | | |
| ohne Rosetten | D11080 | 19,90 | DP11080 | 27,90 |

Standard-Türstärken: 38 - 42 mm
Aufpreis für Türstärken ab 42 mm: € 5,00



Drücker EDELSTAHL matt
Rosette EDELSTAHL matt



Drücker EDELSTAHL poliert
Rosette EDELSTAHL poliert

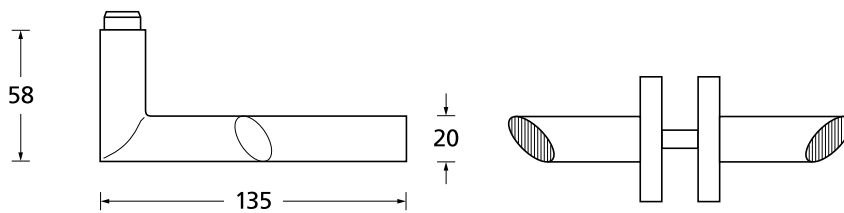



Pullbloc® 3.0 Kugellagertechnik

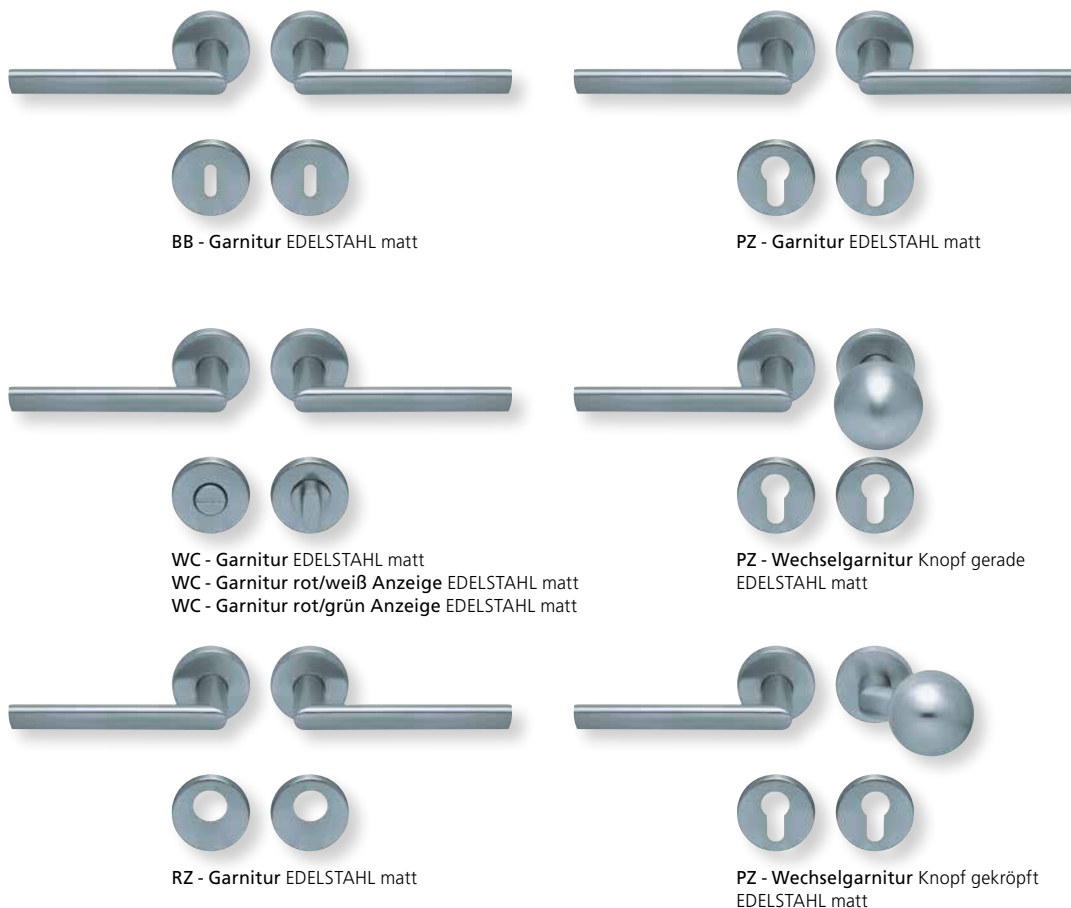

Form 1109 auf Rundrosette

| | Edelstahl matt | | Edelstahl poliert | |
|---------------------------------------|-----------------|---------------|-------------------|---------------|
| | | € exkl. MwSt. | | € exkl. MwSt. |
| Rosettengarnitur | | | | |
| BB - Garnitur | PB3.0-11090 | 39,90 | PB3.0-P11090 | 49,90 |
| PZ - Garnitur | PB3.0-11092 | 39,90 | PB3.0-P11092 | 49,90 |
| OS - Garnitur (ohne Schlüsselrosette) | PB3.0-1109OS | 35,90 | PB3.0-P1109OS | 45,90 |
| RZ - Garnitur | PB3.0-11098 | 39,90 | PB3.0-P11098 | 49,90 |
| WC - Garnitur | PB3.0-11093 | 49,90 | PB3.0-P11093 | 59,90 |
| WC - Garnitur rot/weiß Anz. | PB3.0-110931 | 53,90 | PB3.0-P110931 | 63,90 |
| WC - Garnitur rot/grün Anz. | PB3.0-110932 | 53,90 | PB3.0-P110932 | 63,90 |
| PZ-WG - Knopf ger. DIN R/L | PB3.0-11096/7 | 53,90 | PB3.0-P11096/7 | 63,90 |
| PZ-WG - Knopf gekr. DIN R/L | PB3.0-110961/71 | 57,90 | PB3.0-P110961/71 | 67,90 |
| Drückerpaar | | | | |
| ohne Rosetten | D11090 | 19,90 | DP11090 | 27,90 |

Standard-Türstärken: 38 - 42 mm
 Aufpreis für Türstärken ab 42 mm: € 5,00

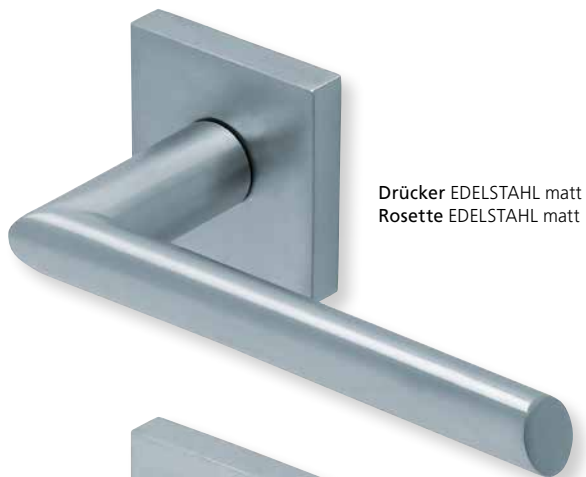

Drücker EDELSTAHL matt
Rosette EDELSTAHL matt



Drücker EDELSTAHL poliert
Rosette EDELSTAHL poliert

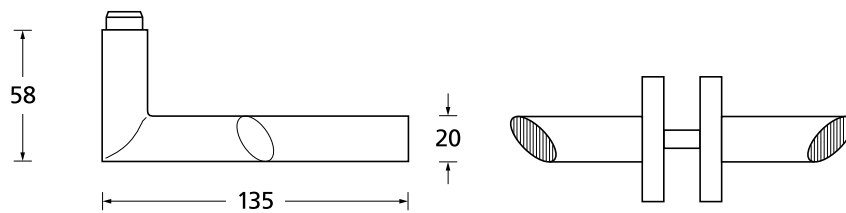



Pullbloc® 3.0 Kugellagertechnik

165

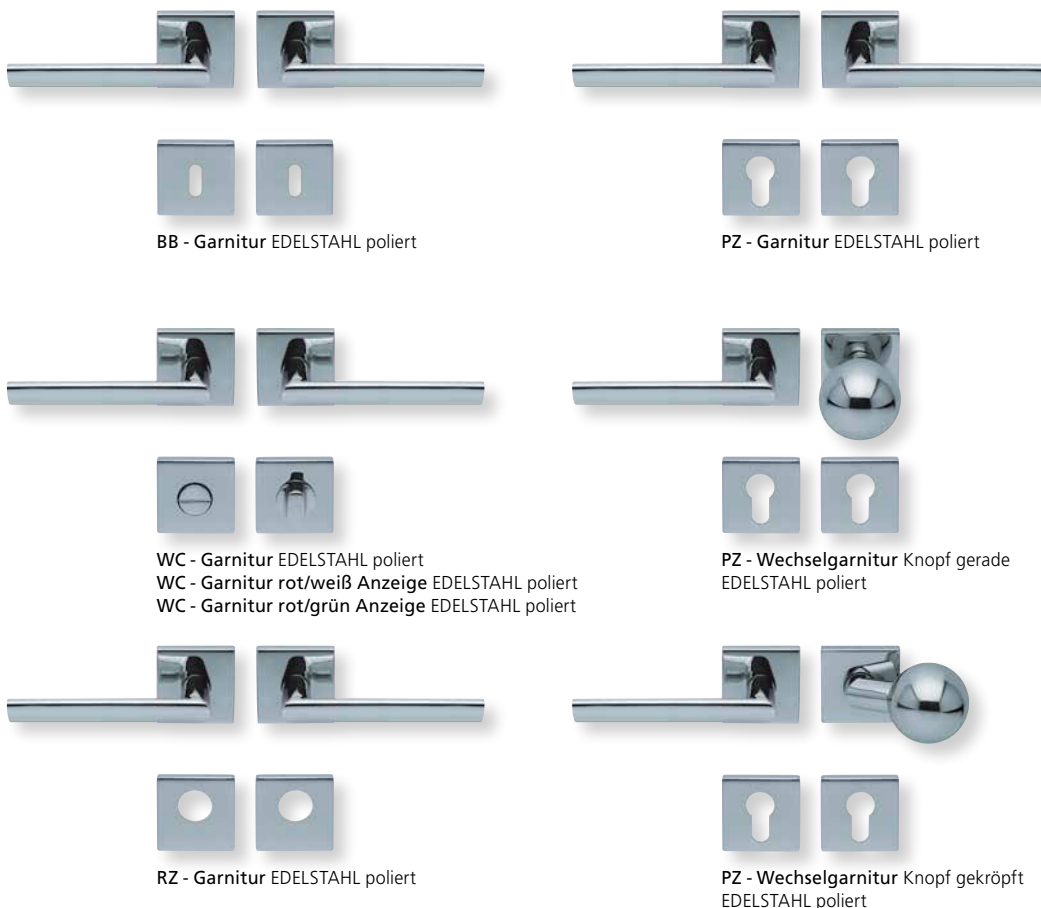

Form 1109 auf Quadratrosette

| | Edelstahl matt | | Edelstahl poliert | |
|---------------------------------------|------------------|---------------|-------------------|---------------|
| | | € exkl. MwSt. | | € exkl. MwSt. |
| Rosettengarnitur | | | | |
| BB - Garnitur | PB3.0-Q11090 | 45,90 | PB3.0-QP11090 | 55,90 |
| PZ - Garnitur | PB3.0-Q11092 | 45,90 | PB3.0-QP11092 | 55,90 |
| OS - Garnitur (ohne Schlüsselrosette) | PB3.0-Q1109OS | 41,90 | PB3.0-QP1109OS | 51,90 |
| RZ - Garnitur | PB3.0-Q11098 | 45,90 | PB3.0-QP11098 | 55,90 |
| WC - Garnitur | PB3.0-Q11093 | 55,90 | PB3.0-QP11093 | 65,90 |
| WC - Garnitur rot/weiß Anz. | PB3.0-Q110931 | 59,90 | PB3.0-QP110931 | 69,90 |
| WC - Garnitur rot/grün Anz. | PB3.0-Q110932 | 59,90 | PB3.0-QP110932 | 69,90 |
| PZ-WG - Knopf ger. DIN R/L | PB3.0-Q11096/7 | 59,90 | PB3.0-QP11096/7 | 69,90 |
| PZ-WG - Knopf gekr. DIN R/L | PB3.0-Q110961/71 | 63,90 | PB3.0-QP110961/71 | 73,90 |
| Drückerpaar | | | | |
| ohne Rosetten | D11090 | 19,90 | DP11090 | 27,90 |

Standard-Türstärken: 38 - 42 mm
 Aufpreis für Türstärken ab 42 mm: € 5,00



Drücker EDELSTAHL poliert/EDELSTAHL matt
Rosette EDELSTAHL matt



Drücker EDELSTAHL poliert/EDELSTAHL matt
Rosette EDELSTAHL poliert

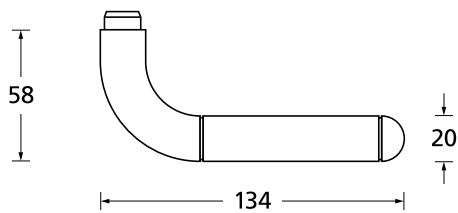



Pullbloc® 3.0 Kugellagertechnik



BB - Garnitur EDELSTAHL poliert



PZ - Garnitur EDELSTAHL poliert



WC - Garnitur EDELSTAHL poliert
WC - Garnitur rot/weiß Anzeige EDELSTAHL poliert
WC - Garnitur rot/grün Anzeige EDELSTAHL poliert



PZ - Wechselgarnitur Knopf gerade EDELSTAHL poliert



RZ - Garnitur EDELSTAHL poliert



PZ - Wechselgarnitur Knopf gekröpft EDELSTAHL poliert

Form 1173 auf Rundrosette

| Rosettengarnitur | Edelstahl matt | | Edelstahl poliert | |
|---------------------------------------|-----------------|---------------|-------------------|---------------|
| | | € exkl. MwSt. | | € exkl. MwSt. |
| BB - Garnitur | PB3.0-11730 | 41,90 | PB3.0-P11730 | 47,90 |
| PZ - Garnitur | PB3.0-11732 | 41,90 | PB3.0-P11732 | 47,90 |
| OS - Garnitur (ohne Schlüsselrosette) | PB3.0-1173OS | 37,90 | PB3.0-P1173OS | 43,90 |
| RZ - Garnitur | PB3.0-11738 | 41,90 | PB3.0-P11738 | 47,90 |
| WC - Garnitur | PB3.0-11733 | 51,90 | PB3.0-P11733 | 57,90 |
| WC - Garnitur rot/weiß Anz. | PB3.0-117331 | 55,90 | PB3.0-P117331 | 61,90 |
| WC - Garnitur rot/grün Anz. | PB3.0-117332 | 55,90 | PB3.0-P117332 | 61,90 |
| PZ-WG - Knopf ger. DIN R/L | PB3.0-11736/7 | 55,90 | PB3.0-P11736/7 | 61,90 |
| PZ-WG - Knopf gekr. DIN R/L | PB3.0-117361/71 | 59,90 | PB3.0-P117361/71 | 65,90 |
| Drückerpaar | | | | |
| ohne Rosetten | D11730 | 21,90 | D11730 | 21,90 |

Standard-Türstärken: 38 - 42 mm
Aufpreis für Türstärken ab 42 mm: € 5,00



Drücker EDELSTAHL poliert/EDELSTAHL matt
Rosette EDELSTAHL matt



Drücker EDELSTAHL poliert/EDELSTAHL matt
Rosette EDELSTAHL poliert

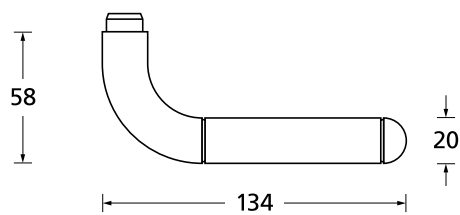



Pullbloc® 3.0 Kugellagertechnik

169



BB - Garnitur EDELSTAHL poliert



PZ - Garnitur EDELSTAHL poliert



WC - Garnitur EDELSTAHL poliert
WC - Garnitur rot/weiß Anzeige EDELSTAHL poliert
WC - Garnitur rot/grün Anzeige EDELSTAHL poliert



PZ - Wechselgarnitur Knopf gerade
EDELSTAHL poliert



RZ - Garnitur EDELSTAHL poliert



PZ - Wechselgarnitur Knopf gekröpft
EDELSTAHL poliert

Form 1173 auf Quadratrosette

| Rosettengarnitur | Edelstahl matt | | Edelstahl poliert | |
|---------------------------------------|------------------|---------------|-------------------|---------------|
| | | € exkl. MwSt. | | € exkl. MwSt. |
| BB - Garnitur | PB3.0-Q11730 | 47,90 | PB3.0-QP11730 | 53,90 |
| PZ - Garnitur | PB3.0-Q11732 | 47,90 | PB3.0-QP11732 | 53,90 |
| OS - Garnitur (ohne Schlüsselrosette) | PB3.0-Q11730S | 43,90 | PB3.0-QP11730S | 49,90 |
| RZ - Garnitur | PB3.0-Q11738 | 47,90 | PB3.0-QP11738 | 53,90 |
| WC - Garnitur | PB3.0-Q11733 | 57,90 | PB3.0-QP11733 | 63,90 |
| WC - Garnitur rot/weiß Anz. | PB3.0-Q117331 | 61,90 | PB3.0-QP117331 | 67,90 |
| WC - Garnitur rot/grün Anz. | PB3.0-Q117332 | 61,90 | PB3.0-QP117332 | 67,90 |
| PZ-WG - Knopf ger. DIN R/L | PB3.0-Q11736/7 | 61,90 | PB3.0-QP11736/7 | 67,90 |
| PZ-WG - Knopf gekr. DIN R/L | PB3.0-Q117361/71 | 65,90 | PB3.0-QP117361/71 | 71,90 |
| Drückerpaar | | | | |
| ohne Rosetten | D11730 | 21,90 | D11730 | 21,90 |

Standard-Türstärken: 38 - 42 mm
Aufpreis für Türstärken ab 42 mm: € 5,00



Drücker EDELSTAHL poliert/EDELSTAHL matt
Rosette EDELSTAHL matt



Drücker EDELSTAHL poliert/EDELSTAHL matt
Rosette EDELSTAHL poliert

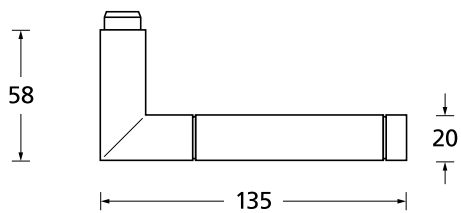



Pullbloc® 3.0 Kugellagertechnik

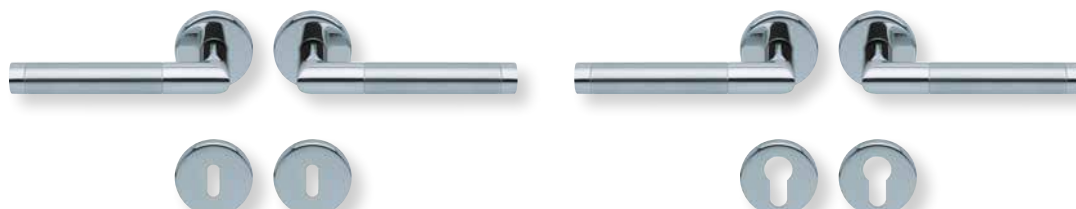

BB - Garnitur EDELSTAHL poliert

PZ - Garnitur EDELSTAHL poliert



WC - Garnitur EDELSTAHL poliert
WC - Garnitur rot/weiß Anzeige EDELSTAHL poliert
WC - Garnitur rot/grün Anzeige EDELSTAHL poliert



PZ - Wechselgarnitur Knopf gerade EDELSTAHL poliert



RZ - Garnitur EDELSTAHL poliert



PZ - Wechselgarnitur Knopf gekröpft EDELSTAHL poliert

Form 1174 auf Rundrosette

| | Edelstahl matt | | Edelstahl poliert | |
|---------------------------------------|-----------------|-------|-------------------|-------|
| | € exkl. MwSt. | | € exkl. MwSt. | |
| Rosettengarnitur | | | | |
| BB - Garnitur | PB3.0-11740 | 41,90 | PB3.0-P11740 | 47,90 |
| PZ - Garnitur | PB3.0-11742 | 41,90 | PB3.0-P11742 | 47,90 |
| OS - Garnitur (ohne Schlüsselrosette) | PB3.0-1174OS | 37,90 | PB3.0-P1174OS | 43,90 |
| RZ - Garnitur | PB3.0-11748 | 41,90 | PB3.0-P11748 | 47,90 |
| WC - Garnitur | PB3.0-11743 | 51,90 | PB3.0-P11743 | 57,90 |
| WC - Garnitur rot/weiß Anz. | PB3.0-117431 | 55,90 | PB3.0-P117431 | 61,90 |
| WC - Garnitur rot/grün Anz. | PB3.0-117432 | 55,90 | PB3.0-P117432 | 61,90 |
| PZ-WG - Knopf ger. DIN R/L | PB3.0-11746/7 | 55,90 | PB3.0-P11746/7 | 61,90 |
| PZ-WG - Knopf gekr. DIN R/L | PB3.0-117461/71 | 59,90 | PB3.0-P117461/71 | 65,90 |
| Drückerpaar | | | | |
| ohne Rosetten | D11740 | 21,90 | D11740 | 21,90 |

Standard-Türstärken: 38 - 42 mm
Aufpreis für Türstärken ab 42 mm: € 5,00



Drücker EDELSTAHL poliert/EDELSTAHL matt
Rosette EDELSTAHL matt



Drücker EDELSTAHL poliert/EDELSTAHL matt
Rosette EDELSTAHL poliert

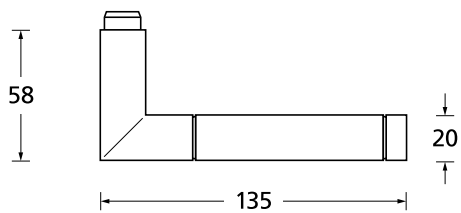



Pullbloc® 3.0 Kugellagertechnik

173



BB - Garnitur EDELSTAHL poliert



PZ - Garnitur EDELSTAHL poliert



WC - Garnitur EDELSTAHL poliert
WC - Garnitur rot/weiß Anzeige EDELSTAHL poliert
WC - Garnitur rot/grün Anzeige EDELSTAHL poliert



PZ - Wechselgarnitur Knopf gerade
EDELSTAHL poliert



RZ - Garnitur EDELSTAHL poliert



PZ - Wechselgarnitur Knopf gekröpft
EDELSTAHL poliert

Form 1174 auf Quadratrosette

| | Edelstahl matt | | Edelstahl poliert | |
|---------------------------------------|------------------|---------------|-------------------|---------------|
| | | € exkl. MwSt. | | € exkl. MwSt. |
| Rosettengarnitur | | | | |
| BB - Garnitur | PB3.0-Q11740 | 47,90 | PB3.0-QP11740 | 53,90 |
| PZ - Garnitur | PB3.0-Q11742 | 47,90 | PB3.0-QP11742 | 53,90 |
| OS - Garnitur (ohne Schlüsselrosette) | PB3.0-Q11740S | 43,90 | PB3.0-QP11740S | 49,90 |
| RZ - Garnitur | PB3.0-Q11748 | 47,90 | PB3.0-QP11748 | 53,90 |
| WC - Garnitur | PB3.0-Q11743 | 57,90 | PB3.0-QP11743 | 63,90 |
| WC - Garnitur rot/weiß Anz. | PB3.0-Q117431 | 61,90 | PB3.0-QP117431 | 67,90 |
| WC - Garnitur rot/grün Anz. | PB3.0-Q117432 | 61,90 | PB3.0-QP117432 | 67,90 |
| PZ-WG - Knopf ger. DIN R/L | PB3.0-Q11746/7 | 61,90 | PB3.0-QP11746/7 | 67,90 |
| PZ-WG - Knopf gekr. DIN R/L | PB3.0-Q117461/71 | 65,90 | PB3.0-QP117461/71 | 71,90 |
| Drückerpaar | | | | |
| ohne Rosetten | D11740 | 21,90 | D11740 | 21,90 |

Standard-Türstärken: 38 - 42 mm
Aufpreis für Türstärken ab 42 mm: € 5,00



Drücker EDELSTAHL matt
Rosette EDELSTAHL matt



Drücker EDELSTAHL poliert
Rosette EDELSTAHL poliert

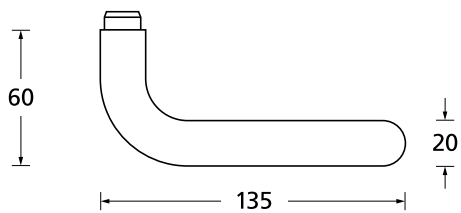



Pullbloc® 3.0 Kugellagertechnik

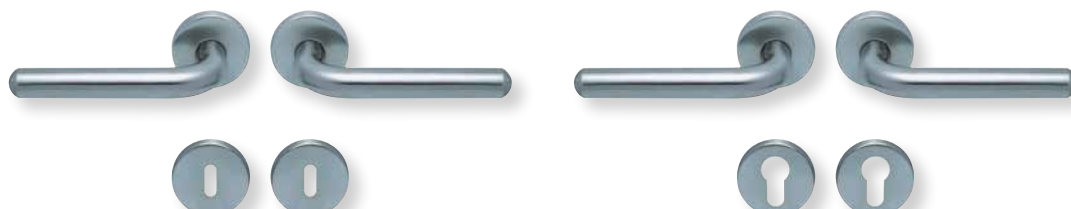

BB - Garnitur EDELSTAHL matt

PZ - Garnitur EDELSTAHL matt

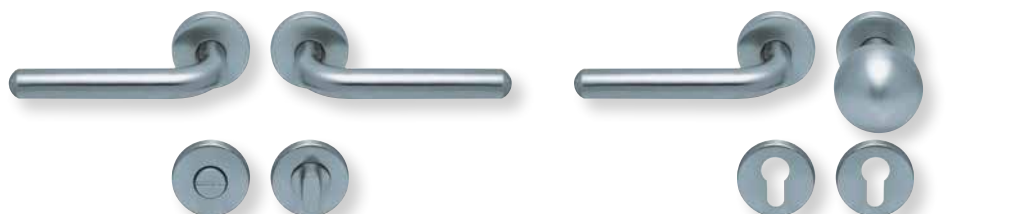

WC - Garnitur EDELSTAHL matt
WC - Garnitur rot/weiß Anzeige EDELSTAHL matt
WC - Garnitur rot/grün Anzeige EDELSTAHL matt

PZ - Wechselgarnitur Knopf gerade EDELSTAHL matt

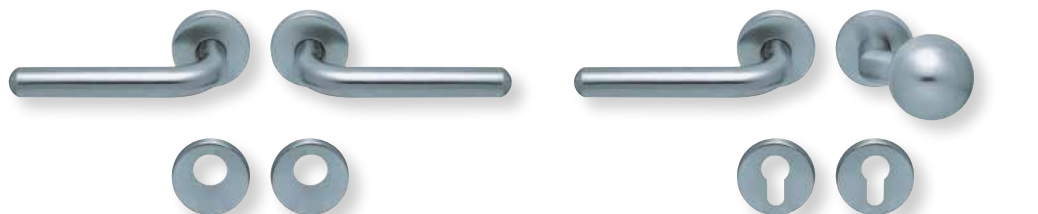

RZ - Garnitur EDELSTAHL matt

PZ - Wechselgarnitur Knopf gekröpft EDELSTAHL matt

Form 1200 auf Rundrosette

| | Edelstahl matt | | Edelstahl poliert | |
|---------------------------------------|-----------------|---------------|-------------------|---------------|
| | | € exkl. MwSt. | | € exkl. MwSt. |
| Rosettengarnitur | | | | |
| BB - Garnitur | PB3.0-12000 | 39,90 | PB3.0-P12000 | 49,90 |
| PZ - Garnitur | PB3.0-12002 | 39,90 | PB3.0-P12002 | 49,90 |
| OS - Garnitur (ohne Schlüsselrosette) | PB3.0-12000S | 35,90 | PB3.0-P12000S | 45,90 |
| RZ - Garnitur | PB3.0-12008 | 39,90 | PB3.0-P12008 | 49,90 |
| WC - Garnitur | PB3.0-12003 | 49,90 | PB3.0-P12003 | 59,90 |
| WC - Garnitur rot/weiß Anz. | PB3.0-120031 | 53,90 | PB3.0-P120031 | 63,90 |
| WC - Garnitur rot/grün Anz. | PB3.0-120032 | 53,90 | PB3.0-P120032 | 63,90 |
| PZ-WG - Knopf ger. DIN R/L | PB3.0-12005/6 | 53,90 | PB3.0-P12005/6 | 63,90 |
| PZ-WG - Knopf gekr. DIN R/L | PB3.0-120051/61 | 57,90 | PB3.0-P120051/61 | 67,90 |
| Drückerpaar | | | | |
| ohne Rosetten | D12001 | 19,90 | DP12001 | 27,90 |

Standard-Türstärken: 38 - 42 mm
Aufpreis für Türstärken ab 42 mm: € 5,00



Drücker EDELSTAHL matt
Rosette EDELSTAHL matt



Drücker EDELSTAHL poliert
Rosette EDELSTAHL poliert

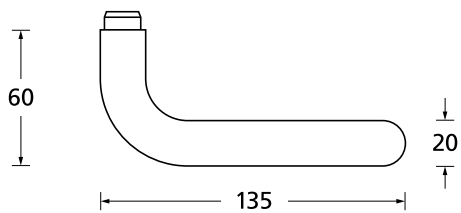



Pullbloc® 3.0 Kugellagertechnik



BB - Garnitur EDELSTAHL poliert



PZ - Garnitur EDELSTAHL poliert



WC - Garnitur EDELSTAHL poliert
WC - Garnitur rot/weiß Anzeige EDELSTAHL poliert
WC - Garnitur rot/grün Anzeige EDELSTAHL poliert



PZ - Wechselgarnitur Knopf gerade
EDELSTAHL poliert



RZ - Garnitur EDELSTAHL poliert



PZ - Wechselgarnitur Knopf gekröpft
EDELSTAHL poliert

Form 1200 auf Quadratrosette

| Rosettengarnitur | Edelstahl matt | | Edelstahl poliert | |
|---------------------------------------|------------------|---------------|-------------------|---------------|
| | | € exkl. MwSt. | | € exkl. MwSt. |
| BB - Garnitur | PB3.0-Q12000 | 45,90 | PB3.0-QP12000 | 55,90 |
| PZ - Garnitur | PB3.0-Q12002 | 45,90 | PB3.0-QP12002 | 55,90 |
| OS - Garnitur (ohne Schlüsselrosette) | PB3.0-Q12000S | 41,90 | PB3.0-QP12000S | 51,90 |
| RZ - Garnitur | PB3.0-Q12008 | 45,90 | PB3.0-QP12008 | 55,90 |
| WC - Garnitur | PB3.0-Q12003 | 55,90 | PB3.0-QP12003 | 65,90 |
| WC - Garnitur rot/weiß Anz. | PB3.0-Q120031 | 59,90 | PB3.0-QP120031 | 69,90 |
| WC - Garnitur rot/grün Anz. | PB3.0-Q120032 | 59,90 | PB3.0-QP120032 | 69,90 |
| PZ-WG - Knopf ger. DIN R/L | PB3.0-Q12005/6 | 59,90 | PB3.0-QP12005/6 | 69,90 |
| PZ-WG - Knopf gekr. DIN R/L | PB3.0-Q120051/61 | 63,90 | PB3.0-QP120051/61 | 73,90 |
| Drückerpaar | | | | |
| ohne Rosetten | D12001 | 19,90 | DP12001 | 27,90 |

Standard-Türstärken: 38 - 42 mm
Aufpreis für Türstärken ab 42 mm: € 5,00

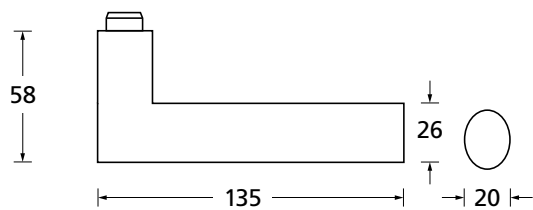



Pullbloc® 3.0 Kugellagertechnik

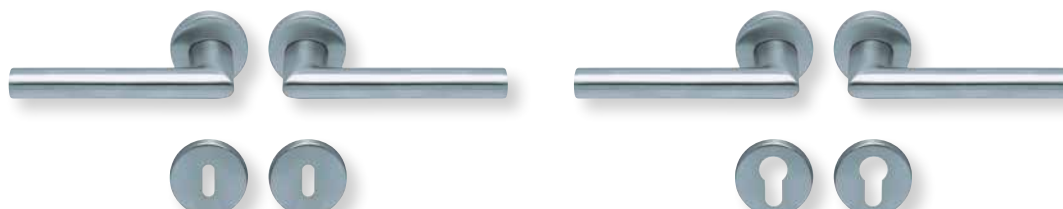

BB - Garnitur EDELSTAHL matt

PZ - Garnitur EDELSTAHL matt

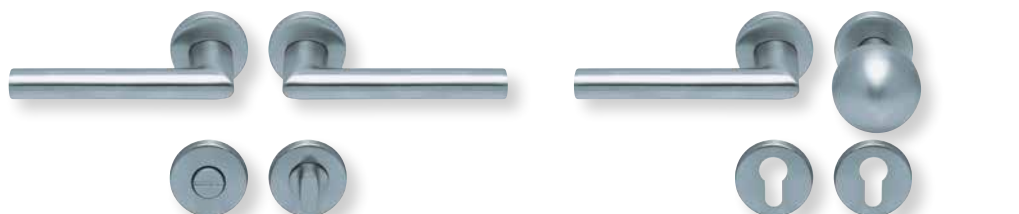

WC - Garnitur EDELSTAHL matt
WC - Garnitur rot/weiß Anzeige EDELSTAHL matt
WC - Garnitur rot/grün Anzeige EDELSTAHL matt

PZ - Wechselgarnitur Knopf gerade EDELSTAHL matt

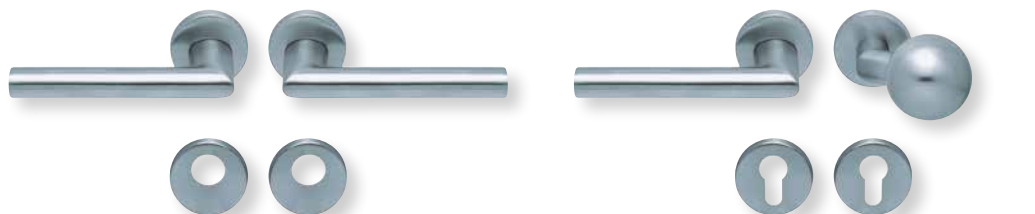

RZ - Garnitur EDELSTAHL matt

PZ - Wechselgarnitur Knopf gekröpft EDELSTAHL matt

Form 1206 auf Rundrosette

Edelstahl matt

Rosettengarnitur

| | | € exkl. MwSt. |
|---------------------------------------|-----------------|---------------|
| BB - Garnitur | PB3.0-12060 | 41,90 |
| PZ - Garnitur | PB3.0-12062 | 41,90 |
| OS - Garnitur (ohne Schlüsselrosette) | PB3.0-1206OS | 37,90 |
| RZ - Garnitur | PB3.0-12068 | 41,90 |
| WC - Garnitur | PB3.0-12063 | 51,90 |
| WC - Garnitur rot/weiß Anz. | PB3.0-120631 | 55,90 |
| WC - Garnitur rot/grün Anz. | PB3.0-120632 | 55,90 |
| PZ-WG - Knopf ger. DIN R/L | PB3.0-12065/6 | 55,90 |
| PZ-WG - Knopf gekr. DIN R/L | PB3.0-120651/61 | 59,90 |

Drückerpaar

| | | |
|---------------|--------|-------|
| ohne Rosetten | D12060 | 21,90 |
|---------------|--------|-------|

Standard-Türstärken: 38 - 42 mm
Aufpreis für Türstärken ab 42 mm: € 5,00

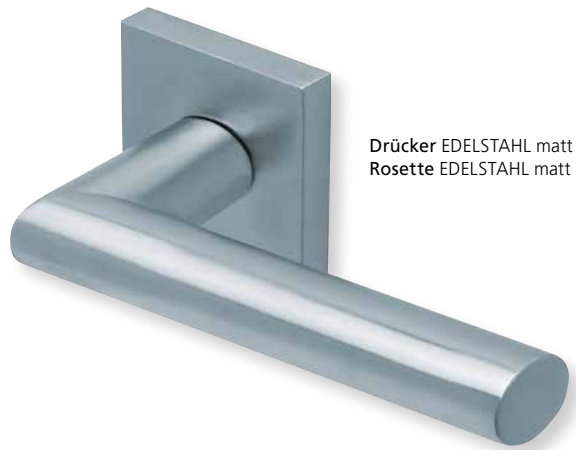

Drücker EDELSTAHL matt
Rosette EDELSTAHL matt

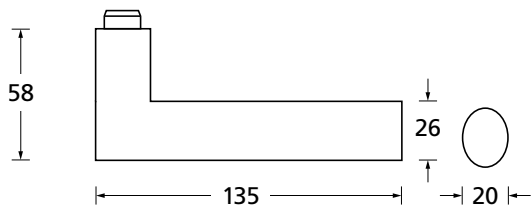



Pullbloc® 3.0 Kugellagertechnik

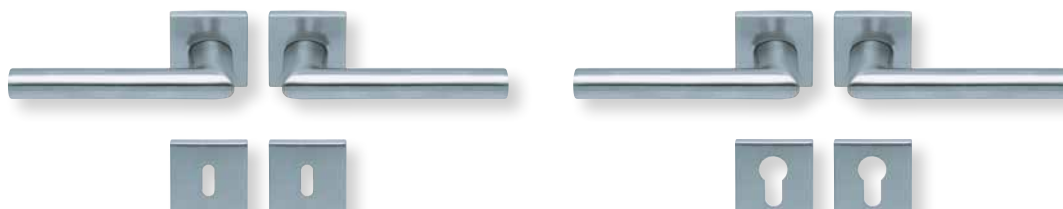

BB - Garnitur EDELSTAHL matt

PZ - Garnitur EDELSTAHL matt

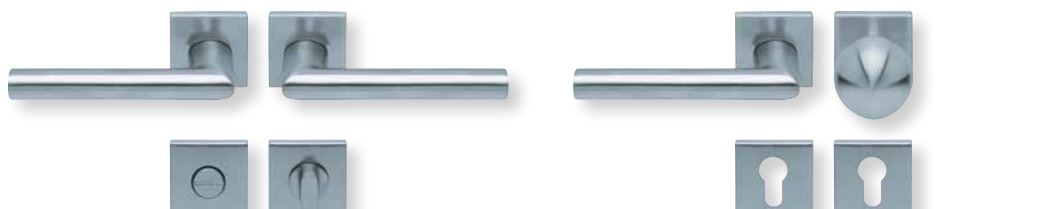

WC - Garnitur EDELSTAHL matt
WC - Garnitur rot/weiß Anzeige EDELSTAHL matt
WC - Garnitur rot/grün Anzeige EDELSTAHL matt

PZ - Wechselgarnitur Knopf gerade EDELSTAHL matt

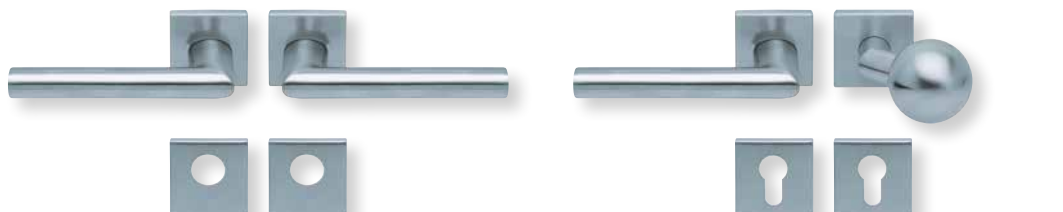

RZ - Garnitur EDELSTAHL matt

PZ - Wechselgarnitur Knopf gekröpft EDELSTAHL matt

Form 1206 auf Quadratrosette

Edelstahl matt

Rosettengarnitur

| | | € exkl. MwSt. |
|---------------------------------------|------------------|---------------|
| BB - Garnitur | PB3.0-Q12060 | 47,90 |
| PZ - Garnitur | PB3.0-Q12062 | 47,90 |
| OS - Garnitur (ohne Schlüsselrosette) | PB3.0-Q1206OS | 43,90 |
| RZ - Garnitur | PB3.0-Q12068 | 47,90 |
| WC - Garnitur | PB3.0-Q12063 | 57,90 |
| WC - Garnitur rot/weiß Anz. | PB3.0-Q120631 | 61,90 |
| WC - Garnitur rot/grün Anz. | PB3.0-Q120632 | 61,90 |
| PZ-WG - Knopf ger. DIN R/L | PB3.0-Q12065/6 | 61,90 |
| PZ-WG - Knopf gekr. DIN R/L | PB3.0-Q120651/61 | 65,90 |

Drückerpaar

| | | |
|---------------|--------|-------|
| ohne Rosetten | D12060 | 21,90 |
|---------------|--------|-------|

Standard-Türstärken: 38 - 42 mm
Aufpreis für Türstärken ab 42 mm: € 5,00



Drücker EDELSTAHL poliert/EDELSTAHL matt
Rosette EDELSTAHL matt

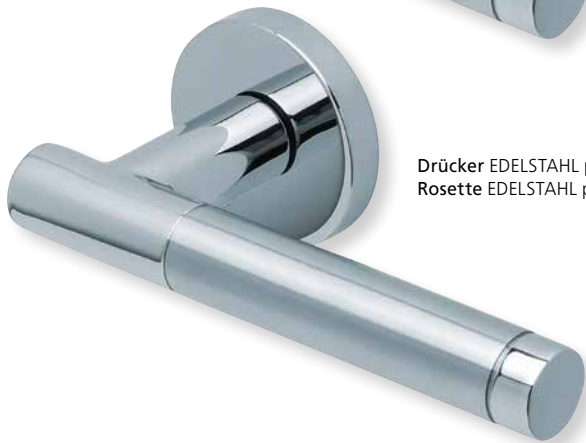

Drücker EDELSTAHL poliert/EDELSTAHL matt
Rosette EDELSTAHL poliert

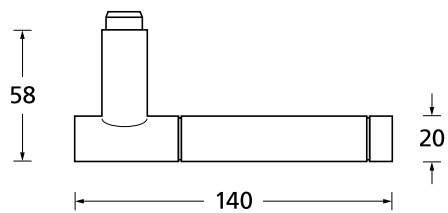



Pullbloc® 3.0 Kugellagertechnik



BB - Garnitur EDELSTAHL poliert



PZ - Garnitur EDELSTAHL poliert



WC - Garnitur EDELSTAHL poliert
WC - Garnitur rot/weiß Anzeige EDELSTAHL poliert
WC - Garnitur rot/grün Anzeige EDELSTAHL poliert



PZ - Wechselgarnitur Knopf gerade EDELSTAHL poliert



RZ - Garnitur EDELSTAHL poliert



PZ - Wechselgarnitur Knopf gekröpft EDELSTAHL poliert

Form 1275 auf Rundrosette

| | Edelstahl matt | | Edelstahl poliert | |
|---------------------------------------|-----------------|---------------|-------------------|---------------|
| | | € exkl. MwSt. | | € exkl. MwSt. |
| Rosettengarnitur | | | | |
| BB - Garnitur | PB3.0-12750 | 45,90 | PB3.0-P12750 | 51,90 |
| PZ - Garnitur | PB3.0-12752 | 45,90 | PB3.0-P12752 | 51,90 |
| OS - Garnitur (ohne Schlüsselrosette) | PB3.0-12750S | 41,90 | PB3.0-P12750S | 47,90 |
| RZ - Garnitur | PB3.0-12758 | 45,90 | PB3.0-P12758 | 51,90 |
| WC - Garnitur | PB3.0-12753 | 55,90 | PB3.0-P12753 | 61,90 |
| WC - Garnitur rot/weiß Anz. | PB3.0-127531 | 59,90 | PB3.0-P127531 | 65,90 |
| WC - Garnitur rot/grün Anz. | PB3.0-127532 | 59,90 | PB3.0-P127532 | 65,90 |
| PZ-WG - Knopf ger. DIN R/L | PB3.0-12755/6 | 59,90 | PB3.0-P12755/6 | 65,90 |
| PZ-WG - Knopf gekr. DIN R/L | PB3.0-127551/61 | 63,90 | PB3.0-P127551/61 | 69,90 |
| Drückerpaar | | | | |
| ohne Rosetten | D12750 | 25,90 | D12750 | 25,90 |

Standard-Türstärken: 38 - 42 mm
Aufpreis für Türstärken ab 42 mm: € 5,00



Drücker EDELSTAHL poliert/EDELSTAHL matt
Rosette EDELSTAHL matt



Drücker EDELSTAHL poliert/EDELSTAHL matt
Rosette EDELSTAHL poliert

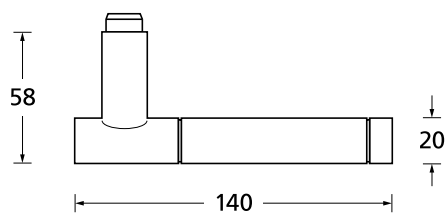



Pullbloc® 3.0 Kugellagertechnik



BB - Garnitur EDELSTAHL poliert



PZ - Garnitur EDELSTAHL poliert



WC - Garnitur EDELSTAHL poliert
WC - Garnitur rot/weiß Anzeige EDELSTAHL poliert
WC - Garnitur rot/grün Anzeige EDELSTAHL poliert



PZ - Wechselgarnitur Knopf gerade EDELSTAHL poliert



RZ - Garnitur EDELSTAHL poliert



PZ - Wechselgarnitur Knopf gekröpft EDELSTAHL poliert

Form 1275 auf Quadratrosette

| Rosettengarnitur | Edelstahl matt | | Edelstahl poliert | |
|---------------------------------------|------------------|---------------|-------------------|---------------|
| | | € exkl. MwSt. | | € exkl. MwSt. |
| BB - Garnitur | PB3.0-Q12750 | 51,90 | PB3.0-QP12750 | 57,90 |
| PZ - Garnitur | PB3.0-Q12752 | 51,90 | PB3.0-QP12752 | 57,90 |
| OS - Garnitur (ohne Schlüsselrosette) | PB3.0-Q12750S | 47,90 | PB3.0-QP12750S | 53,90 |
| RZ - Garnitur | PB3.0-Q12758 | 51,90 | PB3.0-QP12758 | 57,90 |
| WC - Garnitur | PB3.0-Q12753 | 61,90 | PB3.0-QP12753 | 67,90 |
| WC - Garnitur rot/weiß Anz. | PB3.0-Q127531 | 65,90 | PB3.0-QP127531 | 71,90 |
| WC - Garnitur rot/grün Anz. | PB3.0-Q127532 | 65,90 | PB3.0-QP127532 | 71,90 |
| PZ-WG - Knopf ger. DIN R/L | PB3.0-Q12755/6 | 65,90 | PB3.0-QP12755/6 | 71,90 |
| PZ-WG - Knopf gekr. DIN R/L | PB3.0-Q127551/61 | 69,90 | PB3.0-QP127551/61 | 75,90 |
| Drückerpaar | | | | |
| ohne Rosetten | D12750 | 25,90 | D12750 | 25,90 |

Standard-Türstärken: 38 - 42 mm
Aufpreis für Türstärken ab 42 mm: € 5,00



Drücker verchromt/nickelmatt
Rosette EDELSTAHL matt



Drücker verchromt/nickelmatt
Rosette EDELSTAHL poliert

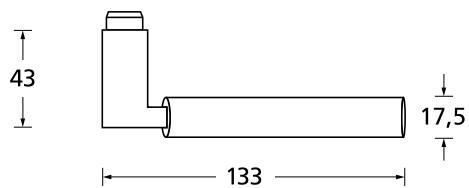



Pullbloc® 3.0 Kugellagertechnik

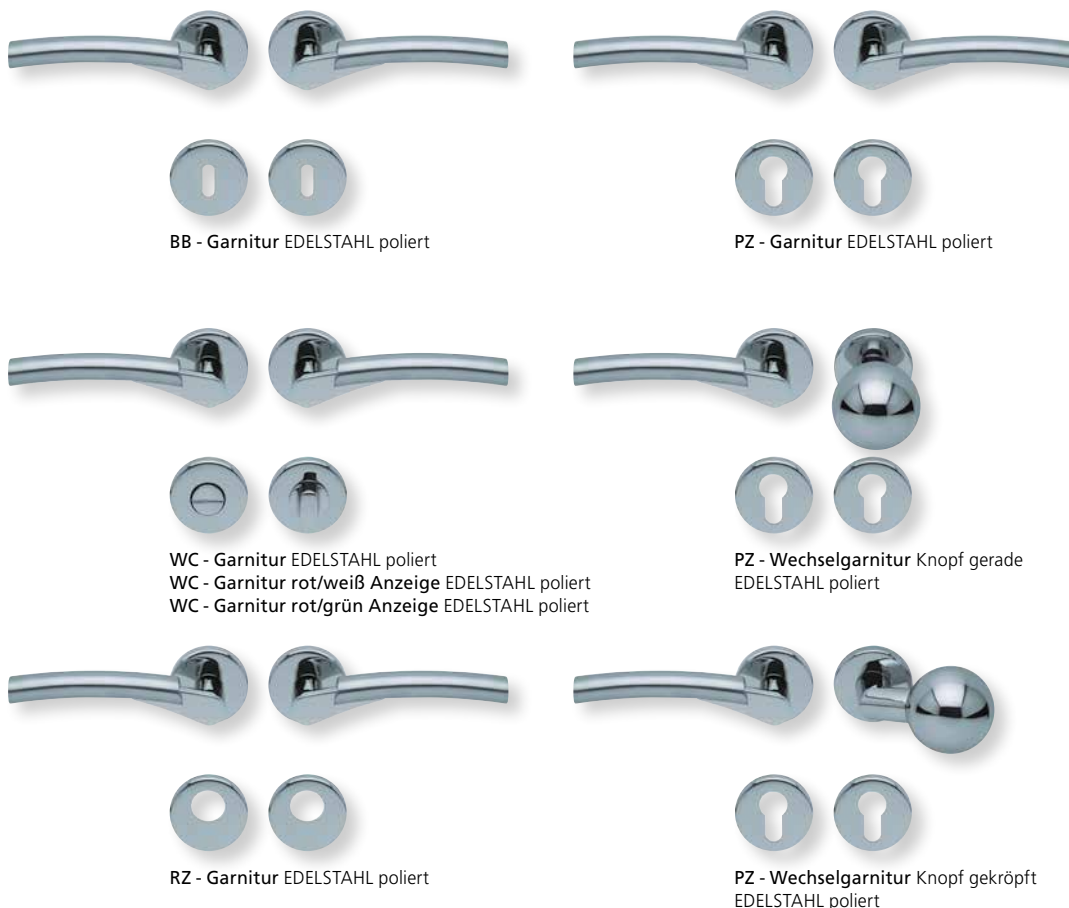

Form 1764 auf Rundrosette

| | Edelstahl matt | | Edelstahl poliert | |
|---------------------------------------|-----------------|---------------|-------------------|---------------|
| | | € exkl. MwSt. | | € exkl. MwSt. |
| Rosettengarnitur | | | | |
| BB - Garnitur | PB3.0-17640 | 45,90 | PB3.0-P17640 | 51,90 |
| PZ - Garnitur | PB3.0-17642 | 45,90 | PB3.0-P17642 | 51,90 |
| OS - Garnitur (ohne Schlüsselrosette) | PB3.0-1764OS | 41,90 | PB3.0-P1764OS | 47,90 |
| RZ - Garnitur | PB3.0-17648 | 45,90 | PB3.0-P17648 | 51,90 |
| WC - Garnitur | PB3.0-17643 | 55,90 | PB3.0-P17643 | 61,90 |
| WC - Garnitur rot/weiß Anz. | PB3.0-176431 | 59,90 | PB3.0-P176431 | 65,90 |
| WC - Garnitur rot/grün Anz. | PB3.0-176432 | 59,90 | PB3.0-P176432 | 65,90 |
| PZ-WG - Knopf ger. DIN R/L | PB3.0-17645/6 | 59,90 | PB3.0-P17645/6 | 65,90 |
| PZ-WG - Knopf gekr. DIN R/L | PB3.0-176451/61 | 63,90 | PB3.0-P176451/61 | 69,90 |
| Drückerpaar | | | | |
| ohne Rosetten | D17640 | 25,90 | D17640 | 25,90 |

Standard-Türstärken: 38 - 42 mm
 Aufpreis für Türstärken ab 42 mm: € 5,00



Drücker verchromt/nickelmatt
Rosette EDELSTAHL matt



Drücker verchromt/nickelmatt
Rosette EDELSTAHL poliert

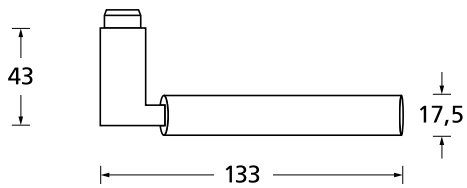



Pullbloc® 3.0 Kugellagertechnik



BB - Garnitur EDELSTAHL poliert



PZ - Garnitur EDELSTAHL poliert



WC - Garnitur EDELSTAHL poliert
WC - Garnitur rot/weiß Anzeige EDELSTAHL poliert
WC - Garnitur rot/grün Anzeige EDELSTAHL poliert



PZ - Wechselgarnitur Knopf gerade
EDELSTAHL poliert



RZ - Garnitur EDELSTAHL poliert



PZ - Wechselgarnitur Knopf gekröpft
EDELSTAHL poliert

Form 1764 auf Quadratrosette

| | Edelstahl matt | | Edelstahl poliert | |
|---------------------------------------|------------------|-------|-------------------|-------|
| | € exkl. MwSt. | | € exkl. MwSt. | |
| Rosettengarnitur | | | | |
| BB - Garnitur | PB3.0-Q17640 | 51,90 | PB3.0-QP17640 | 57,90 |
| PZ - Garnitur | PB3.0-Q17642 | 51,90 | PB3.0-QP17642 | 57,90 |
| OS - Garnitur (ohne Schlüsselrosette) | PB3.0-Q1764OS | 47,90 | PB3.0-QP1764OS | 53,90 |
| RZ - Garnitur | PB3.0-Q17648 | 51,90 | PB3.0-QP17648 | 57,90 |
| WC - Garnitur | PB3.0-Q17643 | 61,90 | PB3.0-QP17643 | 67,90 |
| WC - Garnitur rot/weiß Anz. | PB3.0-Q176431 | 65,90 | PB3.0-QP176431 | 71,90 |
| WC - Garnitur rot/grün Anz. | PB3.0-Q176432 | 65,90 | PB3.0-QP176432 | 71,90 |
| PZ-WG - Knopf ger. DIN R/L | PB3.0-Q17645/6 | 65,90 | PB3.0-QP17645/6 | 71,90 |
| PZ-WG - Knopf gekr. DIN R/L | PB3.0-Q176451/61 | 69,90 | PB3.0-QP176451/61 | 75,90 |
| Drückerpaar | | | | |
| ohne Rosetten | D17640 | 25,90 | D17640 | 25,90 |

Standard-Türstärken: 38 - 42 mm
Aufpreis für Türstärken ab 42 mm: € 5,00

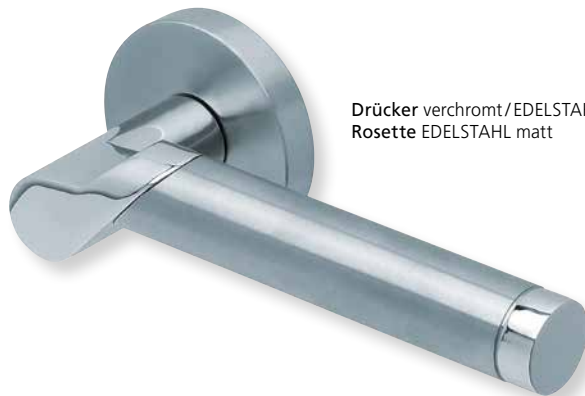

Drücker verchromt/EDELSTAHL matt
Rosette EDELSTAHL matt



Drücker verchromt/EDELSTAHL matt
Rosette EDELSTAHL poliert

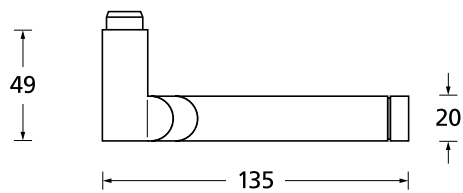



Pullbloc® 3.0 Kugellagertechnik

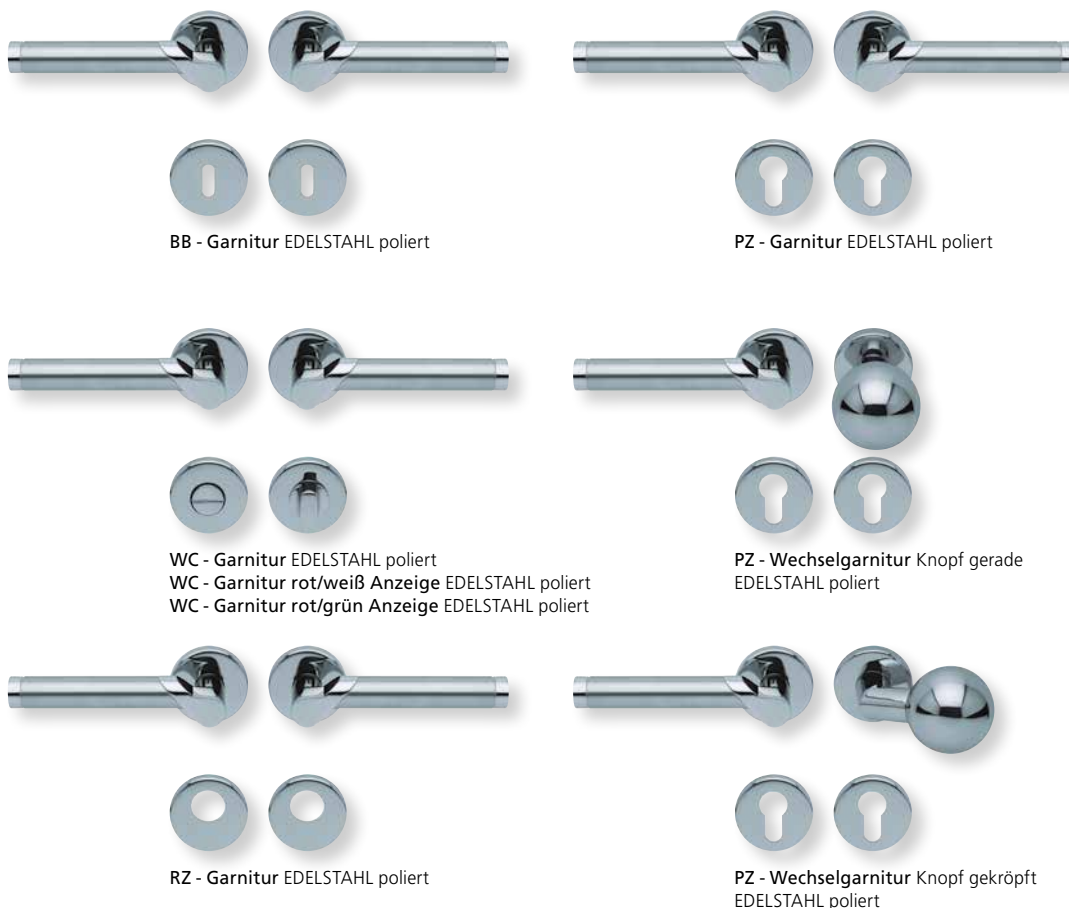

Form 1765 auf Rundrosette

| | Edelstahl matt | | Edelstahl poliert | |
|---------------------------------------|-----------------|---------------|-------------------|---------------|
| | | € exkl. MwSt. | | € exkl. MwSt. |
| Rosettengarnitur | | | | |
| BB - Garnitur | PB3.0-17650 | 45,90 | PB3.0-P17650 | 51,90 |
| PZ - Garnitur | PB3.0-17652 | 45,90 | PB3.0-P17652 | 51,90 |
| OS - Garnitur (ohne Schlüsselrosette) | PB3.0-1765OS | 41,90 | PB3.0-P1765OS | 47,90 |
| RZ - Garnitur | PB3.0-17658 | 45,90 | PB3.0-P17658 | 51,90 |
| WC - Garnitur | PB3.0-17653 | 55,90 | PB3.0-P17653 | 61,90 |
| WC - Garnitur rot/weiß Anz. | PB3.0-176531 | 59,90 | PB3.0-P176531 | 65,90 |
| WC - Garnitur rot/grün Anz. | PB3.0-176532 | 59,90 | PB3.0-P176532 | 65,90 |
| PZ-WG - Knopf ger. DIN R/L | PB3.0-17656/7 | 59,90 | PB3.0-P17656/7 | 65,90 |
| PZ-WG - Knopf gekr. DIN R/L | PB3.0-176561/71 | 63,90 | PB3.0-P176561/71 | 69,90 |
| Drückerpaar | | | | |
| ohne Rosetten | D17650 | 25,90 | D17650 | 25,90 |

Standard-Türstärken: 38 - 42 mm
 Aufpreis für Türstärken ab 42 mm: € 5,00

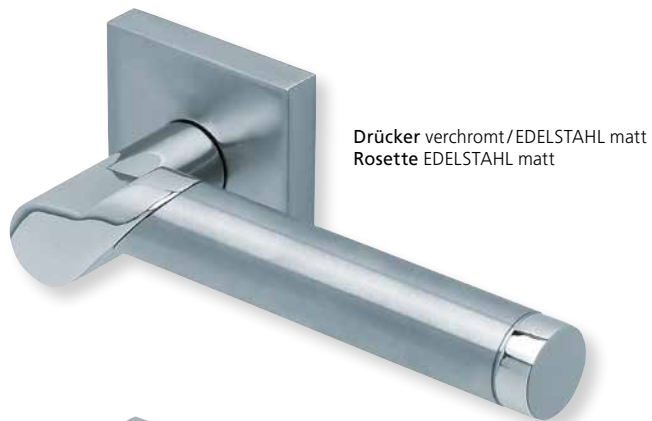

Drücker verchromt/EDELSTAHL matt
Rosette EDELSTAHL matt

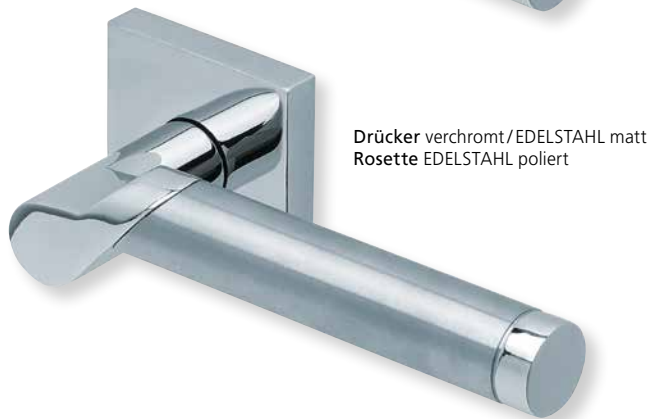

Drücker verchromt/EDELSTAHL matt
Rosette EDELSTAHL poliert

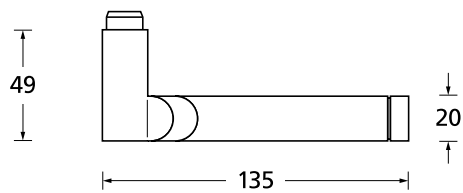



Pullbloc® 3.0 Kugellagertechnik



BB - Garnitur EDELSTAHL poliert



PZ - Garnitur EDELSTAHL poliert



WC - Garnitur EDELSTAHL poliert
WC - Garnitur rot/weiß Anzeige EDELSTAHL poliert
WC - Garnitur rot/grün Anzeige EDELSTAHL poliert



PZ - Wechselgarnitur Knopf gerade EDELSTAHL poliert



RZ - Garnitur EDELSTAHL poliert



PZ - Wechselgarnitur Knopf gekröpft EDELSTAHL poliert

Form 1765 auf Quadratrosette

| | Edelstahl matt | | Edelstahl poliert | |
|---------------------------------------|------------------|---------------|-------------------|---------------|
| | | € exkl. MwSt. | | € exkl. MwSt. |
| Rosettengarnitur | | | | |
| BB - Garnitur | PB3.0-Q17650 | 51,90 | PB3.0-QP17650 | 57,90 |
| PZ - Garnitur | PB3.0-Q17652 | 51,90 | PB3.0-QP17652 | 57,90 |
| OS - Garnitur (ohne Schlüsselrosette) | PB3.0-Q1765OS | 47,90 | PB3.0-QP1765OS | 53,90 |
| RZ - Garnitur | PB3.0-Q17658 | 51,90 | PB3.0-QP17658 | 57,90 |
| WC - Garnitur | PB3.0-Q17653 | 61,90 | PB3.0-QP17653 | 67,90 |
| WC - Garnitur rot/weiß Anz. | PB3.0-Q176531 | 65,90 | PB3.0-QP176531 | 71,90 |
| WC - Garnitur rot/grün Anz. | PB3.0-Q176532 | 65,90 | PB3.0-QP176532 | 71,90 |
| PZ-WG - Knopf ger. DIN R/L | PB3.0-Q17656/7 | 65,90 | PB3.0-QP17656/7 | 71,90 |
| PZ-WG - Knopf gekr. DIN R/L | PB3.0-Q176561/71 | 69,90 | PB3.0-QP176561/71 | 75,90 |
| Drückerpaar | | | | |
| ohne Rosetten | D17650 | 25,90 | D17650 | 25,90 |

Standard-Türstärken: 38 - 42 mm
Aufpreis für Türstärken ab 42 mm: € 5,00



In allen heimischen Holzarten lieferbar!

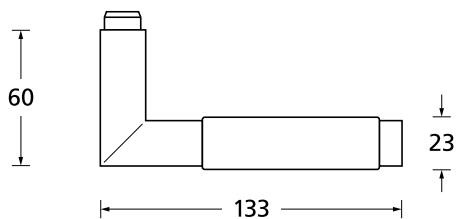



Pullbloc® 3.0 Kugellagertechnik

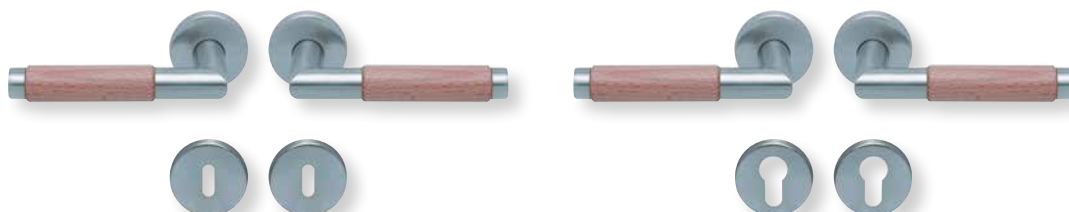

BB - Garnitur EDELSTAHL matt

PZ - Garnitur EDELSTAHL matt

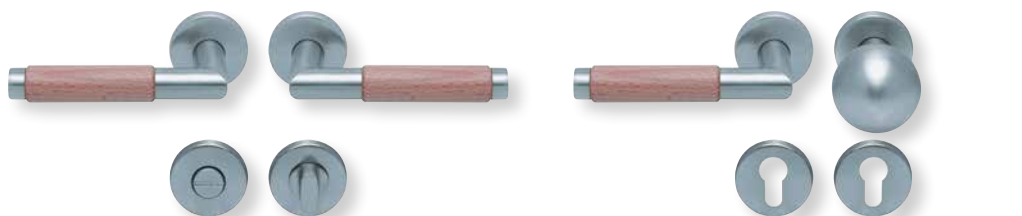

WC - Garnitur EDELSTAHL matt
 WC - Garnitur rot/weiß Anzeige EDELSTAHL matt
 WC - Garnitur rot/grün Anzeige EDELSTAHL matt

PZ - Wechselgarnitur Knopf gerade EDELSTAHL matt

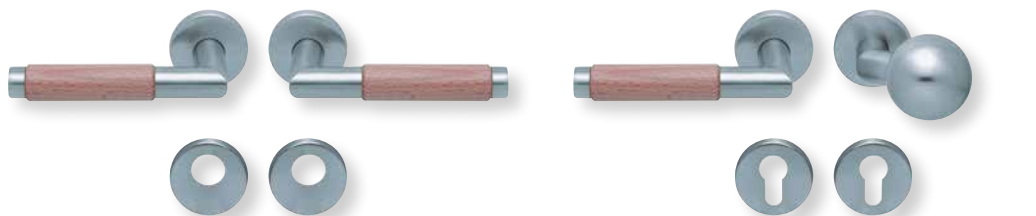

RZ - Garnitur EDELSTAHL matt

PZ - Wechselgarnitur Knopf gekröpft EDELSTAHL matt

Form 1X74 auf Rundrosette

Edelstahl matt

Rosettengarnitur

| | | € exkl. MwSt. |
|---------------------------------------|-----------------|---------------|
| BB - Garnitur | PB3.0-1X740 | 51,90 |
| PZ - Garnitur | PB3.0-1X742 | 51,90 |
| OS - Garnitur (ohne Schlüsselrosette) | PB3.0-1X740S | 47,90 |
| RZ - Garnitur | PB3.0-1X748 | 51,90 |
| WC - Garnitur | PB3.0-1X743 | 61,90 |
| WC - Garnitur rot/weiß Anz. | PB3.0-1X7431 | 65,90 |
| WC - Garnitur rot/grün Anz. | PB3.0-1X7432 | 65,90 |
| PZ-WG - Knopf ger. DIN R/L | PB3.0-1X746/7 | 65,90 |
| PZ-WG - Knopf gekr. DIN R/L | PB3.0-1X7461/71 | 69,90 |

Drückerpaar

| | | |
|---------------|--------|-------|
| ohne Rosetten | D1X740 | 29,90 |
|---------------|--------|-------|

Standard-Türstärken: 38 - 42 mm
 Aufpreis für Türstärken ab 42 mm: € 5,00



Drücker EDELSTAHL matt - Buche
Rosette EDELSTAHL matt

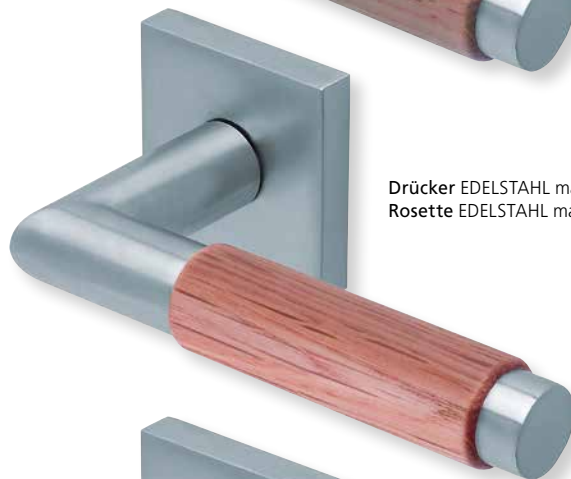

Drücker EDELSTAHL matt - Eiche
Rosette EDELSTAHL matt



Drücker EDELSTAHL matt - Merbau
Rosette EDELSTAHL matt

In allen heimischen Holzarten lieferbar!

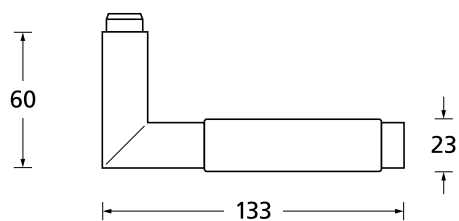



Pullbloc® 3.0 Kugellagertechnik

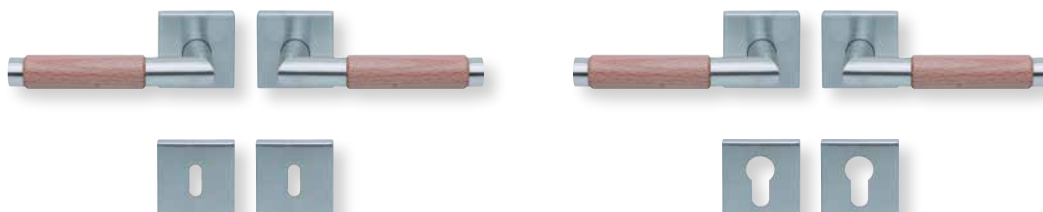

BB - Garnitur EDELSTAHL matt

PZ - Garnitur EDELSTAHL matt

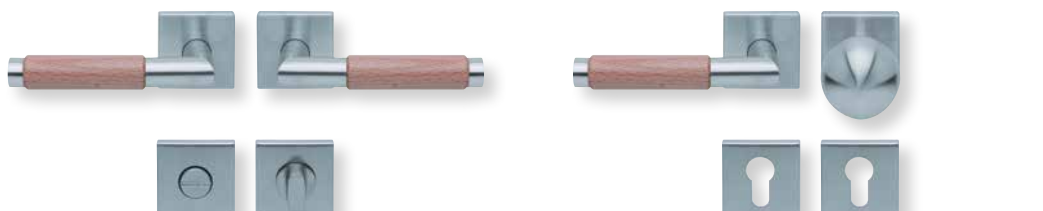

WC - Garnitur EDELSTAHL matt
WC - Garnitur rot/weiß Anzeige EDELSTAHL matt
WC - Garnitur rot/grün Anzeige EDELSTAHL matt

PZ - Wechselgarnitur Knopf gerade EDELSTAHL matt

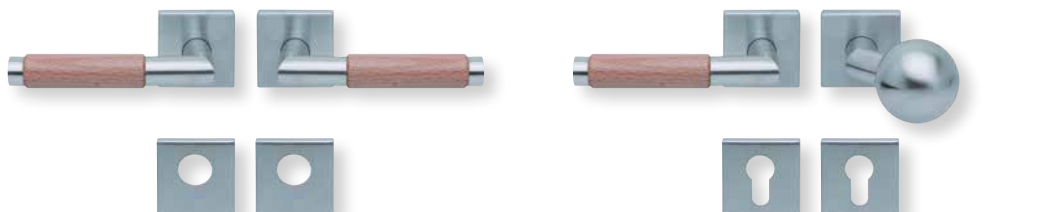

RZ - Garnitur EDELSTAHL matt

PZ - Wechselgarnitur Knopf gekröpft EDELSTAHL matt

Form 1X74 auf Quadratrosette

Edelstahl matt

Rosettengarnitur

| | | € exkl. MwSt. |
|---------------------------------------|------------------|---------------|
| BB - Garnitur | PB3.0-Q1X740 | 57,90 |
| PZ - Garnitur | PB3.0-Q1X742 | 57,90 |
| OS - Garnitur (ohne Schlüsselrosette) | PB3.0-Q1X740S | 53,90 |
| RZ - Garnitur | PB3.0-Q1X748 | 57,90 |
| WC - Garnitur | PB3.0-Q1X743 | 67,90 |
| WC - Garnitur rot/weiß Anz. | PB3.0-Q1X7431 | 71,90 |
| WC - Garnitur rot/grün Anz. | PB3.0-Q1X7432 | 71,90 |
| PZ-WG - Knopf ger. DIN R/L | PB3.0-Q1X746/7 | 71,90 |
| PZ-WG - Knopf gekr. DIN R/L | PB3.0-Q1X7461/71 | 75,90 |

Drückerpaar

| | | |
|---------------|--------|-------|
| ohne Rosetten | D1X740 | 29,90 |
|---------------|--------|-------|

Standard-Türstärken: 38 - 42 mm
Aufpreis für Türstärken ab 42 mm: € 5,00



Von Seite 200 bis Seite 211 finden Sie Türdrückergarnituren
zertifiziert nach **DIN 18273** für Feuerschutztüren und Rauchschutztüren.

| | | |
|---------------------------|----|----|
| Einleitung | ab | 4 |
| Kombinationsmöglichkeiten | ab | 20 |
| Schnellübersicht Formen | ab | 22 |
| Privat- und Objektbau GK3 | ab | 29 |

Feuerschutzgarnituren

| | | |
|--------------------------------|----|-----|
| Rosetten/Knöpfe/Schilder | ab | 213 |
| Glastürbeschläge | ab | 249 |
| Fenstergriffe | ab | 275 |
| Sicherheit | ab | 309 |
| Stoßgriffe | ab | 329 |
| Muschelgriffe | ab | 340 |
| Türstopper | ab | 345 |
| Türfixierer | ab | 347 |
| Hausnummern | ab | 348 |
| Buchstaben und Hinweisschilder | ab | 349 |



Drücker EDELSTAHL matt
Rosette EDELSTAHL matt



Drücker EDELSTAHL poliert
Rosette EDELSTAHL poliert

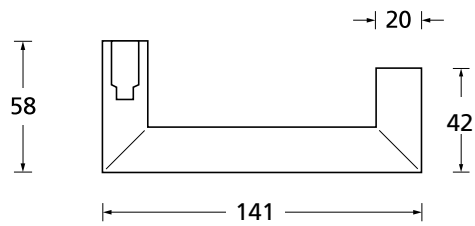



Pullbloc® 3.0 FS Kugellagertechnik DIN 18273 Feuerschutz



PZ - Garnitur EDELSTAHL matt



RZ - Garnitur EDELSTAHL matt



PZ - Wechselgarnitur Knopf gerade
EDELSTAHL matt



PZ - Wechselgarnitur Knopf gekröpft
EDELSTAHL matt

Form 1009 auf Rundrosette

| Feuerschutz DIN 18273 | Edelstahl matt | | Edelstahl poliert | |
|---------------------------------------|-------------------|---------------|--------------------|---------------|
| | | € exkl. MwSt. | | € exkl. MwSt. |
| PZ - Garnitur | PB3.0FS-10092 | 55,90 | PB3.0FS-P10092 | 65,90 |
| Blind - Garnitur | PB3.0FS-10091 | 55,90 | PB3.0FS-P10091 | 65,90 |
| OS - Garnitur (ohne Schlüsselrosette) | PB3.0FS-10090S | 51,90 | PB3.0FS-P10090S | 61,90 |
| RZ - Garnitur | PB3.0FS-10098 | 55,90 | PB3.0FS-P10098 | 65,90 |
| PZ-WG - Knopf ger. DIN R/L | PB3.0FS-10095/6 | 69,90 | PB3.0FS-P10095/6 | 79,90 |
| PZ-WG - Knopf gekr. DIN R/L | PB3.0FS-100951/61 | 73,90 | PB3.0FS-P100951/61 | 83,90 |
| Halbgarnitur für Treibriegel | PB3.0FS-80090S | 29,90 | PB3.0FS-P80090S | 35,90 |

Standard-Türstärken: 36 - 45 mm
Aufpreis für Türstärken ab 45 mm: € 5,90

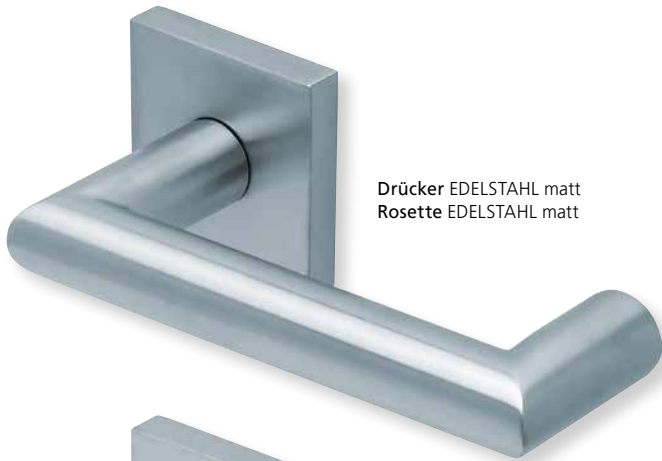

Drücker EDELSTAHL matt
Rosette EDELSTAHL matt



Drücker EDELSTAHL poliert
Rosette EDELSTAHL poliert

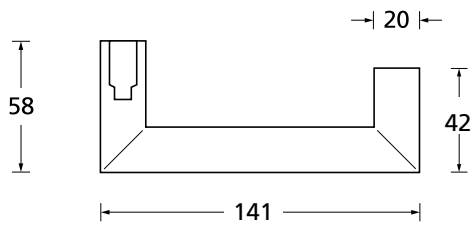



Pullbloc® 3.0 FS Kugellagertechnik DIN 18273 Feuerschutz



PZ - Garnitur EDELSTAHL poliert



RZ - Garnitur EDELSTAHL poliert



PZ - Wechselgarnitur Knopf gerade
EDELSTAHL poliert



PZ - Wechselgarnitur Knopf gekröpft
EDELSTAHL poliert

Form 1009 auf Quadratrosette

| Feuerschutz DIN 18273 | Edelstahl matt | | Edelstahl poliert | |
|---------------------------------------|--------------------|---------------|---------------------|---------------|
| | | € exkl. MwSt. | | € exkl. MwSt. |
| PZ - Garnitur | PB3.0FS-Q10092 | 61,90 | PB3.0FS-QP10092 | 71,90 |
| Blind - Garnitur | PB3.0FS-Q10091 | 61,90 | PB3.0FS-QP10091 | 71,90 |
| OS - Garnitur (ohne Schlüsselrosette) | PB3.0FS-Q1009OS | 57,90 | PB3.0FS-QP1009OS | 67,90 |
| RZ - Garnitur | PB3.0FS-Q10098 | 61,90 | PB3.0FS-QP10098 | 71,90 |
| PZ-WG - Knopf ger. DIN R/L | PB3.0FS-Q10095/6 | 66,90 | PB3.0FS-QP10095/6 | 76,90 |
| PZ-WG - Knopf gekr. DIN R/L | PB3.0FS-Q100951/61 | 69,90 | PB3.0FS-QP100951/61 | 79,90 |
| Halbgarnitur für Treibriegel | PB3.0FS-Q8009OS | 33,90 | PB3.0FS-QP8009OS | 39,90 |

Standard-Türstärken: 36 - 45 mm
Aufpreis für Türstärken ab 45 mm: € 5,90



Drücker EDELSTAHL matt
Rosette EDELSTAHL matt



Drücker EDELSTAHL poliert
Rosette EDELSTAHL poliert

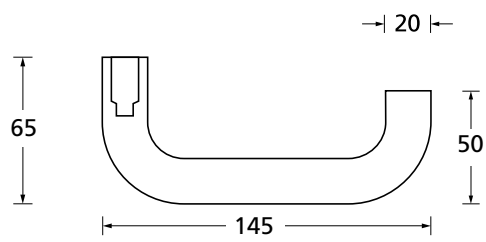



Pullbloc® 3.0 FS Kugellagertechnik DIN 18273 Feuerschutz



PZ - Garnitur EDELSTAHL matt



RZ - Garnitur EDELSTAHL matt



PZ - Wechselgarnitur Knopf gerade
EDELSTAHL matt



PZ - Wechselgarnitur Knopf gekröpft
EDELSTAHL matt

Form 1104 auf Rundrosette

| Feuerschutz DIN 18273 | Edelstahl matt | | Edelstahl poliert | |
|---------------------------------------|-------------------|---------------|--------------------|---------------|
| | | € exkl. MwSt. | | € exkl. MwSt. |
| PZ - Garnitur | PB3.0FS-11042 | 49,90 | PB3.0FS-P11042 | 59,90 |
| Blind - Garnitur | PB3.0FS-11041 | 49,90 | PB3.0FS-P11041 | 59,90 |
| OS - Garnitur (ohne Schlüsselrosette) | PB3.0FS-11040S | 45,90 | PB3.0FS-P11040S | 55,90 |
| RZ - Garnitur | PB3.0FS-11048 | 49,90 | PB3.0FS-P11048 | 59,90 |
| PZ-WG - Knopf ger. DIN R/L | PB3.0FS-11045/6 | 63,90 | PB3.0FS-P11045/6 | 73,90 |
| PZ-WG - Knopf gekr. DIN R/L | PB3.0FS-110451/61 | 67,90 | PB3.0FS-P110451/61 | 77,90 |
| Halbgarnitur für Treibriegel | PB3.0FS-81040S | 27,90 | PB3.0FS-P81040S | 33,90 |

Standard-Türstärken: 36 - 45 mm
Aufpreis für Türstärken ab 45 mm: € 5,90



Drücker EDELSTAHL matt
Rosette EDELSTAHL matt



Drücker EDELSTAHL poliert
Rosette EDELSTAHL poliert

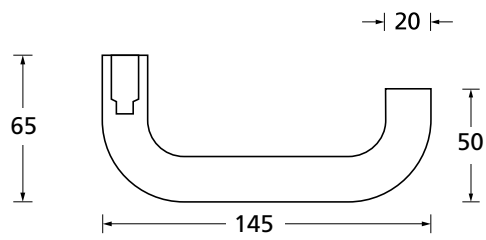



Pullbloc® 3.0 FS Kugellagertechnik DIN 18273 Feuerschutz



PZ - Garnitur EDELSTAHL poliert



RZ - Garnitur EDELSTAHL poliert



PZ - Wechselgarnitur Knopf gerade
EDELSTAHL poliert



PZ - Wechselgarnitur Knopf gekröpft
EDELSTAHL poliert

Form 1104 auf Quadratrosette

| Feuerschutz DIN 18273 | Edelstahl matt | | Edelstahl poliert | |
|---------------------------------------|--------------------|---------------|---------------------|---------------|
| | | € exkl. MwSt. | | € exkl. MwSt. |
| PZ - Garnitur | PB3.0FS-Q11042 | 55,90 | PB3.0FS-QP11042 | 65,90 |
| Blind - Garnitur | PB3.0FS-Q11041 | 55,90 | PB3.0FS-QP11041 | 65,90 |
| OS - Garnitur (ohne Schlüsselrosette) | PB3.0FS-Q11040S | 51,90 | PB3.0FS-QP11040S | 61,90 |
| RZ - Garnitur | PB3.0FS-Q11048 | 55,90 | PB3.0FS-QP11048 | 65,90 |
| PZ-WG - Knopf ger. DIN R/L | PB3.0FS-Q11045/6 | 69,90 | PB3.0FS-QP11045/6 | 79,90 |
| PZ-WG - Knopf gekr. DIN R/L | PB3.0FS-Q110451/61 | 73,90 | PB3.0FS-QP110451/61 | 83,90 |
| Halbgarnitur für Treibriegel | PB3.0FS-Q81040S | 31,90 | PB3.0FS-QP81040S | 35,90 |

Standard-Türstärken: 36 - 45 mm
Aufpreis für Türstärken ab 45 mm: € 5,90



Drücker EDELSTAHL matt
Rosette EDELSTAHL matt



Drücker EDELSTAHL poliert
Rosette EDELSTAHL poliert

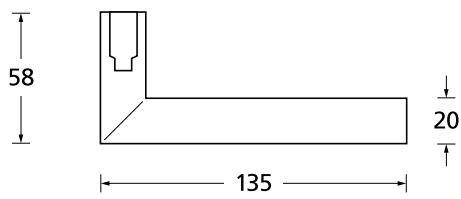



Pullbloc® 3.0 FS Kugellagertechnik DIN 18273 Feuerschutz



PZ - Garnitur EDELSTAHL matt



RZ - Garnitur EDELSTAHL matt



PZ - Wechselgarnitur Knopf gerade
EDELSTAHL matt



PZ - Wechselgarnitur Knopf gekröpft
EDELSTAHL matt

Form 1106 auf Rundrosette

| Feuerschutz DIN 18273 | Edelstahl matt | | Edelstahl poliert | |
|---------------------------------------|-------------------|---------------|--------------------|---------------|
| | | € exkl. MwSt. | | € exkl. MwSt. |
| PZ - Garnitur | PB3.0FS-11062 | 49,90 | PB3.0FS-P11062 | 59,90 |
| Blind - Garnitur | PB3.0FS-11061 | 49,90 | PB3.0FS-P11061 | 59,90 |
| OS - Garnitur (ohne Schlüsselrosette) | PB3.0FS-1106OS | 45,90 | PB3.0FS-P1106OS | 55,90 |
| RZ - Garnitur | PB3.0FS-11068 | 49,90 | PB3.0FS-P11068 | 59,90 |
| PZ-WG - Knopf ger. DIN R/L | PB3.0FS-11065/6 | 63,90 | PB3.0FS-P11065/6 | 73,90 |
| PZ-WG - Knopf gekr. DIN R/L | PB3.0FS-110651/61 | 67,90 | PB3.0FS-P110651/61 | 77,90 |
| Halbgarnitur für Treibriegel | PB3.0FS-8106OS | 27,90 | PB3.0FS-P8106OS | 33,90 |

Standard-Türstärken: 36 - 45 mm
Aufpreis für Türstärken ab 45 mm: € 5,90



Drücker EDELSTAHL matt
Rosette EDELSTAHL matt



Drücker EDELSTAHL poliert
Rosette EDELSTAHL poliert

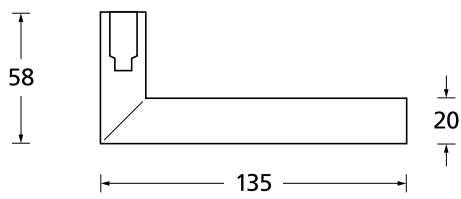



Pullbloc® 3.0 FS Kugellagertechnik DIN 18273 Feuerschutz



PZ - Garnitur EDELSTAHL poliert



RZ - Garnitur EDELSTAHL poliert



PZ - Wechselgarnitur Knopf gerade
EDELSTAHL poliert



PZ - Wechselgarnitur Knopf gekröpft
EDELSTAHL poliert

Form 1106 auf Quadratrosette

| Feuerschutz DIN 18273 | Edelstahl matt | | Edelstahl poliert | |
|---------------------------------------|--------------------|---------------|---------------------|---------------|
| | | € exkl. MwSt. | | € exkl. MwSt. |
| PZ - Garnitur | PB3.0FS-Q11062 | 55,90 | PB3.0FS-QP11062 | 65,90 |
| Blind - Garnitur | PB3.0FS-Q11061 | 55,90 | PB3.0FS-QP11061 | 65,90 |
| OS - Garnitur (ohne Schlüsselrosette) | PB3.0FS-Q11060S | 51,90 | PB3.0FS-QP11060S | 61,90 |
| RZ - Garnitur | PB3.0FS-Q11068 | 55,90 | PB3.0FS-QP11068 | 65,90 |
| PZ-WG - Knopf ger. DIN R/L | PB3.0FS-Q11065/6 | 69,90 | PB3.0FS-QP11065/6 | 79,90 |
| PZ-WG - Knopf gekr. DIN R/L | PB3.0FS-Q110651/61 | 73,90 | PB3.0FS-QP110651/61 | 83,90 |
| Halbgarnitur für Treibriegel | PB3.0FS-Q81060S | 31,90 | PB3.0FS-QP81060S | 35,90 |

Standard-Türstärken: 36 - 45 mm
Aufpreis für Türstärken ab 45 mm: € 5,90

| | | |
|---------------------------|----|-----|
| Einleitung | ab | 4 |
| Kombinationsmöglichkeiten | ab | 20 |
| Schnellübersicht Formen | ab | 22 |
| Privat- und Objektbau GK3 | ab | 29 |
| Feuerschutzgarnituren | ab | 199 |

Rosetten / Knöpfe / Schilder

| | | |
|--------------------------------|----|-----|
| Glastürbeschläge | ab | 249 |
| Fenstergriffe | ab | 275 |
| Sicherheit | ab | 309 |
| Stoßgriffe | ab | 329 |
| Muschelgriffe | ab | 340 |
| Türstopper | ab | 345 |
| Türfixierer | ab | 347 |
| Hausnummern | ab | 348 |
| Buchstaben und Hinweisschilder | ab | 349 |

Rundrosetten

Pullbloc® Kugellagertechnik

214



Rosette EDELSTAHL matt



Rosette EDELSTAHL poliert



Rosette PVD Messinggelb

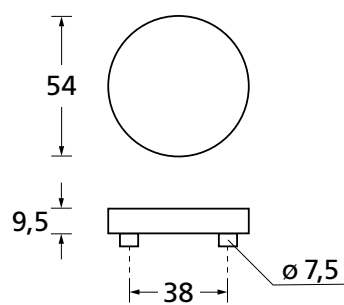



Drückerrosette
EDELSTAHL matt



BB - Rosette
EDELSTAHL matt



PZ - Rosette
EDELSTAHL matt



RZ - Rosette
EDELSTAHL matt



Blind - Rosette
EDELSTAHL matt



WC - Rosette
EDELSTAHL matt



WC - Rosette rot/weiß Anzeige EDELSTAHL matt
WC - Rosette rot/grün Anzeige EDELSTAHL matt

| | Edelstahl matt | | Edelstahl poliert | | PVD Messinggelb | |
|-----------------------------------|----------------|---------------|-------------------|---------------|-----------------|---------------|
| | | € exkl. MwSt. | | € exkl. MwSt. | | € exkl. MwSt. |
| Drückerrosette | | | | | | |
| Rosettenpaar | PB3.0-37002 | 19,80 | PB3.0-P37002 | 23,80 | PB3.0-PVM37002 | 27,80 |
| Drückerrosette Stk. | | | | | | |
| DIN R | PB3.0-37001 | 9,90 | PB3.0-P37001 | 11,90 | PB3.0-PVM37001 | 13,90 |
| DIN L | PB3.0-37000 | 9,90 | PB3.0-P37000 | 11,90 | PB3.0-PVM37000 | 13,90 |
| Schlüsselrosette | | | | | | |
| BB - Rosettenpaar | PB3.0-37006 | 11,40 | PB3.0-P37006 | 15,40 | PB3.0-PVM37006 | 19,40 |
| PZ - Rosettenpaar | PB3.0-37007 | 11,40 | PB3.0-P37007 | 15,40 | PB3.0-PVM37007 | 19,40 |
| RZ - Rosettenpaar | PB3.0-37008 | 11,40 | PB3.0-P37008 | 15,40 | PB3.0-PVM37008 | 19,40 |
| Blind - Rosettenpaar | PB3.0-37012 | 11,40 | PB3.0-P37012 | 15,40 | PB3.0-PVM37012 | 19,40 |
| WC - Rosetten inkl. Riegel | | | | | | |
| ohne Anzeige | PB3.0-27015 | 27,30 | PB3.0-P27015 | 31,30 | PB3.0-PVM27015 | 35,30 |
| rot/weiß Anzeige | PB3.0-27016 | 31,30 | PB3.0-P27016 | 35,30 | PB3.0-PVM27016 | 39,30 |
| rot/grün Anzeige | PB3.0-27017 | 31,30 | PB3.0-P27017 | 35,30 | PB3.0-PVM27017 | 39,30 |

Quadratrossetten

Pullbloc® Kugellagertechnik

216



Rosette EDELSTAHL matt



Rosette EDELSTAHL poliert



Rosette PVD Messinggelb

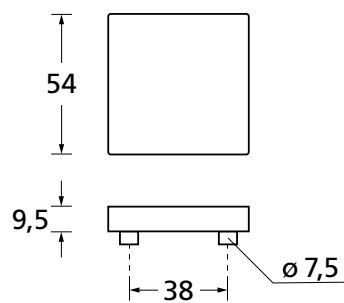



Drückerrosette
EDELSTAHL matt



BB - Rosette
EDELSTAHL matt



PZ - Rosette
EDELSTAHL matt



RZ - Rosette
EDELSTAHL matt



Blind - Rosette
EDELSTAHL matt



WC - Rosette
EDELSTAHL matt



WC - Rosette rot/weiß Anzeige EDELSTAHL matt
WC - Rosette rot/grün Anzeige EDELSTAHL matt

| | Edelstahl matt | | Edelstahl poliert | | PVD Messinggelb | |
|-----------------------------------|----------------|---------------|-------------------|---------------|-----------------|---------------|
| | | € exkl. MwSt. | | € exkl. MwSt. | | € exkl. MwSt. |
| Drückerrosette | | | | | | |
| Rosettenpaar | PB3.0-Q37002 | 27,80 | PB3.0-QP37002 | 31,80 | PB3.0-QPVM37002 | 35,80 |
| Drückerrosette Stk. | | | | | | |
| DIN R | PB3.0-Q37001 | 13,90 | PB3.0-QP37001 | 15,90 | PB3.0-QPVM37001 | 17,90 |
| DIN L | PB3.0-Q37000 | 13,90 | PB3.0-QP37000 | 15,90 | PB3.0-QPVM37000 | 17,90 |
| Schlüsselrosette | | | | | | |
| BB - Rosettenpaar | PB3.0-Q37006 | 19,40 | PB3.0-QP37006 | 23,40 | PB3.0-QPVM37006 | 27,40 |
| PZ - Rosettenpaar | PB3.0-Q37007 | 19,40 | PB3.0-QP37007 | 23,40 | PB3.0-QPVM37007 | 27,40 |
| RZ - Rosettenpaar | PB3.0-Q37008 | 19,40 | PB3.0-QP37008 | 23,40 | PB3.0-QPVM37008 | 27,40 |
| Blind - Rosettenpaar | PB3.0-Q37012 | 19,40 | PB3.0-QP37012 | 23,40 | PB3.0-QPVM37012 | 27,40 |
| WC - Rosetten inkl. Riegel | | | | | | |
| ohne Anzeige | PB3.0-Q27015 | 31,30 | PB3.0-QP27015 | 35,30 | PB3.0-QPVM27015 | 39,30 |
| rot/weiß Anzeige | PB3.0-Q27016 | 35,30 | PB3.0-QP27016 | 39,30 | PB3.0-QPVM27016 | 43,30 |
| rot/grün Anzeige | PB3.0-Q27017 | 35,30 | PB3.0-QP27017 | 39,30 | PB3.0-QPVM27017 | 43,30 |

Ovalrosetten

Pullbloc® Kugellagertechnik

218



Rosette EDELSTAHL matt



Rosette EDELSTAHL poliert

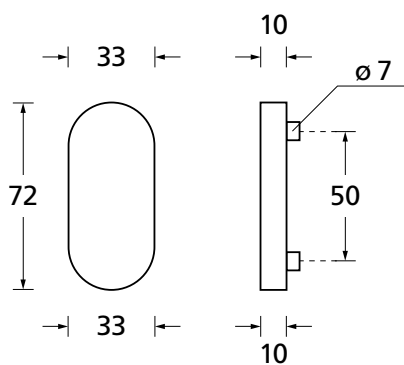

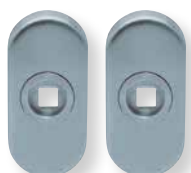

Drückerrosette
EDELSTAHL matt



PZ - Rosette
EDELSTAHL matt



Blind - Rosette
EDELSTAHL matt



WC - Rosette
EDELSTAHL matt

| | Edelstahl matt | | Edelstahl poliert | |
|-----------------------------------|----------------|---------------|-------------------|---------------|
| | | € exkl. MwSt. | | € exkl. MwSt. |
| Drückerrosette | | | | |
| durchgeschraubt Paar | PB57100 | 31,80 | PBP57100 | 35,80 |
| einseitig befestigt Stk. | PB57000 | 15,90 | PBP57000 | 17,90 |
| Schlüsselrosette PZ | | | | |
| durchgeschraubt Paar | PB57107 | 23,40 | PBP57107 | 27,40 |
| einseitig befestigt Stk. | PB57007 | 11,70 | PBP57007 | 13,70 |
| Schlüsselrosette Blind | | | | |
| durchgeschraubt Paar | PB57112 | 23,40 | PBP57112 | 27,40 |
| einseitig befestigt Stk. | PB57012 | 11,70 | PBP57012 | 13,70 |
| WC - Rosetten inkl. Riegel | | | | |
| durchgeschraubt Paar | PB57115 | 39,90 | PBP57115 | 43,90 |
| einseitig befestigt Paar | PB57015 | 39,90 | PBP57015 | 43,90 |

Rosetten eckig

Pullbloc® Kugellagertechnik

220



Rosette EDELSTAHL matt



Rosette EDELSTAHL poliert

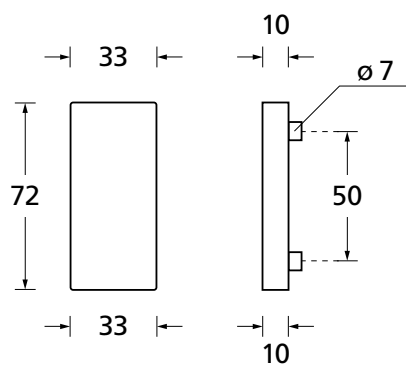



Drückerrosette
EDELSTAHL matt



PZ - Rosette
EDELSTAHL matt



Blind - Rosette
EDELSTAHL matt

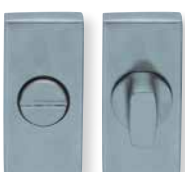

WC - Rosette
EDELSTAHL matt

| | Edelstahl matt | | Edelstahl poliert | |
|-----------------------------------|----------------|---------------|-------------------|---------------|
| | | € exkl. MwSt. | | € exkl. MwSt. |
| Drückerrosette | | | | |
| durchgeschraubt Paar | PBE57100 | 39,80 | PBEP57100 | 43,80 |
| einseitig befestigt Stk. | PBE57000 | 19,90 | PBEP57000 | 21,90 |
| Schlüsselrosette PZ | | | | |
| durchgeschraubt Paar | PBE57107 | 31,40 | PBEP57107 | 35,40 |
| einseitig befestigt Stk. | PBE57007 | 15,70 | PBEP57007 | 17,70 |
| Schlüsselrosette Blind | | | | |
| durchgeschraubt Paar | PBE57112 | 31,40 | PBEP57112 | 35,40 |
| einseitig befestigt Stk. | PBE57012 | 15,70 | PBEP57012 | 17,70 |
| WC - Rosetten inkl. Riegel | | | | |
| durchgeschraubt Paar | PBE57115 | 43,90 | PBEP57115 | 47,90 |
| einseitig befestigt Paar | PBE57015 | 43,90 | PBEP57015 | 47,90 |

Die Schnellmontage

Flächenbündige Optik und Quadratrosetten flach

222

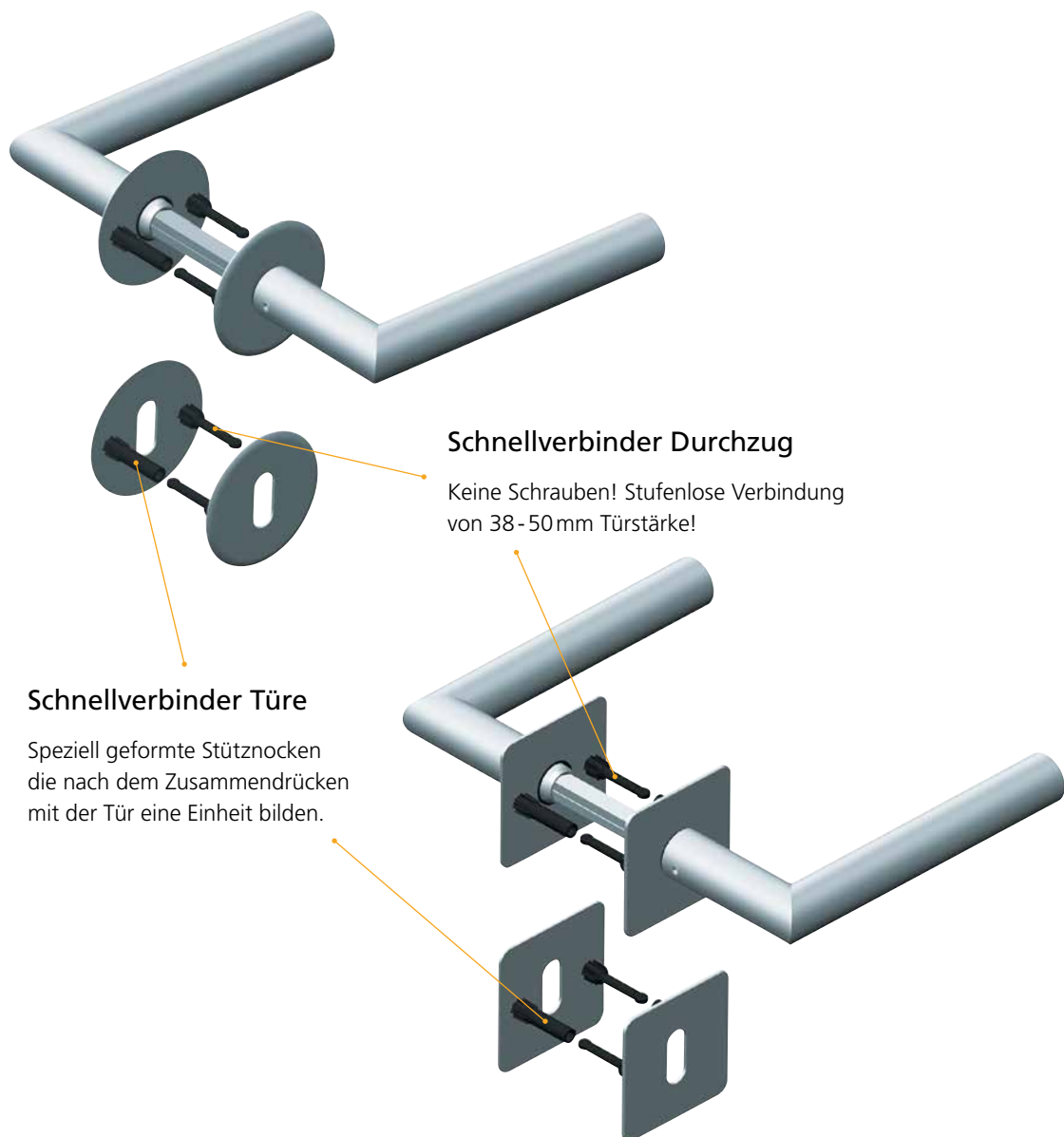



Flächenbündige Optik ohne fräsen, ohne schrauben!



Ausführung: WC



Ausführung: PZ

Flächenbündige Optik Rundrosetten

224



Rosette EDELSTAHL matt

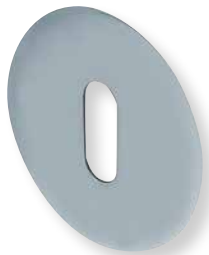

Rosette EDELSTAHL poliert



Rosette PVD Messinggelb

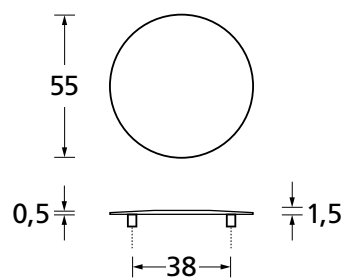

Rundrosetten mit flächenbündiger Optik sind mit allen Türdrückerformen kombinierbar. Rosettengarnituren preisgleich wie **Pullbloc® 3.0**.



Drückerrosette
EDELSTAHL matt



BB - Rosette
EDELSTAHL matt



PZ - Rosette
EDELSTAHL matt



RZ - Rosette
EDELSTAHL matt



Blind - Rosette
EDELSTAHL matt



WC - Rosette
EDELSTAHL matt

| | Edelstahl matt | | Edelstahl poliert | | PVD Messinggelb | |
|-------------------------|----------------|---------------|-------------------|---------------|-----------------|---------------|
| | | € exkl. MwSt. | | € exkl. MwSt. | | € exkl. MwSt. |
| Drückerrosette | | | | | | |
| Rosettenpaar | F57002 | 25,90 | FP57002 | 29,90 | FPVM57002 | 33,90 |
| Schlüsselrosette | | | | | | |
| BB - Rosettenpaar | F57006 | 25,90 | FP57006 | 29,90 | FPVM57006 | 33,90 |
| PZ - Rosettenpaar | F57007 | 25,90 | FP57007 | 29,90 | FPVM57007 | 33,90 |
| RZ - Rosettenpaar | F57008 | 25,90 | FP57008 | 29,90 | FPVM57008 | 33,90 |
| Blind - Rosettenpaar | F57012 | 25,90 | FP57012 | 29,90 | FPVM57012 | 33,90 |
| WC - Rosetten | | | | | | |
| inkl. WC-Riegel | F57015 | 29,30 | FP57015 | 33,30 | FPVM57015 | 37,30 |

Quadratrossetten flach mit Schnellmontage

226



Rosette EDELSTAHL matt



Rosette EDELSTAHL poliert



Rosette PVD Messinggelb

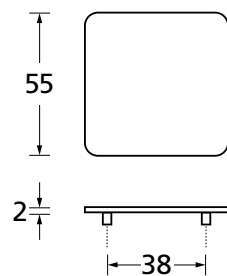

Quadratrossetten flach sind mit allen Türdrückerformen kombinierbar. Rosettengarnituren preisgleich **wie Pullbloc® 3.0.**



Drückerrosette
EDELSTAHL matt



BB - Rosette
EDELSTAHL matt



PZ - Rosette
EDELSTAHL matt



RZ - Rosette
EDELSTAHL matt



Blind - Rosette
EDELSTAHL matt



WC - Rosette
EDELSTAHL matt

| | Edelstahl matt | Edelstahl poliert | PVD Messinggelb |
|-------------------------|----------------|-------------------|------------------|
| | € exkl. MwSt. | € exkl. MwSt. | € exkl. MwSt. |
| Drückerrosette | | | |
| Rosettenpaar | FQ57002 33,90 | FQP57002 37,90 | FQPVM57002 41,90 |
| Schlüsselrosette | | | |
| BB - Rosettenpaar | FQ57006 33,90 | FQP57006 37,90 | FQPVM57006 41,90 |
| PZ - Rosettenpaar | FQ57007 33,90 | FQP57007 37,90 | FQPVM57007 41,90 |
| RZ - Rosettenpaar | FQ57008 33,90 | FQP57008 37,90 | FQPVM57008 41,90 |
| Blind - Rosettenpaar | FQ57012 33,90 | FQP57012 37,90 | FQPVM57012 41,90 |
| WC - Rosetten | | | |
| inkl. WC-Riegel | FQ57015 37,30 | FQP57015 41,30 | FQPVM57015 45,30 |

Kugelknopf auf Rundrosette



Kugelknopf gerade
EDELSTAHL matt



Kugelknopf gekröpft
EDELSTAHL matt



Kugelknopf gerade
EDELSTAHL poliert



Kugelknopf gekröpft
EDELSTAHL poliert



Kugelknopf gerade
PVD Messinggelb



Kugelknopf gekröpft
PVD Messinggelb

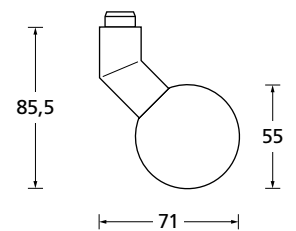
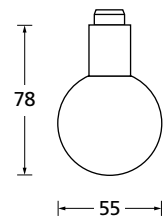

| | Edelstahl matt | | Edelstahl poliert | | PVD Messinggelb | |
|----------------------------------|----------------|-------|-------------------|-------|------------------|-------|
| | € exkl. MwSt. | | € exkl. MwSt. | | € exkl. MwSt. | |
| Knopf für Wechselgarnitur | | | | | | |
| inkl. PZ-Rosette | | | | | | |
| Knopf gerade | 77101 | 30,60 | P77101 | 34,60 | PVM77101 | 38,60 |
| Knopf gekröpft | 78101 | 34,60 | P78101 | 38,60 | PVM78101 | 42,60 |
| Knopf drehbar | | | | | | |
| ohne Schlüsselrosette | | | | | | |
| Knopf gerade DIN R/L | PB3.0-16180/1 | 30,60 | PB3.0-P16180/1 | 34,60 | PB3.0-PVM16180/1 | 38,60 |
| Knopf gekröpft DIN R/L | PB3.0-16182/3 | 34,60 | PB3.0-P16182/3 | 38,60 | PB3.0-PVM16182/3 | 42,60 |
| Knopf einseitig fix | | | | | | |
| ohne Schlüsselrosette | | | | | | |
| Knopf gerade | 69100 | 30,60 | P69100 | 34,60 | PVM69100 | 38,60 |
| Knopf gekröpft | 69101 | 34,60 | P69101 | 38,60 | PVM69101 | 42,60 |



Kugelknopf auf Quadratrosette



Kugelknopf gerade
EDELSTAHL matt



Kugelknopf gekröpft
EDELSTAHL matt



Kugelknopf gerade
EDELSTAHL poliert



Kugelknopf gekröpft
EDELSTAHL poliert



Kugelknopf gerade
PVD Messinggelb



Kugelknopf gekröpft
PVD Messinggelb

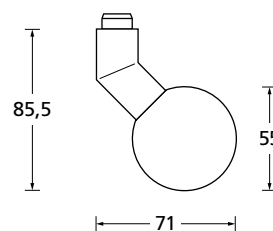
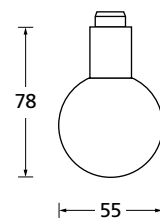

| | Edelstahl matt | | Edelstahl poliert | | PVD Messinggelb | |
|----------------------------------|----------------|-------|-------------------|-------|-------------------|-------|
| | € exkl. MwSt. | | € exkl. MwSt. | | € exkl. MwSt. | |
| Knopf für Wechselgarnitur | | | | | | |
| inkl. PZ-Rosette | | | | | | |
| Knopf gerade | Q77101 | 36,60 | QP77101 | 40,60 | QPVM77101 | 44,60 |
| Knopf gekröpft | Q78101 | 40,60 | QP78101 | 44,60 | QPVM78101 | 48,60 |
| Knopf drehbar | | | | | | |
| ohne Schlüsselrosette | | | | | | |
| Knopf gerade DIN R/L | PB3.0-Q16180/1 | 36,60 | PB3.0-QP16180/1 | 40,60 | PB3.0-QPVM16180/1 | 44,60 |
| Knopf gekröpft DIN R/L | PB3.0-Q16182/3 | 40,60 | PB3.0-QP16182/3 | 40,60 | PB3.0-QPVM16182/3 | 48,60 |
| Knopf einseitig fix | | | | | | |
| ohne Schlüsselrosette | | | | | | |
| Knopf gerade | Q69100 | 36,60 | QP69100 | 40,60 | QPVM69100 | 44,60 |
| Knopf gekröpft | Q69101 | 40,60 | QP69101 | 44,60 | QPVM69101 | 48,60 |

Zylindrischer Knopf auf Rundrosette



Zylindrischer Knopf gerade
EDELSTAHL matt



Zylindrischer Knopf versetzt
EDELSTAHL matt



Zylindrischer Knopf gerade
EDELSTAHL poliert



Zylindrischer Knopf versetzt
EDELSTAHL poliert

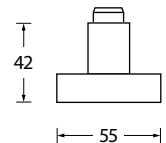

Zylindrischer Knopf gerade
PVD Messinggelb



Zylindrischer Knopf versetzt
PVD Messinggelb

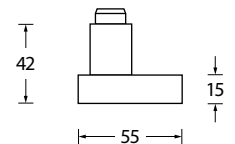

| | Edelstahl matt | | Edelstahl poliert | | PVD Messinggelb | |
|----------------------------------|----------------|-------|-------------------|-------|------------------|-------|
| | € exkl. MwSt. | | € exkl. MwSt. | | € exkl. MwSt. | |
| Knopf für Wechselgarnitur | | | | | | |
| inkl. PZ-Rosette | | | | | | |
| Knopf gerade | 72101 | 30,60 | P27101 | 34,60 | PVM72101 | 38,60 |
| Knopf versetzt | 76201 | 34,60 | P76201 | 38,60 | PVM76201 | 42,60 |
| Knopf drehbar | | | | | | |
| ohne Schlüsselrosette | | | | | | |
| Knopf gerade DIN R/L | PB3.0-16084/5 | 30,60 | PB3.0-P16084/5 | 34,60 | PB3.0-PVM16084/5 | 38,60 |
| Knopf versetzt DIN R/L | PB3.0-16086/7 | 34,60 | PB3.0-P16086/7 | 38,60 | PB3.0-PVM16086/7 | 42,60 |
| Knopf einseitig fix | | | | | | |
| ohne Schlüsselrosette | | | | | | |
| Knopf gerade | 691002 | 30,60 | P691002 | 34,60 | PVM691002 | 38,60 |
| Knopf versetzt | 691012 | 34,60 | P691012 | 38,60 | PVM691012 | 42,60 |



Zylindrischer Knopf auf Quadratrosette



Zylindrischer Knopf gerade
EDELSTAHL matt



Zylindrischer Knopf versetzt
EDELSTAHL matt



Zylindrischer Knopf gerade
EDELSTAHL poliert



Zylindrischer Knopf versetzt
EDELSTAHL poliert

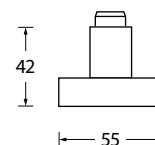

Zylindrischer Knopf gerade
PVD Messinggelb



Zylindrischer Knopf versetzt
PVD Messinggelb

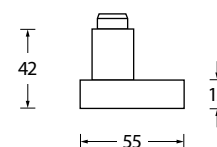

| | Edelstahl matt | | Edelstahl poliert | | PVD Messinggelb | |
|----------------------------------|----------------|-------|-------------------|-------|-------------------|-------|
| | € exkl. MwSt. | | € exkl. MwSt. | | € exkl. MwSt. | |
| Knopf für Wechselgarnitur | | | | | | |
| inkl. PZ-Rosette | | | | | | |
| Knopf gerade | Q72101 | 36,60 | QP72101 | 40,60 | QPVM72101 | 44,60 |
| Knopf versetzt | Q76201 | 40,60 | QP76201 | 44,60 | QPVM76201 | 48,60 |
| Knopf drehbar | | | | | | |
| ohne Schlüsselrosette | | | | | | |
| Knopf gerade DIN R/L | PB3.0-Q16084/5 | 36,60 | PB3.0-QP16084/5 | 40,60 | PB3.0-QPVM16084/5 | 44,60 |
| Knopf versetzt DIN R/L | PB3.0-Q16086/7 | 40,60 | PB3.0-QP16086/7 | 40,60 | PB3.0-QPVM16086/7 | 48,60 |
| Knopf einseitig fix | | | | | | |
| ohne Schlüsselrosette | | | | | | |
| Knopf gerade | Q691002 | 36,60 | QP691002 | 40,60 | QPVM691002 | 44,60 |
| Knopf versetzt | Q691012 | 40,60 | QP691012 | 44,60 | QPVM691012 | 48,60 |

Kugelknopf auf Ovalrosette

232



Kugelknopf gekröpft
EDELSTAHL matt



Kugelknopf gekröpft
EDELSTAHL poliert

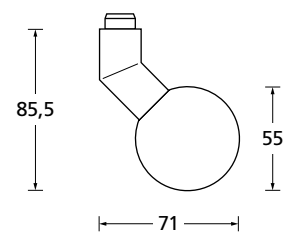

| | Edelstahl matt | | Edelstahl poliert | |
|----------------------------------|----------------|-------|-------------------|-------|
| | € exkl. MwSt. | | € exkl. MwSt. | |
| Knopf für Wechselgarnitur | | | | |
| inkl. PZ-Rosette | | | | |
| Knopf versetzt | 65102 | 34,60 | P65101 | 38,60 |
| Knopf drehbar | | | | |
| ohne Schlüsselrosette | | | | |
| Knopf versetzt | PB16192 | 34,60 | PBP16192 | 38,60 |



Kugelknopf auf eckiger Rosette



Kugelknopf gekröpft
EDELSTAHL matt



Kugelknopf gekröpft
EDELSTAHL poliert

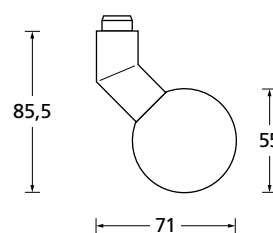

| | Edelstahl matt | Edelstahl poliert |
|----------------------------------|---------------------|---------------------|
| Knopf für Wechselgarnitur | _____ € exkl. MwSt. | _____ € exkl. MwSt. |
| inkl. PZ-Rosette | | |
| Knopf versetzt | E65101 40,60 | EP65101 44,60 |
| Knopf drehbar | _____ | _____ |
| ohne Schlüsselrosette | | |
| Knopf versetzt | EPB16192 40,60 | PBEP16192 44,60 |

Montageplatte mit Wechselstift für Halbgarnituren



Montageplatte mit Klemmwechselstift 8 mm

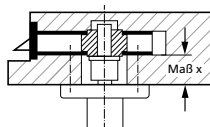

Set mit Stiftlänge 58 mm € exkl. MwSt.
Maß x: 9-19 mm 00140Set 21,90

Set mit Stiftlänge 68 mm € exkl. MwSt.
Maß x: 19-29 mm 00141Set 21,90



Montageplatte mit Klemmwechselstift 8/10 mm

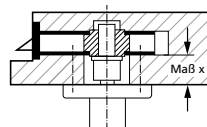

Set mit Stiftlänge 68 mm € exkl. MwSt.
Maß x: 19-29 mm 00144Set 25,90

Set mit Stiftlänge 78 mm € exkl. MwSt.
Maß x: 29-39 mm 00145Set 25,90

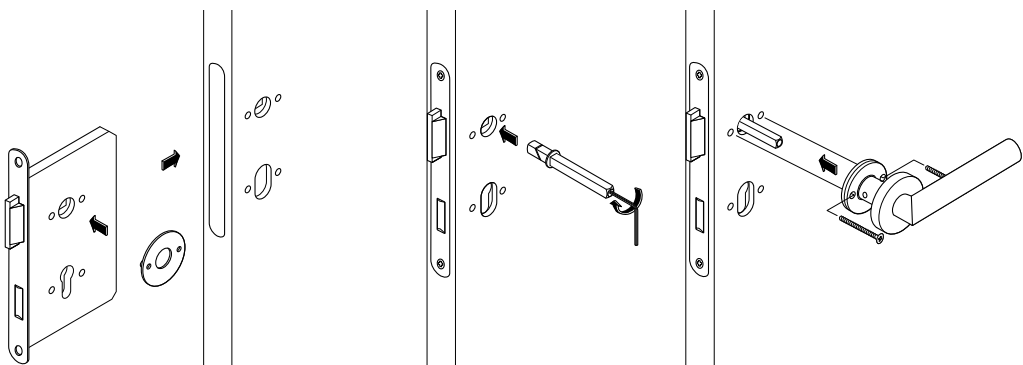



Riegel für Sperrbügel

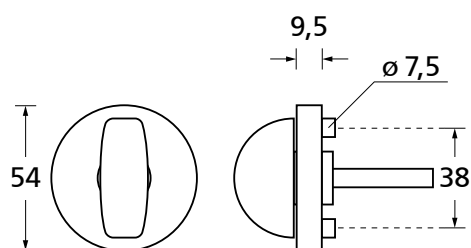

| Riegel für Sperrbügel | | € exkl. MwSt. |
|------------------------------|-----------|---------------|
| Stiftlänge: 32/32 mm | SB87015-1 | 29,90 |
| Stiftlänge: 32/34 mm | SB87015 | 29,90 |

Langschilder

Pullbloc® Kugellagertechnik

236



Langschild
EDELSTAHL matt



Langschild
EDELSTAHL poliert

Langschilder sind kombinierbar mit allen Türdrückerformen.



Langschild schmal
EDELSTAHL matt



Langschild schmal
EDELSTAHL poliert

Langschilder schmal sind kombinierbar mit allen Türdrückerformen.

Langschilder

Pullbloc® Kugellagertechnik

238



Langschild
EDELSTAHL matt



Langschild
EDELSTAHL poliert

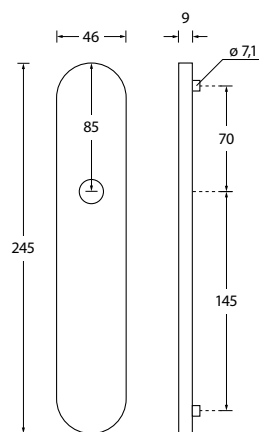
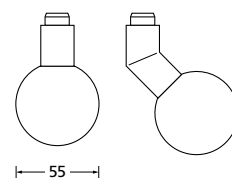

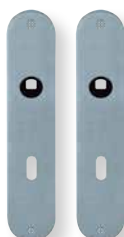

BB - Garnitur EDELSTAHL matt



PZ - Garnitur EDELSTAHL matt



WC - Garnitur EDELSTAHL matt



WC - Garnitur rot/weiß Anzeige EDELSTAHL matt
WC - Garnitur rot/grün Anzeige EDELSTAHL matt



PZ - Wechselgarnitur Knopf gerade
EDELSTAHL matt



PZ - Wechselgarnitur Knopf gekröpft
EDELSTAHL matt

| | Edelstahl matt | | Edelstahl poliert | |
|-----------------------------------|----------------|---------------|-------------------|---------------|
| | | € exkl. MwSt. | | € exkl. MwSt. |
| Langschild | | | | |
| BB - Garnitur | PB27026 | 59,90 | PBP27026 | 63,90 |
| PZ - Garnitur | PB27027 | 59,90 | PBP27027 | 63,90 |
| Blind | PB27021 | 59,90 | PBP27021 | 63,90 |
| WC - Garnitur inkl. Riegel | | | | |
| ohne Anzeige | PB27025 | 71,90 | PBP27025 | 75,90 |
| rot/weiß Anz. | PB270251 | 87,90 | PBP270251 | 91,90 |
| rot/grün Anz. | PB270252 | 87,90 | PBP270252 | 91,90 |
| Wechselgarnitur | | | | |
| PZ-WG - Knopf ger. | 67201 | 71,90 | P67201 | 75,90 |
| PZ-WG - Knopf gekr. | 67202 | 75,90 | P67202 | 79,90 |
| Wechselgarnitur | | | | |
| Knopf drehbar | | | | |
| PZ-WG - Knopf ger. | PB16184 | 75,90 | PBP16184 | 79,90 |
| PZ-WG - Knopf gekr. | PB16185 | 79,90 | PBP16185 | 83,90 |

Langschilder schmal

Pullbloc® Kugellagertechnik

240



Langschild schmal
EDELSTAHL matt



Langschild schmal
EDELSTAHL poliert

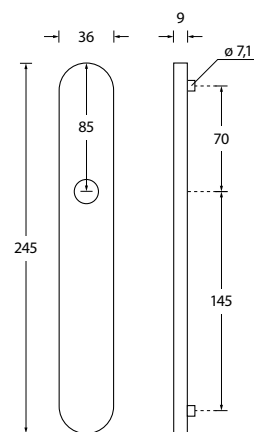
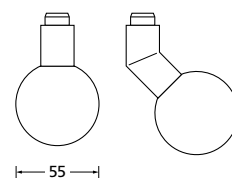



BB - Garnitur EDELSTAHL matt



PZ - Garnitur EDELSTAHL matt



WC - Garnitur EDELSTAHL matt



WC - Garnitur rot/weiß Anzeige EDELSTAHL matt
WC - Garnitur rot/grün Anzeige EDELSTAHL matt



PZ - Wechselgarnitur Knopf gerade
EDELSTAHL matt



PZ - Wechselgarnitur Knopf gekröpft
EDELSTAHL matt

| | Edelstahl matt | | Edelstahl poliert | |
|-----------------------------------|----------------|---------------|-------------------|---------------|
| | | € exkl. MwSt. | | € exkl. MwSt. |
| Langschild | | | | |
| BB - Garnitur | PB27056 | 59,90 | PBP27056 | 63,90 |
| PZ - Garnitur | PB27059 | 59,90 | PBP27059 | 63,90 |
| Blind | PB27051 | 59,90 | PBP27051 | 63,90 |
| WC - Garnitur inkl. Riegel | | | | |
| ohne Anzeige | PB27055 | 71,90 | PBP27055 | 75,90 |
| rot/weiß Anz. | PB270551 | 87,90 | PBP270551 | 91,90 |
| rot/grün Anz. | PB270552 | 87,90 | PBP270552 | 91,90 |
| Wechselgarnitur | | | | |
| PZ-WG - Knopf ger. | 61201 | 71,90 | P62201 | 75,30 |
| PZ-WG - Knopf gekr. | 62202 | 75,90 | P62202 | 79,90 |
| Wechselgarnitur | | | | |
| Knopf drehbar | | | | |
| PZ-WG - Knopf ger. | PB16194 | 75,90 | PBP16194 | 79,90 |
| PZ-WG - Knopf gekr. | PB16195 | 79,90 | PBP16195 | 83,90 |

Kurzschilder

Pullbloc® Kugellagertechnik

242



Kurzschild
EDELSTAHL matt



Kurzschild
EDELSTAHL poliert

Kurzschilder sind kombinierbar mit allen Türdrückerformen.



Kurzschild schmal
EDELSTAHL matt



Kurzschild schmal
EDELSTAHL poliert

Kurzschilder schmal sind kombinierbar mit allen Türdrückerformen.

Kurzschilder

Pullbloc® Kugellagertechnik

244



Kurzschild
EDELSTAHL matt



Kurzschild
EDELSTAHL poliert

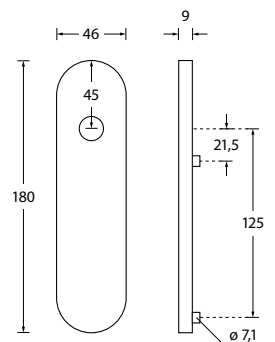
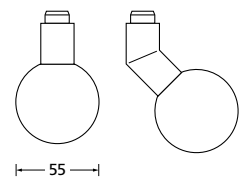

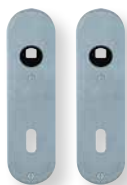

BB - Garnitur EDELSTAHL matt



PZ - Garnitur EDELSTAHL matt



WC - Garnitur EDELSTAHL matt



WC - Garnitur rot/weiß Anzeige EDELSTAHL matt
WC - Garnitur rot/grün Anzeige EDELSTAHL matt



PZ - Wechselgarnitur Knopf gerade
EDELSTAHL matt



PZ - Wechselgarnitur Knopf gekröpft
EDELSTAHL matt

| | Edelstahl matt | | Edelstahl poliert | |
|--------------------------------------|----------------|---------------|-------------------|---------------|
| | | € exkl. MwSt. | | € exkl. MwSt. |
| Langschild | | | | |
| BB - Garnitur | PB27036 | 55,90 | PBP27036 | 59,90 |
| PZ - Garnitur | PB27039 | 55,90 | PBP27039 | 59,90 |
| Blind | PB27031 | 55,90 | PBP27031 | 59,90 |
| WC - Garnitur inkl. Riegel | | | | |
| ohne Anzeige | PB27035 | 67,90 | PBP27035 | 71,90 |
| rot/weiß Anz. | PB270351 | 83,90 | PBP270351 | 87,90 |
| rot/grün Anz. | PB270352 | 63,90 | PBP270352 | 87,90 |
| Wechselgarnitur | | | | |
| PZ-WG - Knopf ger. | 67301 | 67,90 | P67301 | 71,90 |
| PZ-WG - Knopf gekr. | 67302 | 71,90 | P67302 | 75,90 |
| Wechselgarnitur Knopf drehbar | | | | |
| PZ-WG - Knopf ger. | PB16186 | 71,90 | PBP16186 | 75,90 |
| PZ-WG - Knopf gekr. | PB16185 | 75,90 | PBP16187 | 79,90 |

Kurzschilder schmal

Pullbloc® Kugellagertechnik

246



Kurzschild schmal
EDELSTAHL matt



Kurzschild schmal
EDELSTAHL poliert

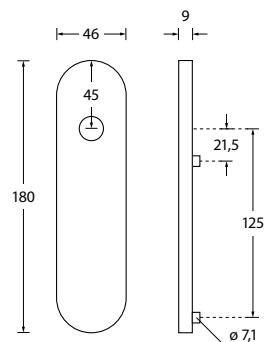
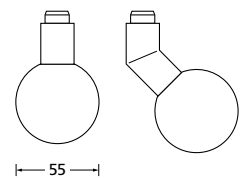



BB - Garnitur EDELSTAHL matt



PZ - Garnitur EDELSTAHL matt



WC - Garnitur EDELSTAHL matt



WC - Garnitur rot/weiß Anzeige EDELSTAHL matt
WC - Garnitur rot/grün Anzeige EDELSTAHL matt



PZ - Wechselgarnitur Knopf gerade
EDELSTAHL matt



PZ - Wechselgarnitur Knopf gekröpft
EDELSTAHL matt

| | Edelstahl matt | | Edelstahl poliert | |
|-----------------------------------|----------------|---------------|-------------------|---------------|
| | | € exkl. MwSt. | | € exkl. MwSt. |
| Langschild | | | | |
| BB - Garnitur | PB27066 | 55,90 | PBP27066 | 59,90 |
| PZ - Garnitur | PB27069 | 55,90 | PBP27069 | 59,90 |
| Blind | PB27061 | 55,90 | PBP27061 | 59,90 |
| WC - Garnitur inkl. Riegel | | | | |
| ohne Anzeige | PB27065 | 67,90 | PBP27065 | 71,90 |
| rot/weiß Anz. | PB270651 | 83,90 | PBP270651 | 87,90 |
| rot/grün Anz. | PB270652 | 63,90 | PBP270652 | 87,90 |
| Wechselgarnitur | | | | |
| PZ-WG - Knopf ger. | 62301 | 67,90 | P62301 | 71,90 |
| PZ-WG - Knopf gekr. | 61302 | 71,90 | P62302 | 75,90 |
| Wechselgarnitur | | | | |
| Knopf drehbar | | | | |
| PZ-WG - Knopf ger. | PB16196 | 71,90 | PBP16196 | 75,90 |
| PZ-WG - Knopf gekr. | PB16195 | 75,90 | PBP16197 | 79,90 |

Standard-Türstärken: 36 - 45 mm

Von Seite 250 bis Seite 255 finden Sie Glastürschlösser zertifiziert nach **DIN EN 12209** laut folgendem Schlüssel.

| Gebrauchskategorie | Dauerfunktionstüchtigkeit und Belastung der Falle | Türmasse und Schließkraft | Eignung für Verwendung an Feuer-/Rauchschutztüren | Sicherheit | Korrosionsbeständigkeit und Temperatur | Schutzwirkung und Anbohrwiderstand |
|--------------------|---------------------------------------------------|---------------------------|---------------------------------------------------|------------|----------------------------------------|------------------------------------|
| 3 | M | 5 | 0 | 0 | F | 0 |

| Türbezogener Verwendungsbe- reich | Art der Schlüsselbe- tätigung und Verriegelung | Art der Spindel- betätigung | Schlüssel- kennung |
|--------------------------------------|---------------------------------------------------|--------------------------------|-----------------------|
| E | A/D/0 | 2 | 0 |

| | | |
|---------------------------|----|-----|
| Einleitung | ab | 4 |
| Kombinationsmöglichkeiten | ab | 20 |
| Schnellübersicht Formen | ab | 22 |
| Privat- und Objektbau GK3 | ab | 29 |
| Feuerschutzgarnituren | ab | 199 |
| Rosetten/Knöpfe/Schilder | ab | 213 |

Glastürbeschläge

| | | |
|--------------------------------|----|-----|
| Fenstergriffe | ab | 275 |
| Sicherheit | ab | 309 |
| Stoßgriffe | ab | 329 |
| Muschelgriffe | ab | 340 |
| Türstopper | ab | 345 |
| Türfixierer | ab | 347 |
| Hausnummern | ab | 348 |
| Buchstaben und Hinweisschilder | ab | 349 |

Glastürschloss **Form A**



EDELSTAHL matt



ALUMINIUM EV1



EDELSTAHL poliert



PVD Messinggelb

Bohrmaße Glastürschloss

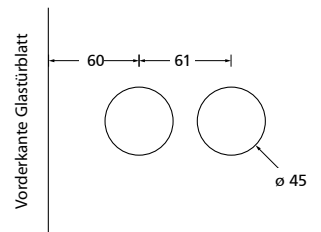

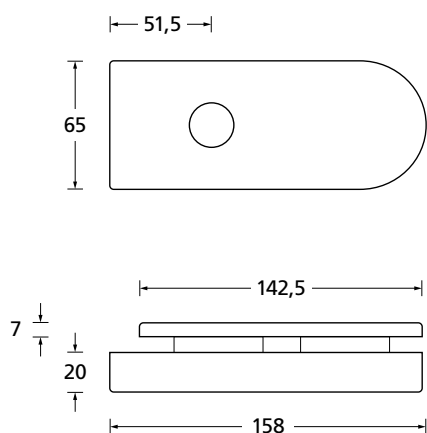

Glastürschloss Blind



Glastürschloss BB



Glastürschloss PZ



Glastürschloss WC Innen



Glastürschloss WC Außen

| Glastürschloss Form A | Edelstahl matt | | Aluminium EV1 | | Edelstahl poliert | | PVD Messinggelb | |
|-----------------------|----------------|---------------|---------------|---------------|-------------------|---------------|-----------------|---------------|
| | | € exkl. MwSt. | | € exkl. MwSt. | | € exkl. MwSt. | | € exkl. MwSt. |
| Blind | 20115 | 69,90 | 30115 | 59,90 | P20115 | 109,90 | PVM20115 | 129,90 |
| BB | 20116 | 79,90 | - | - | P20116 | 119,90 | PVM20116 | 139,90 |
| PZ | 20117 | 79,90 | 30117 | 69,90 | P20117 | 119,90 | PVM20117 | 139,90 |
| WC | 20118 | 99,90 | 30118 | 89,90 | P20118 | 139,90 | PVM20118 | 159,90 |

Glastürschloss **Form B**



EDELSTAHL matt



ALUMINIUM EV1



EDELSTAHL poliert

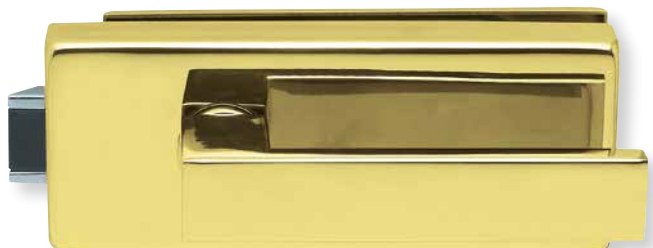

PVD Messinggelb

Bohrmaße Glastürschloss

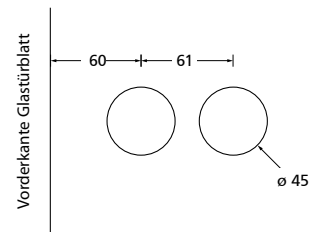

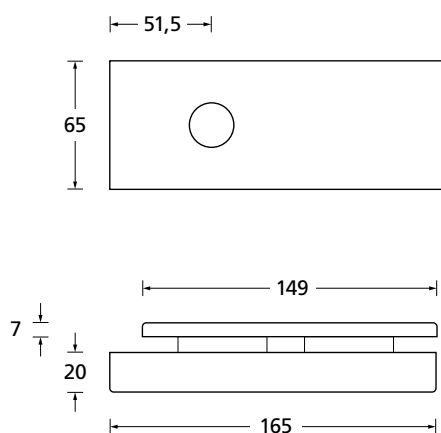

Glastürschloss Blind



Glastürschloss BB



Glastürschloss PZ



Glastürschloss WC Innen



Glastürschloss WC Außen

| Glastürschloss Form B | Edelstahl matt | | Aluminium EV1 | | Edelstahl poliert | | PVD Messinggelb | |
|-----------------------|----------------|---------------|---------------|---------------|-------------------|---------------|-----------------|---------------|
| | | € exkl. MwSt. | | € exkl. MwSt. | | € exkl. MwSt. | | € exkl. MwSt. |
| Blind | 20215 | 69,90 | 30215 | 59,90 | P20215 | 109,90 | PVM20215 | 129,90 |
| BB | 20216 | 79,90 | - | - | P20216 | 119,90 | PVM20216 | 139,90 |
| PZ | 20217 | 79,90 | 30217 | 69,90 | P20217 | 119,90 | PVM20217 | 139,90 |
| WC | 20218 | 99,90 | 30218 | 89,90 | P20218 | 139,90 | PVM20218 | 159,90 |

Glastürschloss **Form C**



EDELSTAHL matt



EDELSTAHL poliert



PVD Messinggelb

Bohrmaße Glastürschloss

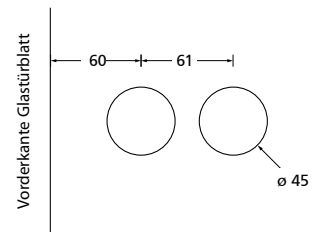

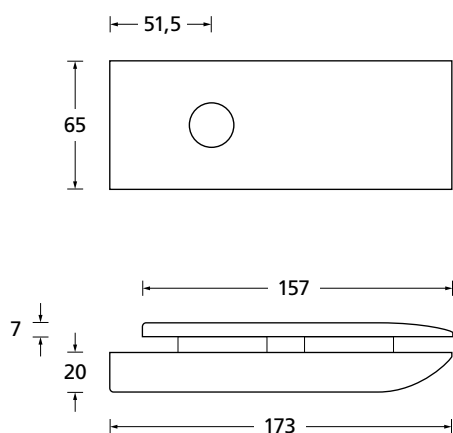

Glastürschloss Blind



Glastürschloss BB



Glastürschloss PZ



Glastürschloss WC Innen



Glastürschloss WC Außen

| Glastürschloss Form C | Edelstahl matt | | Edelstahl poliert | | PVD Messinggelb | |
|-----------------------|----------------|---------------|-------------------|---------------|-----------------|---------------|
| | | € exkl. MwSt. | | € exkl. MwSt. | | € exkl. MwSt. |
| Blind | 20315 | 69,90 | P20315 | 109,90 | PVM20315 | 129,90 |
| BB | 20316 | 79,90 | P20316 | 119,90 | PVM20316 | 139,90 |
| PZ | 20317 | 79,90 | P20317 | 119,90 | PVM20317 | 139,90 |
| WC | 20318 | 99,90 | P20318 | 139,90 | PVM20318 | 159,90 |

Gegenkasten **Form A**



EDELSTAHL matt



ALUMINIUM EV1



EDELSTAHL poliert



PVD Messinggelb

Bohrmaße Gegenkasten lang

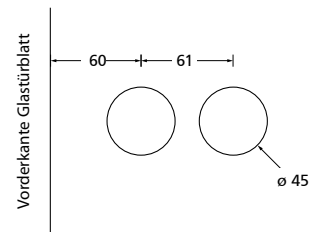

Bohrmaße Gegenkasten kurz

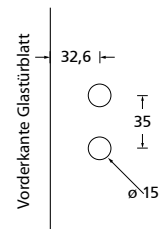

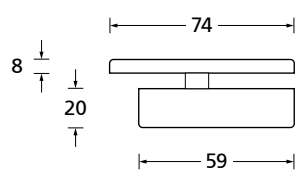
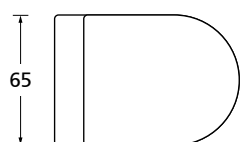
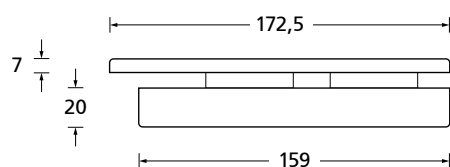

Gegenkasten lang



Gegenkasten kurz

| | Edelstahl matt | | Aluminium EV1 | | Edelstahl poliert | | PVD Messinggelb | |
|---------------------------|----------------|---------------|---------------|---------------|-------------------|---------------|-----------------|---------------|
| Gegenkasten Form A | | € exkl. MwSt. | | € exkl. MwSt. | | € exkl. MwSt. | | € exkl. MwSt. |
| lang | 20131L | 69,90 | 30131L | 59,90 | P20131L | 109,90 | PVM20131L | 129,90 |
| kurz | 20131 | 61,90 | 30131 | 51,90 | P20131 | 101,90 | PVM20131 | 121,90 |

Gegenkasten **Form B**



EDELSTAHL matt



ALUMINIUM EV1



EDELSTAHL poliert



PVD Messinggelb

Bohrmaße Gegenkasten lang

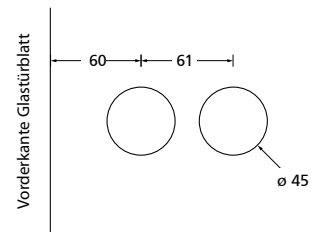

Bohrmaße Gegenkasten kurz

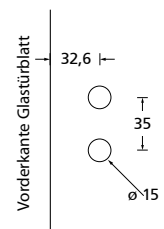

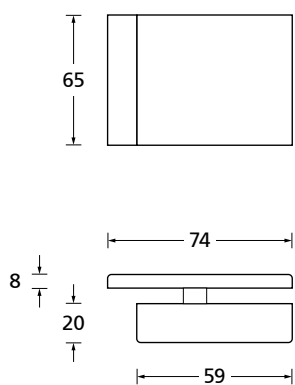
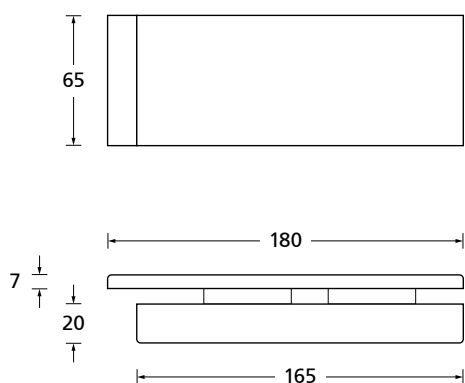

Gegenkasten lang



Gegenkasten kurz

| Gegenkasten Form B | Edelstahl matt | | Aluminium EV1 | | Edelstahl poliert | | PVD Messinggelb | |
|--------------------|----------------|---------------|---------------|---------------|-------------------|---------------|-----------------|---------------|
| | | € exkl. MwSt. | | € exkl. MwSt. | | € exkl. MwSt. | | € exkl. MwSt. |
| lang | 20231L | 69,90 | 30231L | 59,90 | P20231L | 109,90 | PVM20231L | 129,90 |
| kurz | 20231 | 61,90 | 30231 | 51,90 | P20231 | 101,90 | PVM20231 | 121,90 |

Glastürband **3-teilig** abgerundet inkl. Rahmenteil für Holzzarge

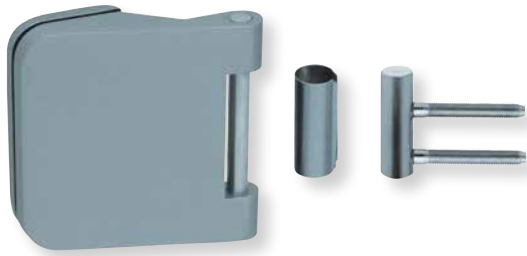

Glastürband 3-teilig abgerundet
wie EDELSTAHL matt

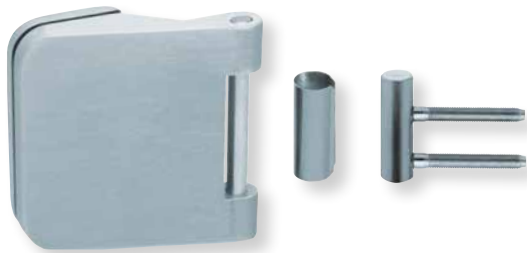

Glastürband 3-teilig abgerundet
ALUMINIUM EV1

Bohrmaße 3-teiliges Band

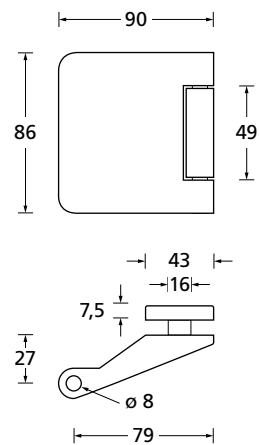
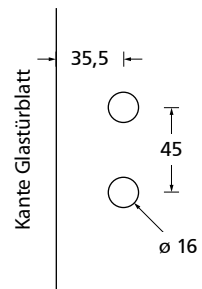

wie Edelstahl matt Aluminium EV1

| Glastürband | € exkl. MwSt. | € exkl. MwSt. |
|---------------------|---------------------|----------------------|
| 3-teilig abgerundet | Paar 20149 49,90 | Paar 201492 49,90 |



Glastürband **3-teilig** eckig inkl. Rahmenteil für Holzzarge

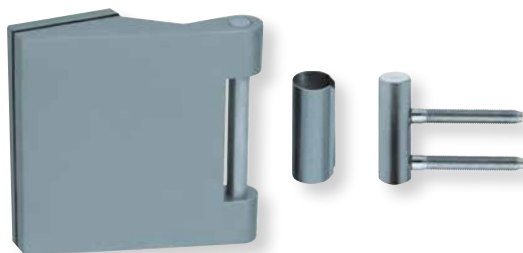

Glastürband 3-teilig eckig
wie EDELSTAHL matt

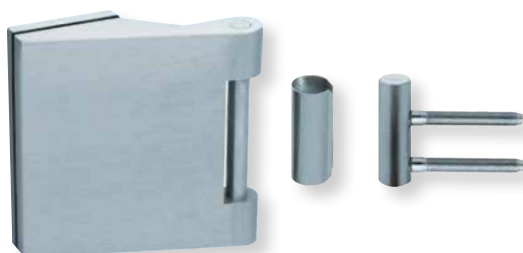

Glastürband 3-teilig eckig
ALUMINIUM EV1

Bohrmaße 3-teiliges Band

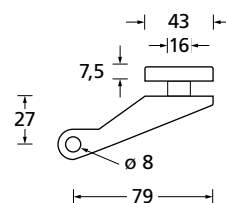
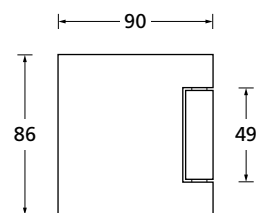
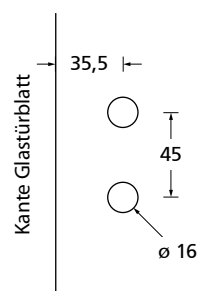

wie Edelstahl matt Aluminium EV1

| Glastürband | € exkl. MwSt. | Aluminium EV1 | € exkl. MwSt. |
|----------------|---------------|---------------|---------------|
| 3-teilig eckig | Paar | Paar | Paar |
| 20139 | 49,90 | 201392 | 49,90 |

Glastürband **3-teilig** inkl. Rahmenteil für Holzzarge

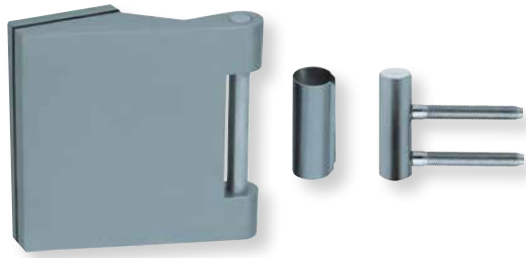

Glastürband 3-teilig massiv
EDELSTAHL matt

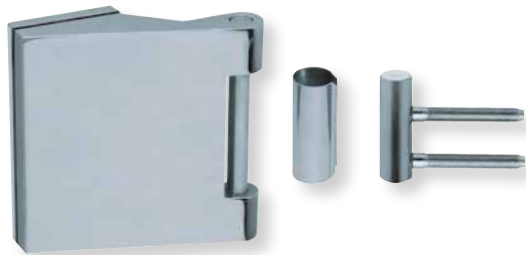

Glastürband 3-teilig massiv
EDELSTAHL poliert



Glastürband 3-teilig massiv
PVD Messinggelb

Bohrmaße 3-teiliges Band

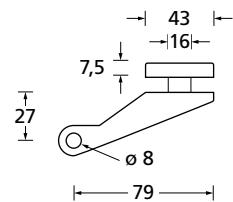
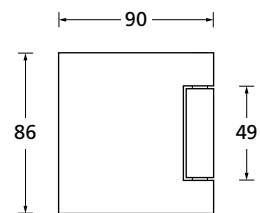
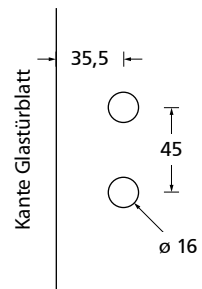

| Glastürband | Edelstahl matt | | Edelstahl poliert | | PVD Messinggelb | |
|-----------------|----------------|---------------|-------------------|---------------|-----------------|---------------|
| | | € exkl. MwSt. | | € exkl. MwSt. | | € exkl. MwSt. |
| 3-teilig massiv | | Paar | | Paar | | Paar |
| | 20129 | 69,90 | P20129 | 109,90 | PVM10124 | 129,90 |



Glastürband **3-teilig** flach inkl. Rahmenteil für Holzzarge



Glastürband 3-teilig flach
EDELSTAHL matt

Bohrmaße 3-teiliges Band

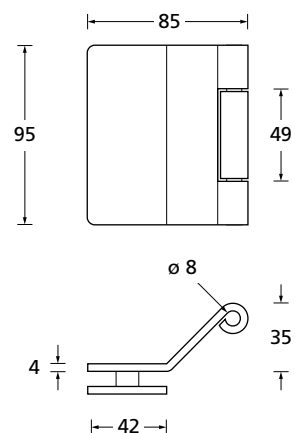
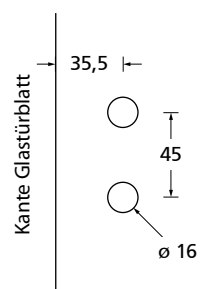

Edelstahl matt

| Glastürband | | € exkl. MwSt. |
|----------------|--------|---------------|
| 3-teilig flach | | Paar |
| | 20129F | 49,90 |

Glastürband **2-teilig** abgerundet



Glastürband 2-teilig abgerundet
wie EDELSTAHL matt



Glastürband 2-teilig abgerundet
ALUMINIUM EV1



Glastürband 2-teilig abgerundet
verchromt



Glastürband 2-teilig abgerundet
PVD Messinggelb

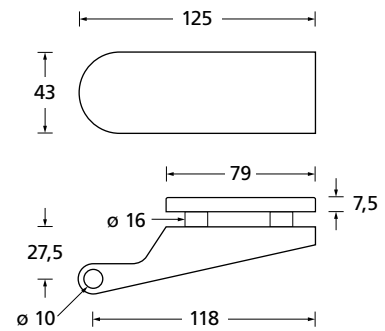
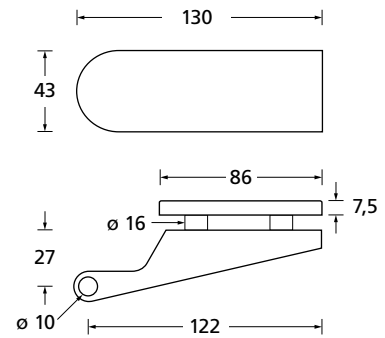

| | wie Edelstahl matt | | Aluminium EV1 | | verchromt | | PVD Messinggelb | |
|---------------------|--------------------|-------|---------------|-------|---------------|-------|-----------------|-------|
| Glastürband | € exkl. MwSt. | | € exkl. MwSt. | | € exkl. MwSt. | | € exkl. MwSt. | |
| 2-teilig abgerundet | Paar | | Paar | | Paar | | Paar | |
| | 10148 | 69,90 | 101482 | 69,90 | P10118 | 79,90 | PVM10118 | 99,90 |



Glastürband **2-teilig** eckig



Glastürband 2-teilig eckig
wie EDELSTAHL matt



Glastürband 2-teilig eckig
ALUMINIUM EV1

Bohrmaße 2-teiliges Band

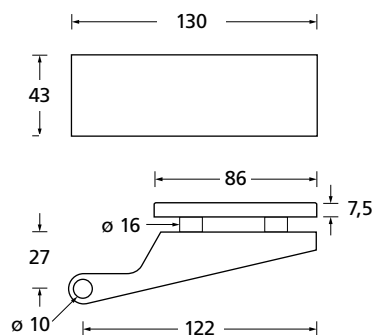
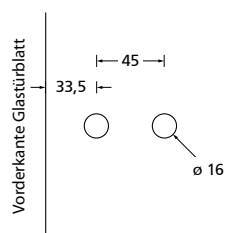

wie Edelstahl matt Aluminium EV1

| Glastürband | € exkl. MwSt. | € exkl. MwSt. |
|----------------|---------------|---------------|
| 2-teilig eckig | Paar | Paar |
| 10138 | 69,90 | 101382 69,90 |

Türfeststeller und Rollenschnäpper für Glastüren



Türfeststeller
EDELSTAHL matt

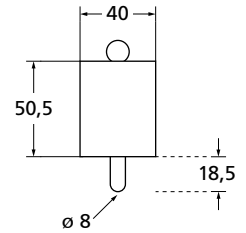

Türfeststeller
ALUMINIUM EV1

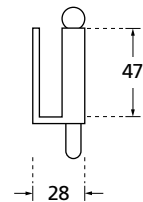

Türfeststeller
EDELSTAHL poliert

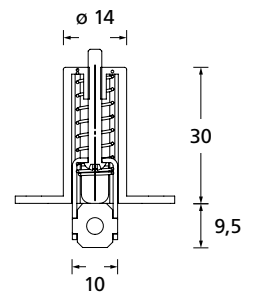

Türfeststeller
PVD Messinggelb



Rollenschnäpper

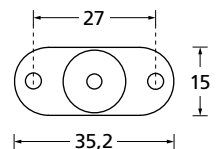

| | Edelstahl matt | Aluminium EV1 | Edelstahl poliert | PVD Messinggelb |
|------------------------|------------------------------|-------------------------------|-------------------------------|----------------------------------|
| Türfeststeller | € exkl. MwSt. 10125 59,90 | € exkl. MwSt. 101252 53,90 | € exkl. MwSt. P10125 79,90 | € exkl. MwSt. PVM10125 109,90 |
| Rollenschnäpper | € exkl. MwSt. 10126 25,90 | | | |



Knaufzylinder für WC



Knaufzylinder
wie EDELSTAHL matt



Knaufzylinder
ALUMINIUM EV1



Knaufzylinder
verchromt



Knaufzylinder
PVD Messinggelb

Knauf auf Schlossseite:

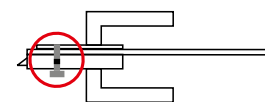
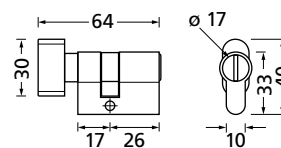

Knauf auf Schlossgegenseite:

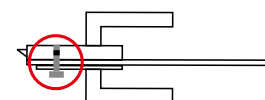
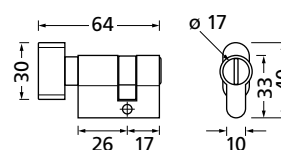

| Knaufzylinder für WC | wie Edelstahl matt | | Aluminium EV1 | | verchromt | | PVD Messinggelb | |
|----------------------|--------------------|---------------|---------------|---------------|-----------|---------------|-----------------|---------------|
| | | € exkl. MwSt. | | € exkl. MwSt. | | € exkl. MwSt. | | € exkl. MwSt. |
| 26/17 | 10111 | 29,90 | 30111 | 29,90 | P10111 | 33,90 | PVM10111 | 37,90 |
| 17/26 | 10121 | 29,90 | 30121 | 29,90 | P10121 | 33,90 | PVM10121 | 37,90 |

Stoßgriffe für Glastüren

Edelstahl matt

268



Stoßgriffe SG 16 \varnothing 25/19

Stoßgriffe SG 16 \varnothing 25/13

Edelstahl matt

| SG 16 \varnothing 25 / 19 | | € exkl. MwSt. | |
|-----------------------------------------------|--------|---------------|--|
| | | Stk. | |
| \varnothing 25 / BA 200 / GL 400 | 351613 | 25,90 | |
| \varnothing 25 / BA 300 / GL 400 | 35169 | 25,90 | |
| \varnothing 25 / BA 400 / GL 600 | 351610 | 29,90 | |

Edelstahl matt

| SG 16 25 / 13 eckig | | € exkl. MwSt. | |
|----------------------------|--------|---------------|--|
| | | Stk. | |
| 25 / 13 / BA350 / GL600 | 15163E | 41,90 | |

\varnothing = Durchmesser / BA = Bohrabstand / GL = Gesamtlänge



Montage-Sets und Muschelgriffe Edelstahl



Montage-Set für Stoßgriffe

| beidseitig (durchgebohrt) | | € exkl. MwSt. |
|----------------------------------|-------|---------------|
| | | 2 Stk. |
| für SG 16 ø 25 / 19 | 15108 | 18,30 |
| Bohrung ø 12 mm | | |
| für SG 16 25 / 13 eckig | 15112 | 18,30 |
| Bohrung ø 12 mm | | |

Montage-Set für Stoßgriffe

| einseitig (durchgebohrt) | | € exkl. MwSt. |
|---------------------------------|-------|---------------|
| | | 2 Stk. |
| für SG 16 ø 25 / 19 | 15109 | 18,30 |
| Bohrung ø 12 mm | | |
| für SG 16 25 / 13 eckig | 15113 | 18,30 |
| Bohrung ø 12 mm | | |



Glastürmuschel rund
EDELSTAHL matt



Glastürmuschel konisch
EDELSTAHL matt

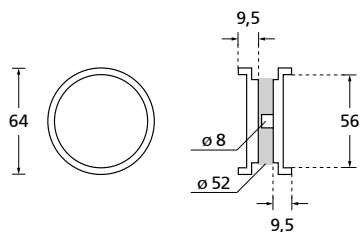

Glastürmuschel rund

| Edelstahl matt | | € exkl. MwSt. |
|-----------------------|-------|---------------|
| | | Paar |
| rund | 20036 | 25,90 |

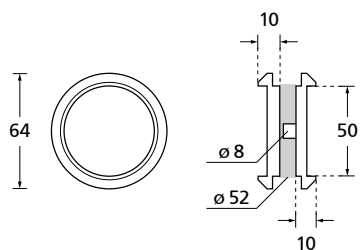

Glastürmuschel konisch

| Edelstahl matt | | € exkl. MwSt. |
|-----------------------|-------|---------------|
| | | Paar |
| konisch | 20037 | 25,90 |

Rahmenteile für Glastürbänder **3-teilig** für Holz- und Stahlzargen



Rahmenteil für Holzzarge

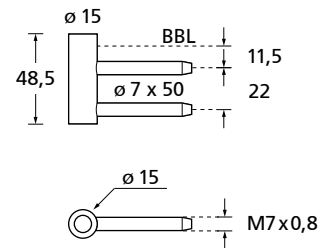

Rahmenteil für Stahlzarge

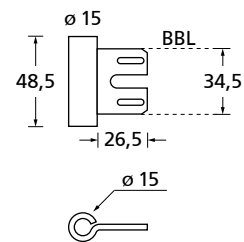

Aufschraub-Rahmenteil

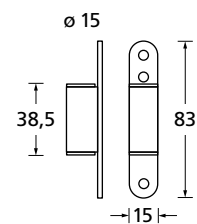

| | für Holzzarge | | für Stahlzarge | | Aufschraub-Rahmenteil | |
|-------------------|---------------|------|----------------|------|-----------------------|------|
| Rahmenteil | € exkl. MwSt. | | € exkl. MwSt. | | € exkl. MwSt. | |
| für Glastürbänder | Stk. | | Stk. | | Stk. | |
| | 10120 | 5,90 | 10122 | 5,90 | 101231 | 5,90 |

Aufschraub-Rahmenteil nicht mit Bandaufnahme der Standardbänder kompatibel. Bitte bei Bestellung angeben.



Glastürsets

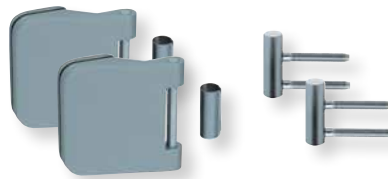

Glastürset Form A Blind mit 3-teiligen Glastürbändern abgerundet, abgesetzter Falle und Rahmenteilen für Holzzargen. EDELSTAHL matt

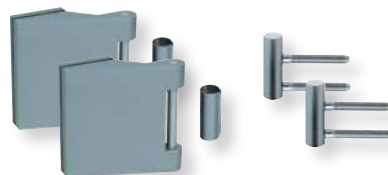

Glastürset Form B Blind mit 3-teiligen Glastürbändern eckig, abgesetzter Falle und Rahmenteilen für Holzzargen. EDELSTAHL matt

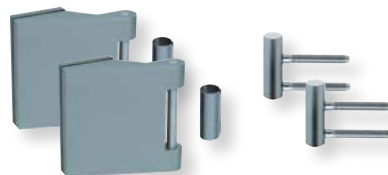

Glastürset Form C Blind mit 3-teiligen Glastürbändern eckig, abgesetzter Falle und Rahmenteilen für Holzzargen. EDELSTAHL matt

| | Edelstahl matt | | Aluminium EV1 | |
|--------------------------|----------------|---------------|---------------|---------------|
| | | € exkl. MwSt. | | € exkl. MwSt. |
| Glastürset Form A | | | | |
| Blind | R201153 | 113,90 | R301153 | 103,90 |
| BB | R201163 | 123,90 | – | – |
| PZ | R201173 | 123,90 | R301173 | 113,90 |
| WC | R201183 | 143,90 | R301183 | 133,90 |
| Glastürset Form B | | | | |
| Blind | A202153 | 113,90 | A302153 | 103,90 |
| BB | A202163 | 123,90 | – | – |
| PZ | A202173 | 123,90 | A302173 | 113,90 |
| WC | A202183 | 143,90 | A302183 | 133,90 |
| Glastürset Form C | | | | |
| Blind | A203153 | 113,90 | | |
| BB | A203163 | 123,90 | | |
| PZ | A203173 | 123,90 | | |
| WC | A203183 | 143,90 | | |



Standflügelsets



Standflügelset Form A Gegenkasten lang mit 3-teiligen Glastürbändern abgerundet, abgesetzter Falle und Rahmenteil für Holzzargen.
EDELSTAHL matt

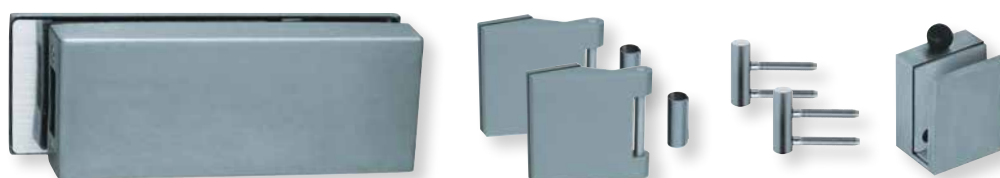

Standflügelset Form B Gegenkasten lang mit 3-teiligen Glastürbändern eckig, Rahmenteil für Holzzargen und Türfeststeller.
EDELSTAHL matt

| | Edelstahl matt | | Aluminium EV1 | |
|------------------------------|----------------|---------------|---------------|---------------|
| | | € exkl. MwSt. | | € exkl. MwSt. |
| Standflügelset Form A | | | | |
| lang | R20130L | 169,90 | R30130L | 153,90 |
| kurz | R20130 | 161,90 | R30130 | 145,90 |
| Standflügelset Form B | | | | |
| lang | A20230L | 169,90 | A30230L | 153,90 |
| kurz | A20230 | 161,90 | A30230 | 145,90 |

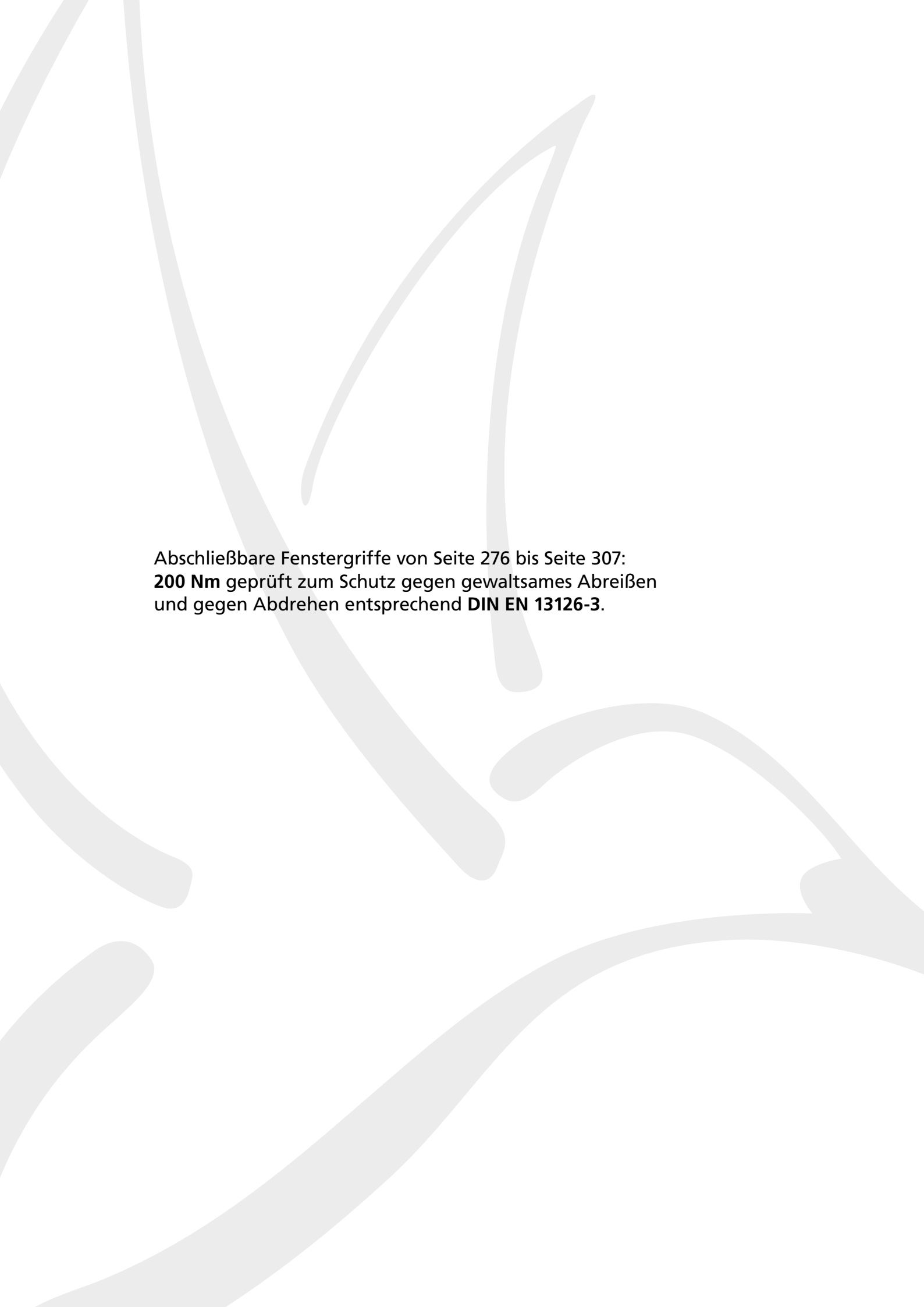

Abschließbare Fenstergriffe von Seite 276 bis Seite 307:
200 Nm geprüft zum Schutz gegen gewaltsames Abreißen
und gegen Abdrehen entsprechend **DIN EN 13126-3**.

| | | |
|---------------------------|----|-----|
| Einleitung | ab | 4 |
| Kombinationsmöglichkeiten | ab | 20 |
| Schnellübersicht Formen | ab | 22 |
| Privat- und Objektbau GK3 | ab | 29 |
| Feuerschutzgarnituren | ab | 199 |
| Rosetten/Knöpfe/Schilder | ab | 213 |
| Glastürbeschläge | ab | 249 |

Fenstergriffe

| | | |
|--------------------------------|----|-----|
| Sicherheit | ab | 309 |
| Stoßgriffe | ab | 329 |
| Muschelgriffe | ab | 340 |
| Türstopper | ab | 345 |
| Türfixierer | ab | 347 |
| Hausnummern | ab | 348 |
| Buchstaben und Hinweisschilder | ab | 349 |

Schnellübersicht Fenstergriffe auf Ovalrosette Edelstahl matt



1002
ab Seite 282



1003
ab Seite 282



1005
ab Seite 282



1007
ab Seite 284



1008
ab Seite 284



1009
ab Seite 286



1010
ab Seite 284



1011
ab Seite 286



1012
ab Seite 286



1212
ab Seite 288



1013
ab Seite 288



1016
ab Seite 288



1019
ab Seite 290



1021
ab Seite 290



1023
ab Seite 290



1025
ab Seite 292



1026
ab Seite 292



1027
ab Seite 292



1066
ab Seite 294



1070
ab Seite 294



1074
ab Seite 294



1083
ab Seite 296



1085
ab Seite 296



1100
ab Seite 298



1101
ab Seite 296



1103
ab Seite 298



1104
ab Seite 298



1106
ab Seite 300



1107
ab Seite 300



1108
ab Seite 300



1109
ab Seite 302



1173
ab Seite 302



1174
ab Seite 302



1200
ab Seite 304



1206
ab Seite 304



1275
ab Seite 304



1X74
ab Seite 306

Schnellübersicht Fenstergriffe auf Ovalrosette Edelstahl poliert



1002
ab Seite 282



1003
ab Seite 282



1005
ab Seite 282



1007
ab Seite 284



1008
ab Seite 284



1009
ab Seite 286



1010
ab Seite 284



1212
ab Seite 288



1013
ab Seite 288



1016
ab Seite 288



1021
ab Seite 290



1023
ab Seite 290



1025
ab Seite 292



1026
ab Seite 292



1027
ab Seite 292



1070
ab Seite 294



1074
ab Seite 294



1083
ab Seite 296



1085
ab Seite 296



1100
ab Seite 298



1101
ab Seite 296



1103
ab Seite 298



1104
ab Seite 298



1106
ab Seite 300



1107
ab Seite 300



1108
ab Seite 300



1109
ab Seite 302



1173
ab Seite 302



1174
ab Seite 302



1200
ab Seite 304



1275
ab Seite 304

Schnellübersicht Fenstergriffe auf Ovalrosette PVD Messinggelb



1002
ab Seite 282



1005
ab Seite 282



1008
ab Seite 284



1016
ab Seite 288



1021
ab Seite 290



1025
ab Seite 292



1026
ab Seite 292



1083
ab Seite 296



1085
ab Seite 296



1103
ab Seite 298



Fenstergriffe auf eckiger Rosette PVD Messinggelb



1002
ab Seite 282



1005
ab Seite 282



1008
ab Seite 284



1016
ab Seite 288



1021
ab Seite 290



1025
ab Seite 292



1026
ab Seite 292



1083
ab Seite 296



1085
ab Seite 296



1103
ab Seite 298

Fenstergriffe

Edelstahl

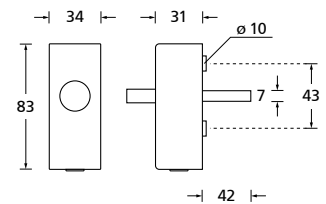
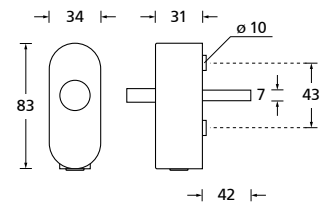
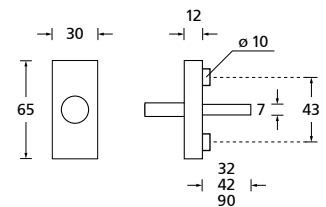
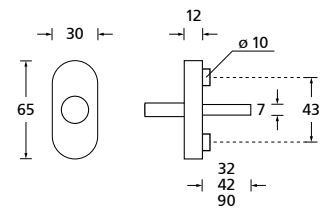
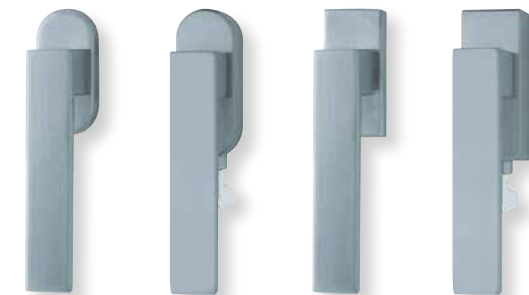



Form 1002

| | Edelstahl matt | | Edelstahl poliert | | PVD Messinggelb | |
|---------------------|----------------|---------------|-------------------|---------------|-----------------|---------------|
| Fensterolive | | € exkl. MwSt. | | € exkl. MwSt. | | € exkl. MwSt. |
| oval | 100241 | 25,90 | P100241 | 29,90 | PVM100241 | 33,90 |
| oval abschließbar | O10027 | 71,90 | OP10027 | 75,90 | OPVM10027 | 79,90 |
| eckig | E100241 | 31,90 | EP100241 | 35,90 | EPVM100241 | 39,90 |
| eckig abschließbar | E10027 | 77,90 | EP10027 | 81,90 | EPVM10027 | 85,90 |

Form 1003

| | Edelstahl matt | | Edelstahl poliert | |
|---------------------|----------------|---------------|-------------------|---------------|
| Fensterolive | | € exkl. MwSt. | | € exkl. MwSt. |
| oval | 100341 | 25,90 | P100341 | 29,90 |
| oval abschließbar | O10037 | 71,90 | OP10037 | 75,90 |
| eckig | E100341 | 31,90 | EP100341 | 35,90 |
| eckig abschließbar | E10037 | 77,90 | EP10037 | 81,90 |

Form 1005

| | Edelstahl matt | | Edelstahl poliert | | PVD Messinggelb | |
|---------------------|----------------|---------------|-------------------|---------------|-----------------|---------------|
| Fensterolive | | € exkl. MwSt. | | € exkl. MwSt. | | € exkl. MwSt. |
| oval | 100541 | 27,90 | P100541 | 31,90 | PVM100541 | 35,90 |
| oval abschließbar | O10057 | 73,90 | OP10057 | 77,90 | OPVM10057 | 81,90 |
| eckig | E100541 | 33,90 | EP100541 | 37,90 | EPVM100541 | 41,90 |
| eckig abschließbar | E10057 | 79,90 | EP10057 | 83,90 | EPVM10057 | 87,90 |

Standard-Stiftlängen unverschießbar: 32 (24/42/90) mm, abschließbar gleichschließend: 42 mm.
Aufpreis für individuell gekürzt: € 3,00

Fenstergriffe

Edelstahl

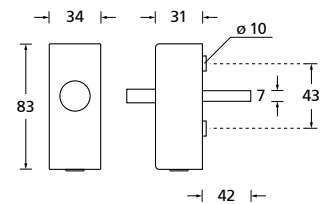
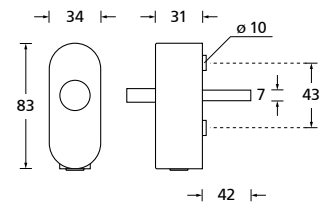
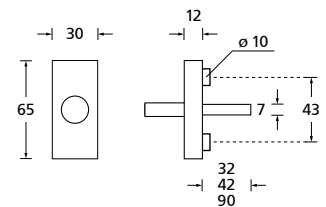
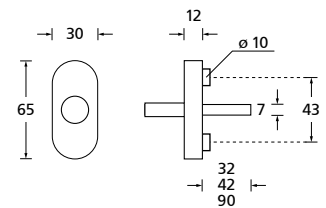
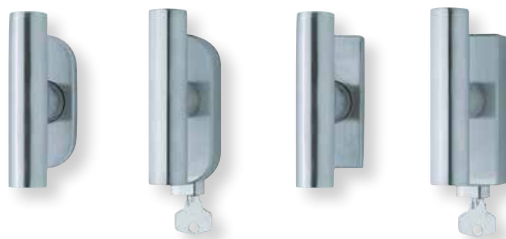



Form 1007

| Fensterolive | Edelstahl matt | | Edelstahl poliert | |
|--------------------|----------------|---------------|-------------------|---------------|
| | | € exkl. MwSt. | | € exkl. MwSt. |
| oval | 100741 | 26,90 | P100741 | 28,90 |
| oval abschließbar | O10077 | 72,90 | OP10077 | 74,90 |
| eckig | E100741 | 32,90 | EP100741 | 34,90 |
| eckig abschließbar | E10077 | 78,90 | EP10077 | 80,90 |

Form 1008

| Fensterolive | Edelstahl matt | | Edelstahl poliert | | PVD Messinggelb | |
|--------------------|----------------|---------------|-------------------|---------------|-----------------|---------------|
| | | € exkl. MwSt. | | € exkl. MwSt. | | € exkl. MwSt. |
| oval | 100841 | 25,90 | P100841 | 29,90 | PVM100841 | 33,90 |
| oval abschließbar | O10087 | 71,90 | OP10087 | 75,90 | OPVM10087 | 79,90 |
| eckig | E100841 | 31,90 | EP100841 | 35,90 | EPVM100841 | 39,90 |
| eckig abschließbar | E10087 | 77,90 | EP10087 | 81,90 | EPVM10087 | 85,90 |

Form 1010

| Fensterolive | Edelstahl matt | | Edelstahl poliert | |
|--------------------|----------------|---------------|-------------------|---------------|
| | | € exkl. MwSt. | | € exkl. MwSt. |
| oval | 101041 | 21,90 | P101041 | 25,90 |
| oval abschließbar | O10107 | 67,90 | OP10107 | 71,90 |
| eckig | E101041 | 27,90 | EP101041 | 31,90 |
| eckig abschließbar | E10107 | 73,90 | EP10107 | 77,90 |

Standard-Stiftlängen unverschießbar: 32 (24/42/90) mm, abschließbar gleichschließend: 42 mm.
Aufpreis für individuell gekürzt: € 3,00

Fenstergriffe

Edelstahl

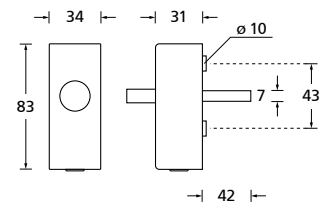
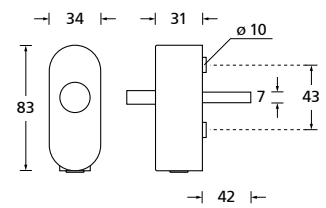
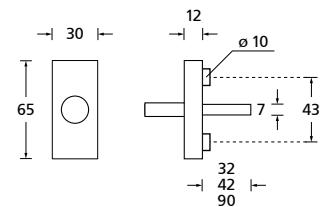
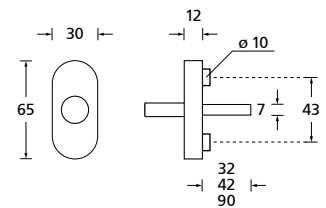



Form 1009

| Fensterolive | Edelstahl matt | | Edelstahl poliert | |
|--------------------|----------------|---------------|-------------------|---------------|
| | | € exkl. MwSt. | | € exkl. MwSt. |
| oval | 100941 | 25,90 | P100941 | 29,90 |
| oval abschließbar | O10097 | 71,90 | OP10097 | 75,90 |
| eckig | E100941 | 31,90 | EP100941 | 35,90 |
| eckig abschließbar | E10097 | 77,90 | EP10097 | 81,90 |

Form 1011

| Fensterolive | Edelstahl matt | |
|--------------------|----------------|---------------|
| | | € exkl. MwSt. |
| oval | 101141 | 25,90 |
| oval abschließbar | O10117 | 71,90 |
| eckig | E101141 | 31,90 |
| eckig abschließbar | E10117 | 77,90 |

Form 1012

| Fensterolive | Edelstahl matt | |
|--------------------|----------------|---------------|
| | | € exkl. MwSt. |
| oval | 101241 | 25,90 |
| oval abschließbar | O10127 | 71,90 |
| eckig | E101241 | 31,90 |
| eckig abschließbar | E10127 | 77,90 |

Fenstergriffe Edelstahl

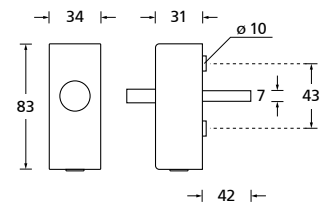
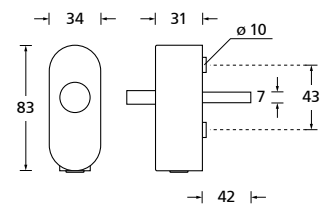
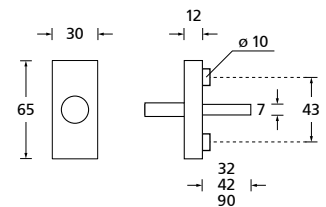
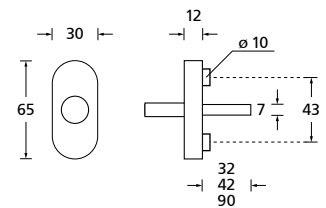



Form 1212

| Fensterolive | Edelstahl matt | | Edelstahl poliert | |
|--------------------|----------------|---------------|-------------------|---------------|
| | | € exkl. MwSt. | | € exkl. MwSt. |
| oval | 121241 | 26,90 | P121241 | 28,90 |
| oval abschließbar | O12127 | 72,90 | OP12127 | 74,90 |
| eckig | E121241 | 32,90 | EP121241 | 34,90 |
| eckig abschließbar | E12127 | 78,90 | EP12127 | 80,90 |

Form 1013

| Fensterolive | Edelstahl matt | | Edelstahl poliert | |
|--------------------|----------------|---------------|-------------------|---------------|
| | | € exkl. MwSt. | | € exkl. MwSt. |
| oval | 101341 | 26,90 | P101341 | 28,90 |
| oval abschließbar | O10137 | 72,90 | OP10137 | 74,90 |
| eckig | E101341 | 32,90 | EP101341 | 34,90 |
| eckig abschließbar | E10137 | 78,90 | EP10137 | 80,90 |

Form 1016

| Fensterolive | Edelstahl matt | | Edelstahl poliert | | PVD Messinggelb | |
|--------------------|----------------|---------------|-------------------|---------------|-----------------|---------------|
| | | € exkl. MwSt. | | € exkl. MwSt. | | € exkl. MwSt. |
| oval | 101641 | 27,90 | P101641 | 31,90 | PVM101641 | 35,90 |
| oval abschließbar | O10167 | 73,90 | OP10167 | 77,90 | OPVM10167 | 81,90 |
| eckig | E101641 | 33,90 | EP101641 | 37,90 | EPVM101641 | 41,90 |
| eckig abschließbar | E10167 | 79,90 | EP10167 | 83,90 | EPVM10167 | 87,90 |

Standard-Stiftlängen unverschießbar: 32 (24/42/90) mm, abschließbar gleichschließend: 42 mm.
Aufpreis für individuell gekürzt: € 3,00

Fenstergriffe

Edelstahl

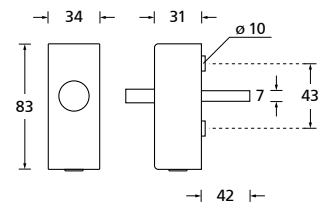
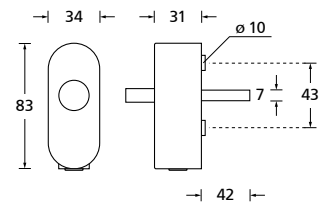
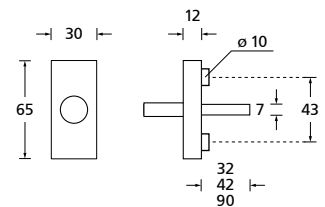
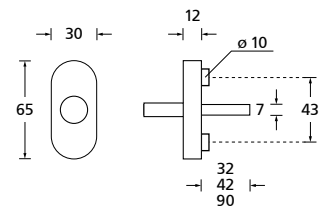



Form 1019

Edelstahl matt

| Fensterolive | | € exkl. MwSt. |
|---------------------|---------|---------------|
| oval | 101941 | 25,90 |
| oval abschließbar | O10197 | 71,90 |
| eckig | E101941 | 31,90 |
| eckig abschließbar | E10197 | 77,90 |

Form 1021

Edelstahl matt

Edelstahl poliert

PVD Messinggelb

| Fensterolive | | € exkl. MwSt. | | € exkl. MwSt. | | € exkl. MwSt. |
|---------------------|---------|---------------|----------|---------------|------------|---------------|
| oval | 102141 | 29,90 | P102141 | 33,90 | PVM102141 | 37,90 |
| oval abschließbar | O10217 | 75,90 | OP10217 | 79,90 | OPVM10217 | 83,90 |
| eckig | E102141 | 35,90 | EP102141 | 39,90 | EPVM102141 | 43,90 |
| eckig abschließbar | E10217 | 81,90 | EP10217 | 85,90 | EPVM10217 | 89,90 |

Form 1023

Edelstahl matt

Edelstahl poliert

| Fensterolive | | € exkl. MwSt. | | € exkl. MwSt. |
|---------------------|---------|---------------|----------|---------------|
| oval | 102341 | 25,90 | P102341 | 29,90 |
| oval abschließbar | O10237 | 71,90 | OP10237 | 75,90 |
| eckig | E102341 | 31,90 | EP102341 | 35,90 |
| eckig abschließbar | E10237 | 77,90 | EP10237 | 81,90 |

Standard-Stiftlängen unverschießbar: 32 (24/42/90) mm, abschließbar gleichschließend: 42 mm.
Aufpreis für individuell gekürzt: € 3,00

Fenstergriffe

Edelstahl

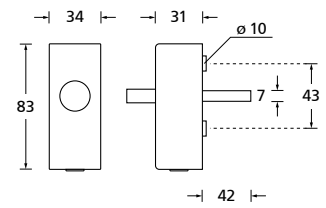
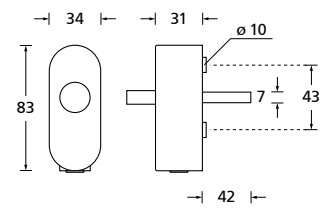
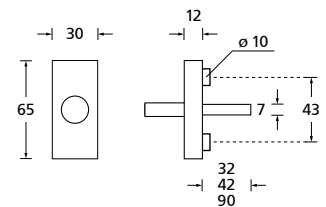
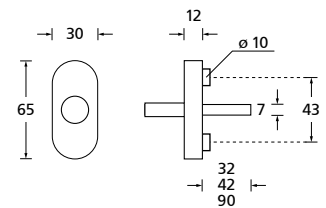



Form 1025

| | Edelstahl matt | | Edelstahl poliert | | PVD Messinggelb | |
|---------------------|----------------|-------|-------------------|-------|-----------------|-------|
| Fensterolive | € exkl. MwSt. | | € exkl. MwSt. | | € exkl. MwSt. | |
| oval | 102541 | 27,90 | P102541 | 31,90 | PVM102541 | 35,90 |
| oval abschließbar | O10257 | 73,90 | OP10257 | 77,90 | OPVM10257 | 81,90 |
| eckig | E102541 | 33,90 | EP102541 | 37,90 | EPVM102541 | 41,90 |
| eckig abschließbar | E10257 | 79,90 | EP10257 | 83,90 | EPVM10257 | 87,90 |

Form 1026

| | Edelstahl matt | | Edelstahl poliert | | PVD Messinggelb | |
|---------------------|----------------|-------|-------------------|-------|-----------------|-------|
| Fensterolive | € exkl. MwSt. | | € exkl. MwSt. | | € exkl. MwSt. | |
| oval | 102641 | 27,90 | P102641 | 31,90 | PVM102641 | 35,90 |
| oval abschließbar | O10267 | 73,90 | OP10267 | 77,90 | OPVM10267 | 81,90 |
| eckig | E102641 | 33,90 | EP102641 | 37,90 | EPVM102641 | 41,90 |
| eckig abschließbar | E10267 | 79,90 | EP10267 | 83,90 | EPVM10267 | 87,90 |

Form 1027

| | Edelstahl matt | | Edelstahl poliert | |
|---------------------|----------------|-------|-------------------|-------|
| Fensterolive | € exkl. MwSt. | | € exkl. MwSt. | |
| oval | 102741 | 27,90 | P102741 | 31,90 |
| oval abschließbar | O10277 | 73,90 | OP10277 | 77,90 |
| eckig | E102741 | 33,90 | EP102741 | 37,90 |
| eckig abschließbar | E10277 | 79,90 | EP10277 | 83,90 |

Standard-Stiftlängen unverschießbar: 32 (24/42/90) mm, abschließbar gleichschließend: 42 mm.
Aufpreis für individuell gekürzt: € 3,00

Fenstergriffe Edelstahl

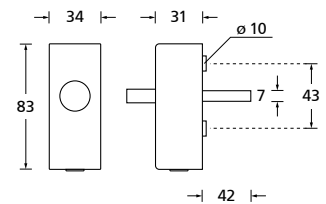
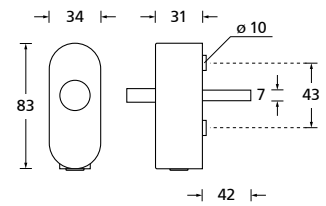
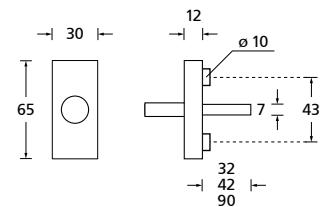
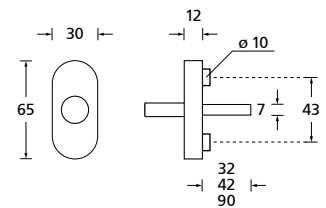
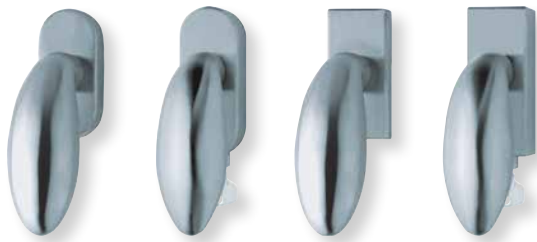



Form 1066

Edelstahl matt

| Fensterolive | | € exkl. MwSt. |
|---------------------|---------|---------------|
| oval | 106641 | 27,90 |
| oval abschließbar | O10667 | 73,90 |
| eckig | E106641 | 33,90 |
| eckig abschließbar | E10667 | 79,90 |

Form 1070

Edelstahl matt

Edelstahl poliert

| Fensterolive | | € exkl. MwSt. | | € exkl. MwSt. |
|---------------------|---------|---------------|----------|---------------|
| oval | 107041 | 25,90 | P107041 | 29,90 |
| oval abschließbar | O10707 | 71,90 | OP10707 | 75,90 |
| eckig | E107041 | 31,90 | EP107041 | 35,90 |
| eckig abschließbar | E10707 | 77,90 | EP10707 | 81,90 |

Form 1074

Edelstahl matt

Edelstahl poliert

| Fensterolive | | € exkl. MwSt. | | € exkl. MwSt. |
|---------------------|---------|---------------|----------|---------------|
| oval | 107441 | 21,90 | P107441 | 25,90 |
| oval abschließbar | O10747 | 67,90 | OP10747 | 71,90 |
| eckig | E107441 | 27,90 | EP107441 | 31,90 |
| eckig abschließbar | E10747 | 73,90 | EP10747 | 77,90 |

Fenstergriffe

Edelstahl

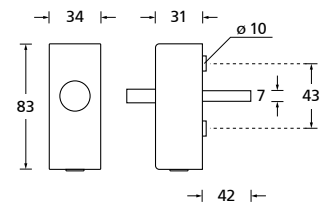
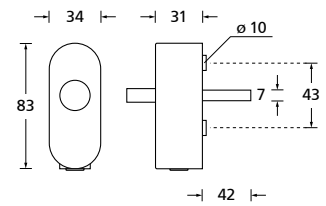
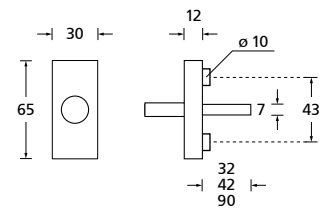
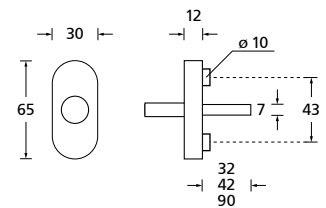



Form 1083

| | Edelstahl matt | | Edelstahl poliert | | PVD Messinggelb | |
|---------------------|----------------|---------------|-------------------|---------------|-----------------|---------------|
| Fensterolive | | € exkl. MwSt. | | € exkl. MwSt. | | € exkl. MwSt. |
| oval | 108341 | 25,90 | P108341 | 29,90 | PVM108341 | 33,90 |
| oval abschließbar | O10837 | 71,90 | OP10837 | 75,90 | OPVM10837 | 79,90 |
| eckig | E108341 | 31,90 | EP108341 | 35,90 | EPVM108341 | 39,90 |
| eckig abschließbar | E10837 | 77,90 | EP10837 | 81,90 | EPVM10837 | 85,90 |

Form 1085

| | Edelstahl matt | | Edelstahl poliert | | PVD Messinggelb | |
|---------------------|----------------|---------------|-------------------|---------------|-----------------|---------------|
| Fensterolive | | € exkl. MwSt. | | € exkl. MwSt. | | € exkl. MwSt. |
| oval | 108541 | 21,90 | P108541 | 25,90 | PVM108541 | 29,90 |
| oval abschließbar | O10857 | 67,90 | OP10857 | 71,90 | OPVM10857 | 75,90 |
| eckig | E108541 | 27,90 | EP108541 | 31,90 | EPVM108541 | 35,90 |
| eckig abschließbar | E10857 | 73,90 | EP10857 | 77,90 | EPVM10857 | 81,90 |

Form 1101

| | Edelstahl matt | | Edelstahl poliert | |
|---------------------|----------------|---------------|-------------------|---------------|
| Fensterolive | | € exkl. MwSt. | | € exkl. MwSt. |
| oval | 110141 | 24,90 | P110141 | 26,90 |
| oval abschließbar | O11017 | 70,90 | OP11017 | 72,90 |
| eckig | E110141 | 30,90 | EP110141 | 32,90 |
| eckig abschließbar | E11017 | 76,90 | EP11017 | 78,90 |

Standard-Stiftlängen unverschießbar: 32 (24/42/90) mm, abschließbar gleichschließend: 42 mm.
Aufpreis für individuell gekürzt: € 3,00

Fenstergriffe

Edelstahl

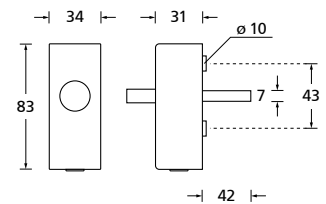
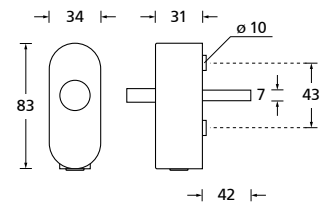
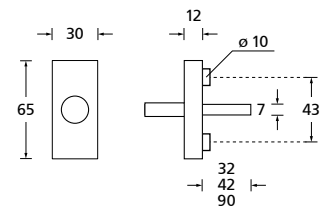
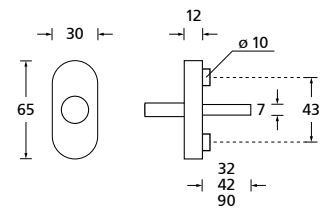



Form 1100

| Fensterolive | Edelstahl matt | | Edelstahl poliert | |
|--------------------|----------------|---------------|-------------------|---------------|
| | | € exkl. MwSt. | | € exkl. MwSt. |
| oval | 110041 | 21,90 | P110041 | 25,90 |
| oval abschließbar | O11007 | 67,90 | OP11007 | 71,90 |
| eckig | E110041 | 27,90 | EP110041 | 31,90 |
| eckig abschließbar | E11007 | 73,90 | EP11007 | 77,90 |

Form 1103

| Fensterolive | Edelstahl matt | | Edelstahl poliert | | PVD Messinggelb | |
|--------------------|----------------|---------------|-------------------|---------------|-----------------|---------------|
| | | € exkl. MwSt. | | € exkl. MwSt. | | € exkl. MwSt. |
| oval | 110341 | 25,90 | P110341 | 29,90 | PVM110341 | 33,90 |
| oval abschließbar | O11037 | 71,90 | OP11037 | 75,90 | OPVM11037 | 79,90 |
| eckig | E110341 | 31,90 | EP110341 | 35,90 | EPVM110341 | 39,90 |
| eckig abschließbar | E11037 | 77,90 | EP11037 | 81,90 | EPVM11037 | 85,90 |

Form 1104

| Fensterolive | Edelstahl matt | | Edelstahl poliert | |
|--------------------|----------------|---------------|-------------------|---------------|
| | | € exkl. MwSt. | | € exkl. MwSt. |
| oval | 110441 | 21,90 | P110441 | 25,90 |
| oval abschließbar | O11047 | 67,90 | OP11047 | 71,90 |
| eckig | E110441 | 27,90 | EP110441 | 31,90 |
| eckig abschließbar | E11047 | 73,90 | EP11047 | 77,90 |

Standard-Stiftlängen unverschießbar: 32 (24/42/90) mm, abschließbar gleichschließend: 42 mm.
Aufpreis für individuell gekürzt: € 3,00

Fenstergriffe

Edelstahl

300

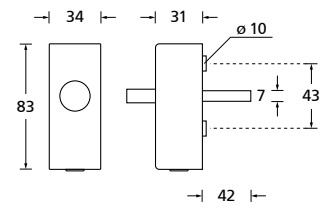
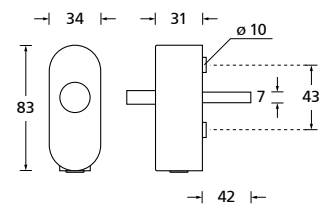
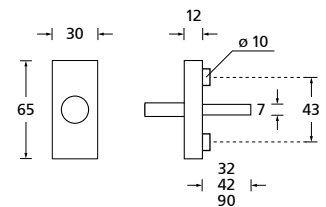
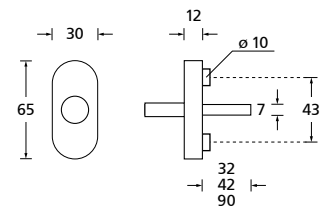

Abschließbare Fenstergriffe: **200 Nm** geprüft zum Schutz gegen gewaltsames Abreißen und gegen Abdrehen entsprechend **DIN EN 13126-3**.



Form 1107

| Fensterolive | Edelstahl matt | | Edelstahl poliert | |
|--------------------|----------------|---------------|-------------------|---------------|
| | | € exkl. MwSt. | | € exkl. MwSt. |
| oval | 110741 | 21,90 | P110741 | 25,90 |
| oval abschließbar | O11077 | 67,90 | OP11077 | 71,90 |
| eckig | E110741 | 27,90 | EP110741 | 31,90 |
| eckig abschließbar | E11077 | 73,90 | EP11077 | 77,90 |

Form 1106

| Fensterolive | Edelstahl matt | | Edelstahl poliert | |
|--------------------|----------------|---------------|-------------------|---------------|
| | | € exkl. MwSt. | | € exkl. MwSt. |
| oval | 110641 | 21,90 | P110641 | 25,90 |
| oval abschließbar | O11067 | 67,90 | OP11067 | 71,90 |
| eckig | E110641 | 27,90 | EP110641 | 31,90 |
| eckig abschließbar | E11067 | 73,90 | EP11067 | 77,90 |

Form 1108

| Fensterolive | Edelstahl matt | | Edelstahl poliert | |
|--------------------|----------------|---------------|-------------------|---------------|
| | | € exkl. MwSt. | | € exkl. MwSt. |
| oval | 110841 | 21,90 | P110841 | 25,90 |
| oval abschließbar | O11087 | 67,90 | OP11087 | 71,90 |
| eckig | E110841 | 27,90 | EP110841 | 31,90 |
| eckig abschließbar | E11087 | 73,90 | EP11087 | 77,90 |

Standard-Stiftlängen unverschießbar: 32 (24/42/90) mm, abschließbar gleichschließend: 42 mm.
Aufpreis für individuell gekürzt: € 3,00

Fenstergriffe

Edelstahl

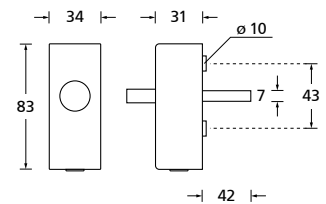
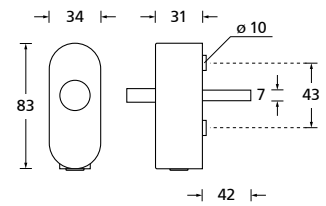
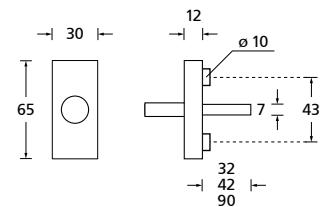
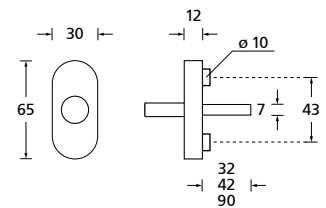



Form 1109

| Fensterolive | Edelstahl matt | | Edelstahl poliert | |
|--------------------|----------------|---------------|-------------------|---------------|
| | | € exkl. MwSt. | | € exkl. MwSt. |
| oval | 110941 | 21,90 | P110941 | 25,90 |
| oval abschließbar | O11097 | 67,90 | OP11097 | 71,90 |
| eckig | E110941 | 27,90 | EP110941 | 31,90 |
| eckig abschließbar | E11097 | 73,90 | EP11097 | 77,90 |

Form 1173

| Fensterolive | Edelstahl matt | | Edelstahl poliert | |
|--------------------|----------------|---------------|-------------------|---------------|
| | | € exkl. MwSt. | | € exkl. MwSt. |
| oval | 117341 | 22,90 | P117341 | 24,90 |
| oval abschließbar | O11737 | 68,90 | OP11737 | 70,90 |
| eckig | E117341 | 28,90 | EP117341 | 30,90 |
| eckig abschließbar | E11737 | 74,90 | EP11737 | 76,90 |

Form 1174

| Fensterolive | Edelstahl matt | | Edelstahl poliert | |
|--------------------|----------------|---------------|-------------------|---------------|
| | | € exkl. MwSt. | | € exkl. MwSt. |
| oval | 117441 | 22,90 | P117441 | 24,90 |
| oval abschließbar | O11747 | 68,90 | OP11747 | 70,90 |
| eckig | E117441 | 28,90 | EP117441 | 30,90 |
| eckig abschließbar | E11747 | 74,90 | EP11747 | 76,90 |

Standard-Stiftlängen unverschiebbar: 32 (24/42/90) mm, abschließbar gleichschließend: 42 mm.
Aufpreis für individuell gekürzt: € 3,00

Fenstergriffe

Edelstahl

304

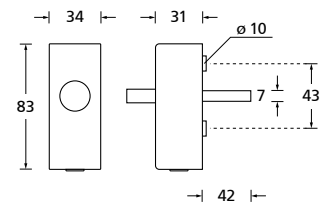
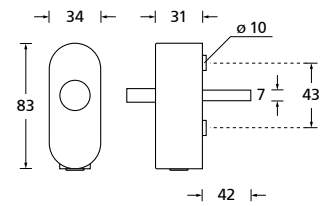
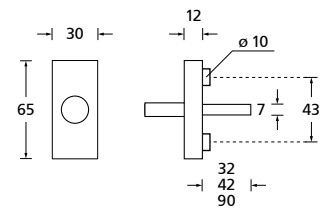
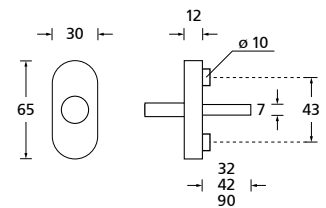

Abschließbare Fenstergriffe: **200 Nm** geprüft zum Schutz gegen gewaltsames Abreißen und gegen Abdrehen entsprechend **DIN EN 13126-3**.



Form 1200

| Fensterolive | Edelstahl matt | | Edelstahl poliert | |
|--------------------|----------------|---------------|-------------------|---------------|
| | | € exkl. MwSt. | | € exkl. MwSt. |
| oval | 120041 | 21,90 | P120041 | 25,90 |
| oval abschließbar | O12007 | 67,90 | OP12007 | 71,90 |
| eckig | E120041 | 27,90 | EP120041 | 31,90 |
| eckig abschließbar | E12007 | 73,90 | EP12007 | 77,90 |

Form 1206

| Fensterolive | Edelstahl matt | |
|--------------------|----------------|---------------|
| | | € exkl. MwSt. |
| oval | 120641 | 22,90 |
| oval abschließbar | O12067 | 68,90 |
| eckig | E120641 | 28,90 |
| eckig abschließbar | E12067 | 74,90 |

Form 1275

| Fensterolive | Edelstahl matt | | Edelstahl poliert | |
|--------------------|----------------|---------------|-------------------|---------------|
| | | € exkl. MwSt. | | € exkl. MwSt. |
| oval | 127541 | 24,90 | P127541 | 26,90 |
| oval abschließbar | O12757 | 70,90 | OP12757 | 72,90 |
| eckig | E127541 | 30,90 | EP127541 | 32,90 |
| eckig abschließbar | E12757 | 76,90 | EP12757 | 78,90 |

Standard-Stiftlängen unverschießbar: 32 (24/42/90) mm, abschließbar gleichschließend: 42 mm.
Aufpreis für individuell gekürzt: € 3,00

Fenstergriffe Edelstahl



306

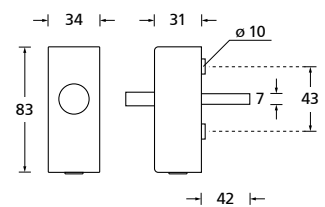
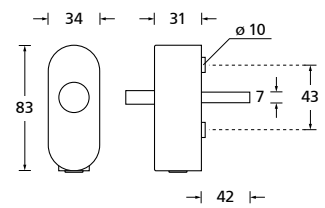
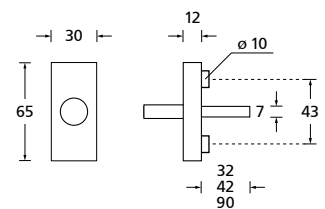
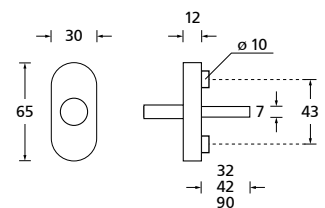



Form **1X74**

Edelstahl matt

| Fensterolive | | € exkl. MwSt. |
|---------------------|---------|---------------|
| oval | 1X7441 | 31,90 |
| oval abschließbar | O1X747 | 77,90 |
| eckig | E1X7441 | 37,90 |
| eckig abschließbar | E1X747 | 83,90 |

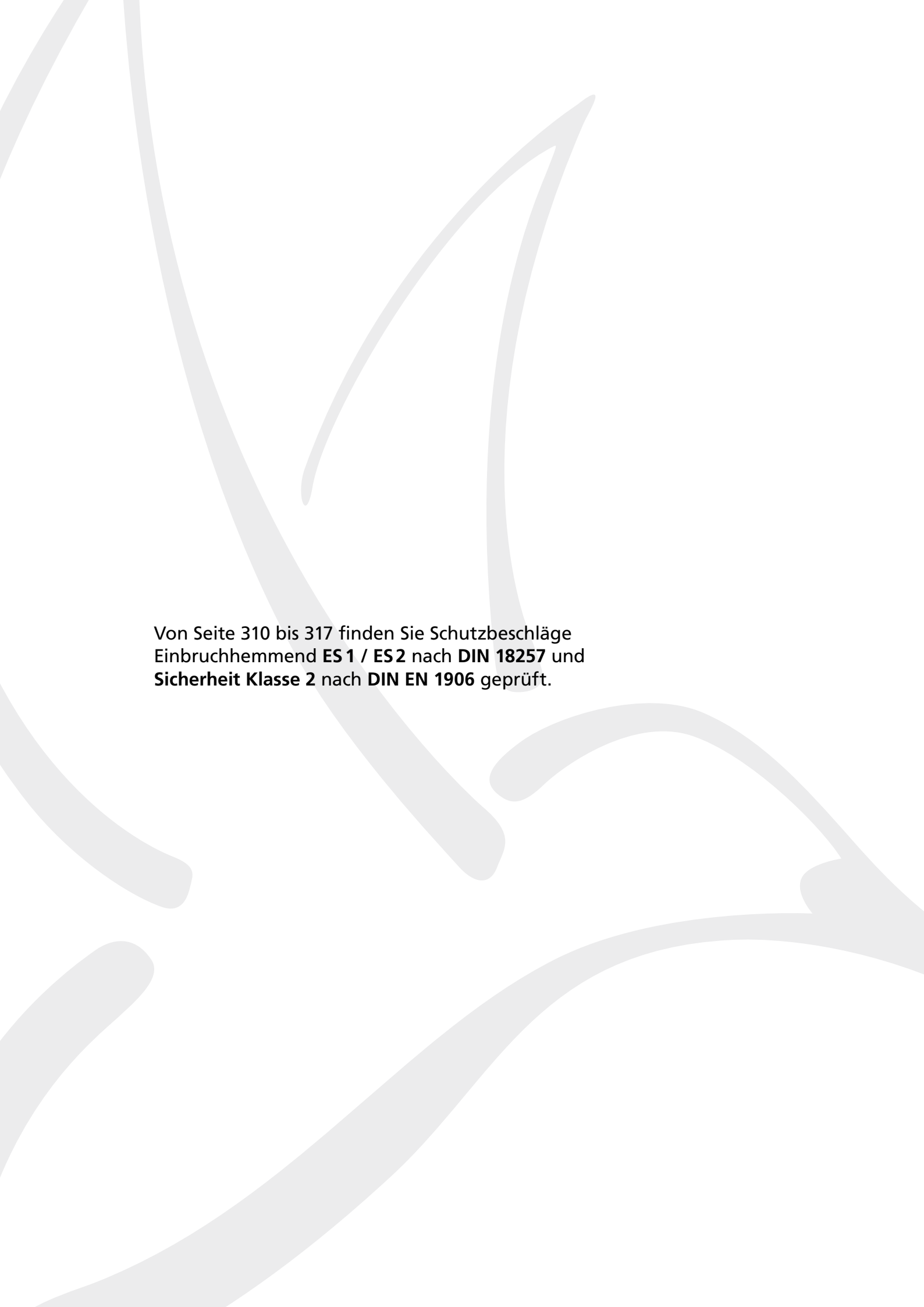

Von Seite 310 bis 317 finden Sie Schutzbeschläge
Einbruchhemmend **ES 1 / ES 2** nach **DIN 18257** und
Sicherheit Klasse 2 nach **DIN EN 1906** geprüft.

| | | |
|---------------------------|----|-----|
| Einleitung | ab | 4 |
| Kombinationsmöglichkeiten | ab | 20 |
| Schnellübersicht Formen | ab | 22 |
| Privat- und Objektbau GK3 | ab | 29 |
| Feuerschutzgarnituren | ab | 199 |
| Rosetten/Knöpfe/Schilder | ab | 213 |
| Glastürbeschläge | ab | 249 |
| Fenstergriffe | ab | 275 |

Sicherheit

| | | |
|--------------------------------|----|-----|
| Stoßgriffe | ab | 329 |
| Muschelgriffe | ab | 340 |
| Türstopper | ab | 345 |
| Türfixierer | ab | 347 |
| Hausnummern | ab | 348 |
| Buchstaben und Hinweisschilder | ab | 349 |

Schutzbeschlag

Griffknopf/Drücker

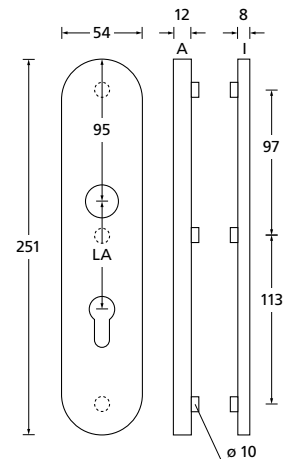

Schutzbeschlag Edelstahl matt

ES 1 DIN 18257 (SK 2 DIN EN 1906) € exkl. MwSt.

| | | |
|---------------|-----------|--------|
| PZ - LA 72 mm | 39000GES1 | 127,90 |
| PZ - LA 92 mm | 39001GES1 | 127,90 |
| RZ - LA 78 mm | 39006GES1 | 157,90 |

ÖNORM

| | | |
|---------------|-------------|--------|
| PZ - LA 88 mm | 3900230GES1 | 127,90 |
|---------------|-------------|--------|

Feuerschutz DIN 18273

| | | |
|---------------|-------------|--------|
| PZ - LA 72 mm | 39100GES1FS | 151,90 |
|---------------|-------------|--------|

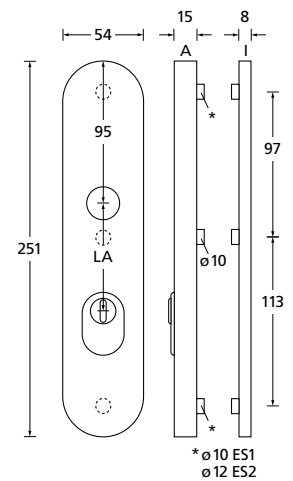

Zylinderüberstand
ES 1: 12 - 17 mm
ES 2: 11 - 14 mm

Schutzbeschlag mit Kernziehschutz Edelstahl matt

ES 1 DIN 18257 (SK 2 DIN EN 1906) € exkl. MwSt.

| | | |
|---------------|-----------|--------|
| PZ - LA 72 mm | 39010GES1 | 141,90 |
| PZ - LA 92 mm | 39011GES1 | 141,90 |

ÖNORM

| | | |
|---------------|-------------|--------|
| PZ - LA 88 mm | 3901230GES1 | 141,90 |
|---------------|-------------|--------|

Feuerschutz ÖNORM B 3859

| | | |
|---------------|---------------|--------|
| PZ - LA 88 mm | 3911230GES1FS | 163,90 |
|---------------|---------------|--------|

Feuerschutz DIN 18273

| | | |
|---------------|-------------|--------|
| PZ - LA 72 mm | 39110GES1FS | 163,90 |
|---------------|-------------|--------|

ES 2 DIN 18257 (SK 3 DIN EN 1906) € exkl. MwSt.

| | | |
|---------------|-----------|--------|
| PZ - LA 72 mm | 39010GES2 | 165,90 |
| PZ - LA 92 mm | 39011GES2 | 165,90 |

ÖNORM

| | | |
|---------------|-------------|--------|
| PZ - LA 88 mm | 3901230GES2 | 165,90 |
|---------------|-------------|--------|

Feuerschutz DIN 18273

| | | |
|---------------|-------------|--------|
| PZ - LA 72 mm | 39110GES2FS | 189,90 |
|---------------|-------------|--------|

Standard-Türstärken: 35 - 55 mm, Aufpreis für Türstärken ab 55 mm: € 7,90. Standard-Türstärken Feuerschutz: 39 - 58 mm. Bei Bestellung bitte **immer** angeben. **Kombinierbar mit allen Drückerformen** (Feuerschutz auf Anfrage). **Inkl. Form 1106.**



Schutzbeschlag

Zylindrischer Knopf/Drücker

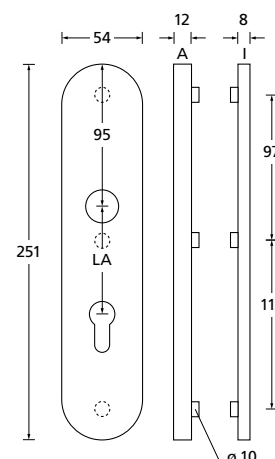

Schutzbeschlag Edelstahl matt

ES 1 DIN 18257 (SK 2 DIN EN 1906) € exkl. MwSt.

| | | |
|---------------|-----------|--------|
| PZ - LA 72 mm | 39000KES1 | 127,90 |
| PZ - LA 92 mm | 39001KES1 | 127,90 |
| RZ - LA 78 mm | 39006KES1 | 157,90 |

ÖNORM

| | | |
|---------------|-------------|--------|
| PZ - LA 88 mm | 3900230KES1 | 127,90 |
|---------------|-------------|--------|

Feuerschutz DIN 18273

| | | |
|---------------|-------------|--------|
| PZ - LA 72 mm | 39100KES1FS | 151,90 |
|---------------|-------------|--------|

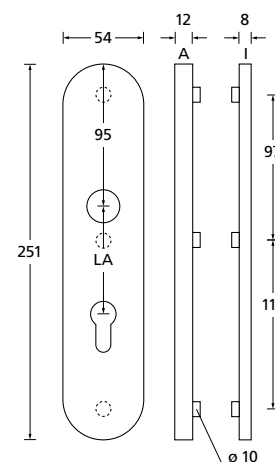

Schutzbeschlag Edelstahl matt

ES 1 DIN 18257 (SK 2 DIN EN 1906) € exkl. MwSt.

| | | |
|---------------|-----------|--------|
| PZ - LA 72 mm | 39010KES1 | 141,90 |
| PZ - LA 92 mm | 39011KES1 | 141,90 |

ÖNORM

| | | |
|---------------|-------------|--------|
| PZ - LA 88 mm | 3901230KES1 | 141,90 |
|---------------|-------------|--------|

Feuerschutz ÖNORM B 3859

| | | |
|---------------|---------------|--------|
| PZ - LA 88 mm | 3911230KES1FS | 163,90 |
|---------------|---------------|--------|

Feuerschutz DIN 18273

| | | |
|---------------|-------------|--------|
| PZ - LA 72 mm | 39110KES1FS | 163,90 |
|---------------|-------------|--------|

ES 2 DIN 18257 (SK 3 DIN EN 1906) € exkl. MwSt.

| | | |
|---------------|-----------|--------|
| PZ - LA 72 mm | 39010KES2 | 165,90 |
| PZ - LA 92 mm | 39011KES2 | 165,90 |

ÖNORM

| | | |
|---------------|-------------|--------|
| PZ - LA 88 mm | 3901230KES2 | 165,90 |
|---------------|-------------|--------|

Feuerschutz DIN 18273

| | | |
|---------------|-------------|--------|
| PZ - LA 72 mm | 39110KES2FS | 189,90 |
|---------------|-------------|--------|

Zylinderüberstand
ES 1: 12 - 17 mm
ES 2: 11 - 14 mm

Standard-Türstärken: 35 - 55 mm, Aufpreis für Türstärken ab 55 mm: € 7,90. Standard-Türstärken Feuerschutz: 39 - 58 mm. Bei Bestellung bitte **immer** angeben. **Kombinierbar mit allen Drückerformen** (Feuerschutz auf Anfrage). **Inkl. Form 1106.**

Schutzbeschlag

Griffplatte/Drücker

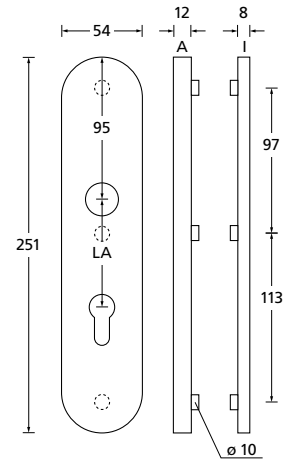

Schutzbeschlag Edelstahl matt

| ES 1 DIN 18257 (SK 2 DIN EN 1906) € exkl. MwSt. | | |
|--------------------------------------------------------|----------|--------|
| PZ - LA 72 mm | 39000ES1 | 137,90 |
| PZ - LA 92 mm | 39001ES1 | 137,90 |

| ÖNORM | | |
|---------------|------------|--------|
| PZ - LA 88 mm | 3900230ES1 | 137,90 |

| Feuerschutz DIN 18273 | | |
|------------------------------|------------|--------|
| PZ - LA 72 mm | 39100ES1FS | 161,90 |

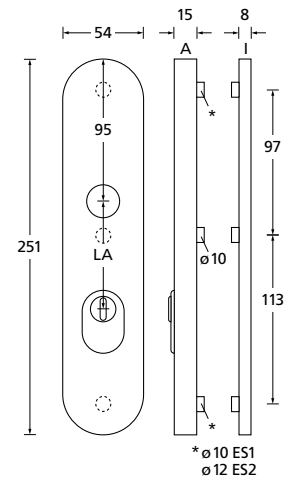

Zylinderüberstand
ES1: 12 - 17 mm
ES2: 11 - 14 mm

Schutzbeschlag mit Kernziehschutz Edelstahl matt

| ES 1 DIN 18257 (SK 2 DIN EN 1906) € exkl. MwSt. | | |
|--------------------------------------------------------|----------|--------|
| PZ - LA 72 mm | 39010ES1 | 151,90 |
| PZ - LA 92 mm | 39011ES1 | 151,90 |

| ES 2 DIN 18257 (SK 3 DIN EN 1906) € exkl. MwSt. | | |
|--------------------------------------------------------|----------|--------|
| PZ - LA 72 mm | 39010ES2 | 175,90 |
| PZ - LA 92 mm | 39011ES2 | 175,90 |

| ÖNORM | | |
|---------------|------------|--------|
| PZ - LA 88 mm | 3901230ES1 | 151,90 |

| ÖNORM | | |
|---------------|------------|--------|
| PZ - LA 88 mm | 3901230ES2 | 175,90 |

| Feuerschutz ÖNORM B 3859 | | |
|---------------------------------|--------------|--------|
| PZ - LA 88 mm | 3911230ES1FS | 173,90 |

| Feuerschutz DIN 18273 | | |
|------------------------------|------------|--------|
| PZ - LA 72 mm | 39110ES2FS | 199,90 |

Standard-Türstärken: 35 - 55 mm, Aufpreis für Türstärken ab 55 mm: € 7,90. Standard-Türstärken Feuerschutz: 39 - 58 mm.
 Bei Bestellung bitte **immer** angeben. **Kombinierbar mit allen Drückerformen** (Feuerschutz auf Anfrage). **Inkl. Form 1106.**



Schutzbeschlag II

Drücker/Drücker

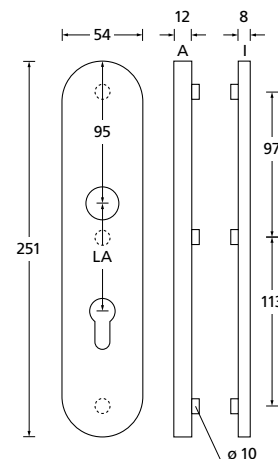

Schutzbeschlag II Edelstahl matt

| ES 1 DIN 18257 (SK 2 DIN EN 1906) € exkl. MwSt. | | |
|-------------------------------------------------|----------|--------|
| PZ - LA 72 mm | 39003ES1 | 107,90 |
| PZ - LA 92 mm | 39004ES1 | 107,90 |
| RZ - LA 78 mm | 39007ES1 | 137,90 |

| ÖNORM | | |
|---------------|------------|--------|
| PZ - LA 88 mm | 3900530ES1 | 107,90 |

| Feuerschutz DIN 18273 | | |
|-----------------------|------------|--------|
| PZ - LA 72 mm | 39003ES1FS | 129,90 |

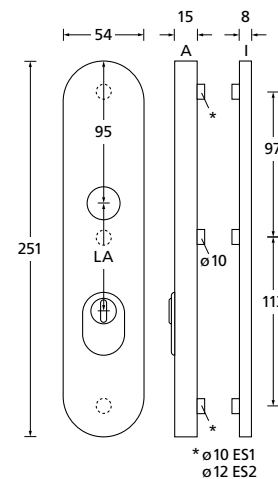

Schutzbeschlag II mit Kernziehschutz Edelstahl matt

| ES 1 DIN 18257 (SK 2 DIN EN 1906) € exkl. MwSt. | | |
|-------------------------------------------------|----------|--------|
| PZ - LA 72 mm | 39013ES1 | 119,90 |
| PZ - LA 92 mm | 39014ES1 | 119,90 |

| ÖNORM | | |
|---------------|------------|--------|
| PZ - LA 88 mm | 3901530ES1 | 119,90 |

| Feuerschutz ÖNORM B 3859 | | |
|--------------------------|--------------|--------|
| PZ - LA 88 mm | 3911530ES1FS | 143,90 |

| Feuerschutz DIN 18273 | | |
|-----------------------|------------|--------|
| PZ - LA 72 mm | 39113ES1FS | 143,90 |

| ES 2 DIN 18257 (SK 3 DIN EN 1906) € exkl. MwSt. | | |
|-------------------------------------------------|----------|--------|
| PZ - LA 72 mm | 39013ES2 | 141,90 |
| PZ - LA 92 mm | 39014ES2 | 141,90 |

| ÖNORM | | |
|---------------|------------|--------|
| PZ - LA 88 mm | 3901530ES2 | 141,90 |

| Feuerschutz DIN 18273 | | |
|-----------------------|------------|--------|
| PZ - LA 72 mm | 39113ES2FS | 165,90 |

Zylinderüberstand
ES 1: 12 - 17 mm
ES 2: 11 - 14 mm

Standard-Türstärken: 35 - 55 mm, Aufpreis für Türstärken ab 55 mm: € 7,90. Standard-Türstärken Feuerschutz: 39 - 58 mm. Bei Bestellung bitte **immer** angeben. **Kombinierbar mit allen Drückerformen** (Feuerschutz auf Anfrage). **Inkl. Form 1106.**

Schutzbeschlag

Griffknopf/Pullbloc® PZ-Halbgarnitur



Schutzbeschlag mit Kernziehschutz Edelstahl matt

SK2 DIN EN 1906 (ES 1 DIN 18257) € exkl. MwSt.
 PZ - LA 72 mm PB39016G 141,90

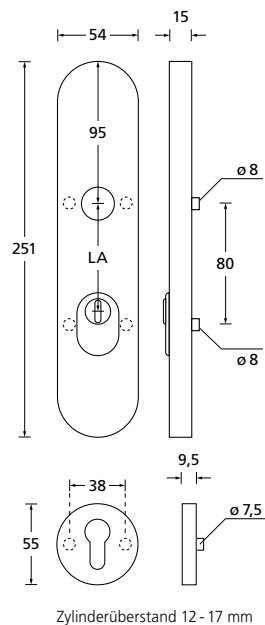

Griffplatte/Pullbloc® PZ-Halbgarnitur



Schutzbeschlag mit Kernziehschutz Edelstahl matt

SK2 DIN EN 1906 (ES 1 DIN 18257) € exkl. MwSt.
 PZ - LA 72 mm PB39016 151,90

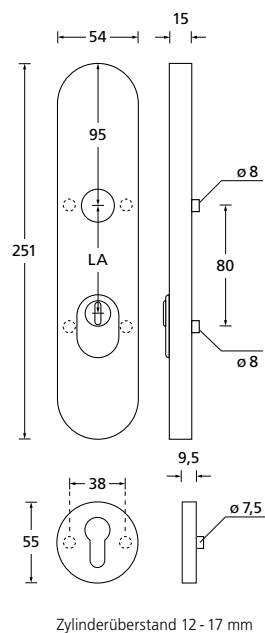

Standard-Türstärken: 35 - 55 mm, Aufpreis für Türstärken ab 55 mm: € 7,90. Bei Bestellung bitte **immer** angeben.
Kombinierbar mit allen Drückerformen. Inkl. Form 1106.



Schutzbeschlag

Zylindrischer Knopf/Pullbloc® PZ-Halbgarnitur

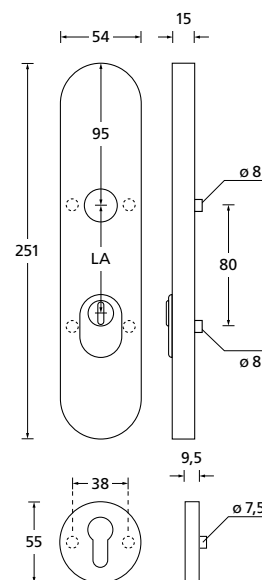

Schutzbeschlag mit Kernziehschutz Edelstahl matt

SK2 DIN EN 1906 (ES 1 DIN 18257) € exkl. MwSt.
PZ - LA 72 mm PB39016K 141,90

Drücker/Pullbloc® PZ-Halbgarnitur

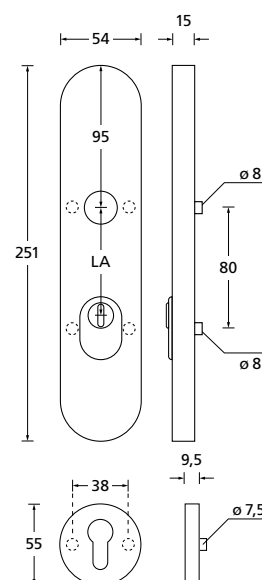

Schutzbeschlag mit Kernziehschutz Edelstahl matt

SK2 DIN EN 1906 (ES 1 DIN 18257) € exkl. MwSt.
PZ - LA 72 mm PB39019 119,90

Standard-Türstärken: 35 - 55 mm, Aufpreis für Türstärken ab 55 mm: € 7,90. Bei Bestellung bitte **immer** angeben.
Kombinierbar mit allen Drückerformen. Inkl. Form 1106.

Schutzbeschlag

Griffknopf/PZ-Halbgarnitur

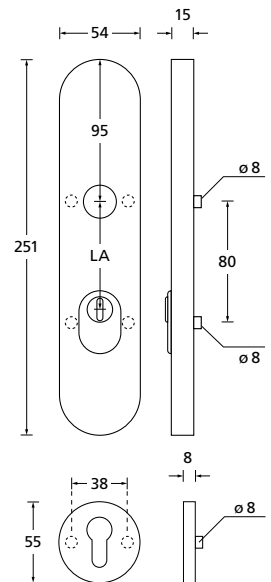

Zylinderüberstand 12-17 mm

Schutzbeschlag mit Kernziehschutz Edelstahl matt

SK2 DIN EN 1906 (ES 1 DIN 18257)

Feuerschutz DIN 18273 € exkl. MwSt.

PZ - LA 72 mm 39116GES1FS 185,90

Griffplatte/PZ-Halbgarnitur

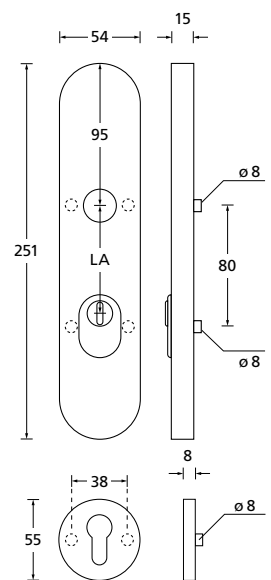

Zylinderüberstand 12-17 mm

Schutzbeschlag mit Kernziehschutz Edelstahl matt

SK2 DIN EN 1906 (ES 1 DIN 18257)

Feuerschutz DIN 18273 € exkl. MwSt.

PZ - LA 72 mm 39116ES1FS 199,90

Standard-Türstärken: 39-58 mm, Aufpreis für Türstärken ab 55 mm: € 7,90. Bei Bestellung bitte **immer** angeben.
Inkl. Drückerformen 1106 (andere Formen auf Anfrage).



Schutzbeschlag

Zylindrischer Knopf/PZ-Halbgarnitur

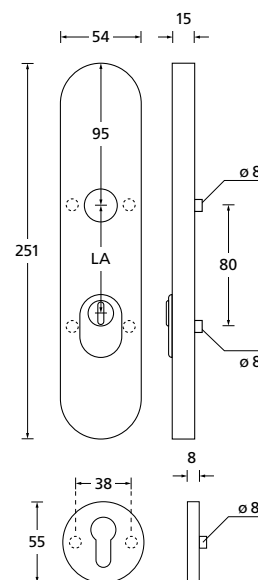

Schutzbeschlag mit Kernziehschutz Edelstahl matt

SK2 DIN EN 1906 (ES 1 DIN 18257)

Feuerschutz DIN 18273 € exkl. MwSt.

PZ - LA 72 mm 39116KES1FS 185,90

Zylinderüberstand 12 - 17 mm

Drücker/PZ-Halbgarnitur

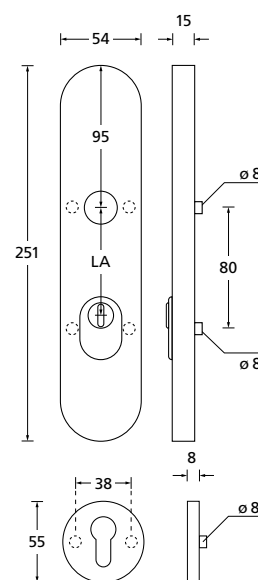

Schutzbeschlag mit Kernziehschutz Edelstahl matt

SK2 DIN EN 1906 (ES 1 DIN 18257)

Feuerschutz DIN 18273 € exkl. MwSt.

PZ - LA 72 mm 39119ES1FS 185,90

Zylinderüberstand 12 - 17 mm

Standard-Türstärken: 39 - 58 mm, Aufpreis für Türstärken ab 55 mm: € 7,90. Bei Bestellung bitte **immer** angeben.
Inkl. Drückerformen 1106 (andere Formen auf Anfrage).

Tresor

Griffplatte/Drücker

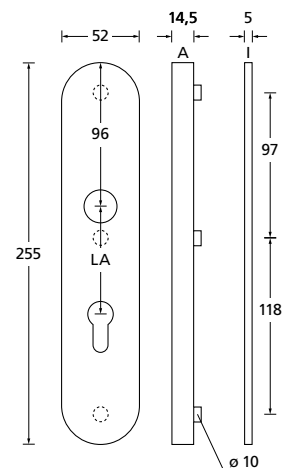

Tresor Edelstahl matt

| | | € exkl. MwSt. |
|---------------|-------|---------------|
| PZ - LA 72 mm | 29000 | 79,90 |
| PZ - LA 92 mm | 29001 | 79,90 |
| PZ - LA 88 mm | 29002 | 79,90 |

318

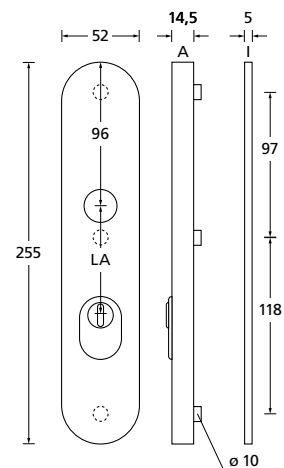

Zylinderüberstand 10 - 15 mm

Tresor mit Kernziehschutz Edelstahl matt

| | | € exkl. MwSt. |
|---------------|-------|---------------|
| PZ - LA 72 mm | 29010 | 99,90 |
| PZ - LA 92 mm | 29011 | 99,90 |
| PZ - LA 88 mm | 29012 | 99,90 |

Standard-Türstärken: 40 - 60 mm. Bei Bestellung bitte **immer** angeben.
Kombinierbar mit allen Drückerformen. Inkl. Form 1106.



Tresor Außenschild

Griffplatte/Pullbloc® PZ-Halbgarnitur



Tresor Edelstahl matt

| | | € exkl. MwSt. |
|---------------------|----------|---------------|
| PZ - LA 72 mm DIN R | PB29006R | 80,90 |
| PZ - LA 72 mm DIN L | PB29006L | 80,90 |
| PZ - LA 92 mm DIN R | PB29007R | 80,90 |
| PZ - LA 92 mm DIN L | PB29007L | 80,90 |
| PZ - LA 88 mm DIN R | PB29008R | 80,90 |
| PZ - LA 88 mm DIN L | PB29008L | 80,90 |

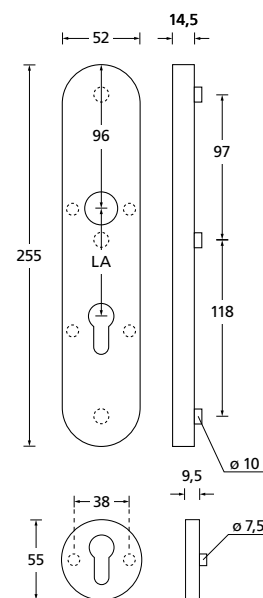

Tresor mit Kernziehschutz Edelstahl matt

| | | € exkl. MwSt. |
|---------------------|----------|---------------|
| PZ - LA 72 mm DIN R | PB29016R | 100,90 |
| PZ - LA 72 mm DIN L | PB29016L | 100,90 |
| PZ - LA 92 mm DIN R | PB29017R | 100,90 |
| PZ - LA 92 mm DIN L | PB29017L | 100,90 |
| PZ - LA 88 mm DIN R | PB29018R | 100,90 |
| PZ - LA 88 mm DIN L | PB29018L | 100,90 |

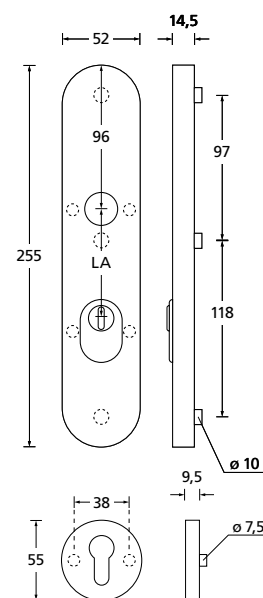

Zylinderüberstand 10 - 15 mm

Tresor

Griffknopf/Drücker

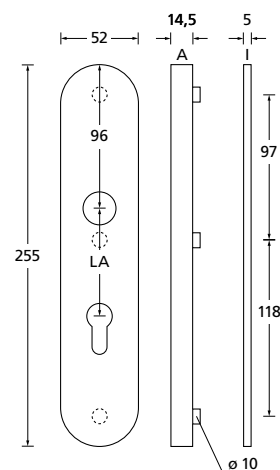

Tresor Edelstahl matt

| | | € exkl. MwSt. |
|---------------|--------|---------------|
| PZ - LA 72 mm | 29000G | 79,90 |
| PZ - LA 92 mm | 29001G | 79,90 |
| PZ - LA 88 mm | 29002G | 79,90 |

320

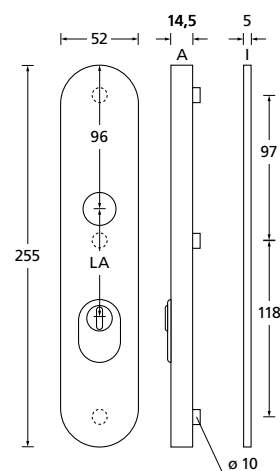

Zylinderüberstand 10 - 15 mm

Tresor mit Kernziehschutz Edelstahl matt

| | | € exkl. MwSt. |
|---------------|--------|---------------|
| PZ - LA 72 mm | 29010G | 99,90 |
| PZ - LA 92 mm | 29011G | 99,90 |
| PZ - LA 88 mm | 29012G | 99,90 |

Standard-Türstärken: 40 - 60 mm. Bei Bestellung bitte **immer** angeben.
Kombinierbar mit allen Drückerformen. Inkl. Form 1106.



Tresor Außenschild

Griffknopf/Pullbloc® PZ-Halbgarnitur



Tresor Edelstahl matt

| | | € exkl. MwSt. |
|---------------------|-----------|---------------|
| PZ - LA 72 mm DIN R | PB29006GR | 80,90 |
| PZ - LA 72 mm DIN L | PB29006GL | 80,90 |
| PZ - LA 92 mm DIN R | PB29007GR | 80,90 |
| PZ - LA 92 mm DIN L | PB29007GL | 80,90 |
| PZ - LA 88 mm DIN R | PB29008GR | 80,90 |
| PZ - LA 88 mm DIN L | PB29008GL | 80,90 |

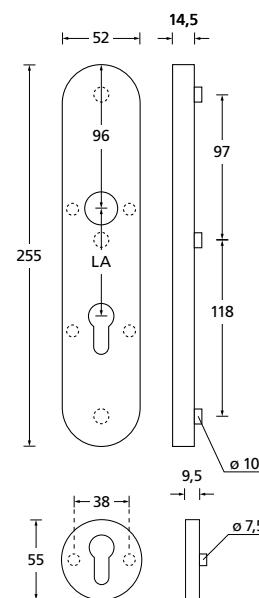

Tresor mit Kernziehschutz Edelstahl matt

| | | € exkl. MwSt. |
|---------------------|-----------|---------------|
| PZ - LA 72 mm DIN R | PB29016GR | 100,90 |
| PZ - LA 72 mm DIN L | PB29016GL | 100,90 |
| PZ - LA 92 mm DIN R | PB29017GR | 100,90 |
| PZ - LA 92 mm DIN L | PB29017GL | 100,90 |
| PZ - LA 88 mm DIN R | PB29018GR | 100,90 |
| PZ - LA 88 mm DIN L | PB29018GL | 100,90 |

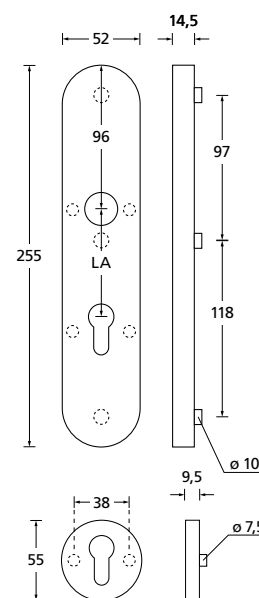

Zylinderüberstand 10 - 15 mm

Tresor II

Drücker/Drücker

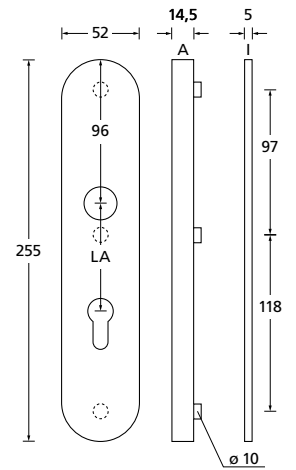

Tresor II Edelstahl matt

| | | € exkl. MwSt. |
|---------------|-------|---------------|
| PZ - LA 72 mm | 29003 | 79,90 |
| PZ - LA 92 mm | 29004 | 79,90 |
| PZ - LA 88 mm | 29005 | 79,90 |

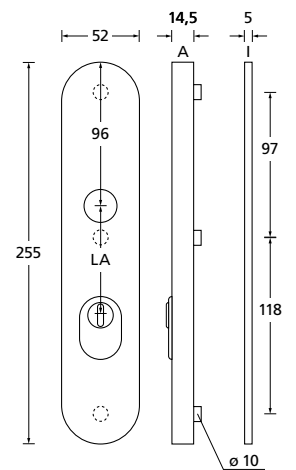

Tresor II mit Kernziehschutz Edelstahl matt

| | | € exkl. MwSt. |
|---------------|-------|---------------|
| PZ - LA 72 mm | 29013 | 99,90 |
| PZ - LA 92 mm | 29014 | 99,90 |
| PZ - LA 88 mm | 29015 | 99,90 |

Zylinderüberstand 10 - 15 mm

Standard-Türstärken: 40 - 60 mm. Bei Bestellung bitte **immer** angeben.
Kombinierbar mit allen Drückerformen. Inkl. Form 1106.



Tresor Außenschild II

Drücker/Pullbloc® PZ-Halbgarnitur

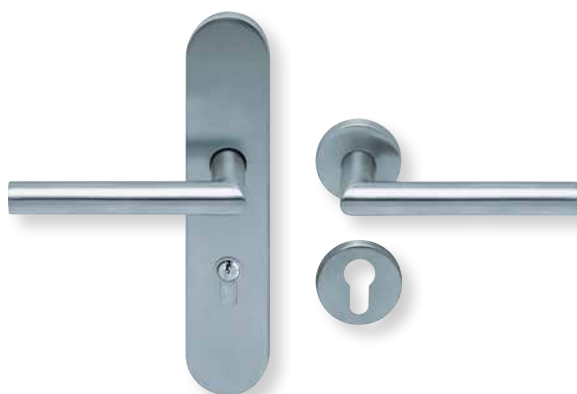

Tresor Außenschild II Edelstahl matt

| | | € exkl. MwSt. |
|---------------------|----------|---------------|
| PZ - LA 72 mm DIN R | PB29009R | 80,90 |
| PZ - LA 72 mm DIN L | PB29009L | 80,90 |
| PZ - LA 92 mm DIN R | PB29030R | 80,90 |
| PZ - LA 92 mm DIN L | PB29030L | 80,90 |
| PZ - LA 88 mm DIN R | PB29031R | 80,90 |
| PZ - LA 88 mm DIN L | PB29031L | 80,90 |

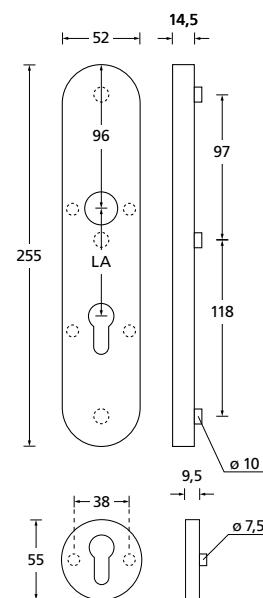

Tresor Außenschild II mit Kernziehschutz Edelstahl matt

| | | € exkl. MwSt. |
|---------------------|----------|---------------|
| PZ - LA 72 mm DIN R | PB29019R | 100,90 |
| PZ - LA 72 mm DIN L | PB29019L | 100,90 |
| PZ - LA 92 mm DIN R | PB29020R | 100,90 |
| PZ - LA 92 mm DIN L | PB29020L | 100,90 |
| PZ - LA 88 mm DIN R | PB29021R | 100,90 |
| PZ - LA 88 mm DIN L | PB29021L | 100,90 |

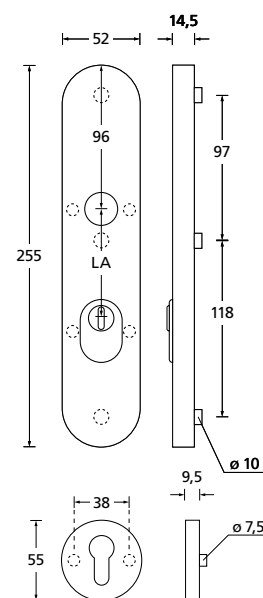

Zylinderüberstand 10 - 15 mm

Sicherheitsrosetten rund



Sicherheitsrosette mit Kernziehschutz
EDELSTAHL matt



Sicherheitsrosette
EDELSTAHL matt



Sicherheitsrosette mit Kernziehschutz
EDELSTAHL poliert



Sicherheitsrosette
EDELSTAHL poliert



Sicherheitsrosette mit Kernziehschutz
PVD Messinggelb



Sicherheitsrosette
PVD Messinggelb

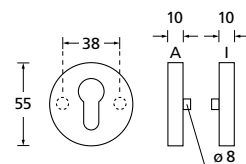
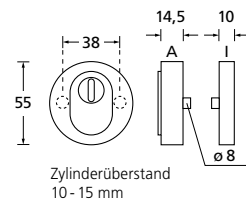

| | Edelstahl matt | | Edelstahl poliert | | PVD Messinggelb | |
|------------------------------|----------------|-------|-------------------|-------|-----------------|-------|
| | € exkl. MwSt. | | € exkl. MwSt. | | € exkl. MwSt. | |
| Sicherheitsrosette PZ | | | | | | |
| inkl. Innenrosette | | | | | | |
| mit Kernziehschutz | 27041 | 43,90 | P27041 | 45,90 | PVM27041 | 47,90 |
| ohne Kernziehschutz | 27040 | 35,90 | P27040 | 37,90 | PVM27040 | 39,90 |
| Sicherheitsrosette RZ | | | | | | |
| inkl. Innenrosette | | | | | | |
| ohne Kernziehschutz | 27042 | 35,90 | | | | |

Standard-Türstärken: 36 - 90 mm



Sicherheitsrosetten quadrat



Sicherheitsrosette mit Kernziehschutz
EDELSTAHL matt



Sicherheitsrosette
EDELSTAHL matt



Sicherheitsrosette mit Kernziehschutz
EDELSTAHL poliert



Sicherheitsrosette
EDELSTAHL poliert



Sicherheitsrosette mit Kernziehschutz
PVD Messinggelb



Sicherheitsrosette
PVD Messinggelb

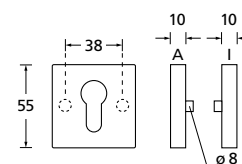
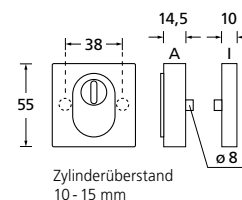

325

| | Edelstahl matt | | Edelstahl poliert | | PVD Messinggelb | |
|------------------------------|----------------|-------|-------------------|-------|-----------------|-------|
| Sicherheitsrosette PZ | € exkl. MwSt. | | € exkl. MwSt. | | € exkl. MwSt. | |
| inkl. Innenrosette | | | | | | |
| mit Kernziehschutz | Q27041 | 49,90 | QP27041 | 51,90 | QPVM27041 | 53,90 |
| ohne Kernziehschutz | Q27040 | 41,90 | QP27040 | 43,90 | QPVM27040 | 45,90 |

Standard-Türstärken: 36-90 mm

Sicherheitsrosetten oval



Sicherheitsrosette mit Kernziehschutz
EDELSTAHL matt



Sicherheitsrosette
EDELSTAHL matt



Sicherheitsrosette mit Kernziehschutz
EDELSTAHL poliert



Sicherheitsrosette
EDELSTAHL poliert

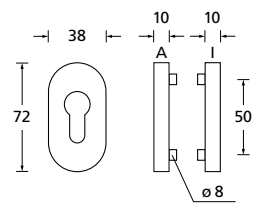
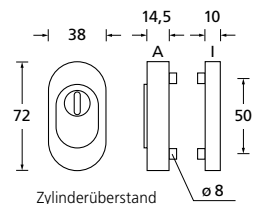

| Sicherheitsrosette PZ | Edelstahl matt | | Edelstahl poliert | |
|--------------------------------------------------|----------------|---------------|-------------------|---------------|
| | | € exkl. MwSt. | | € exkl. MwSt. |
| inkl. Innenrosette mit Kernziehschutz | 27051 | 51,90 | P27051 | 53,90 |
| ohne Kernziehschutz | 27050 | 45,90 | P27050 | 47,90 |
| Sicherheitsrosette PZ | | | | |
| Stück einseitig befestigt ohne Kernziehschutz | 27150 | 25,90 | P27150 | 29,90 |



Sicherheitsrosetten eckig



Sicherheitsrosette mit Kernziehschutz
EDELSTAHL matt



Sicherheitsrosette
EDELSTAHL matt



Sicherheitsrosette mit Kernziehschutz
EDELSTAHL poliert



Sicherheitsrosette
EDELSTAHL poliert

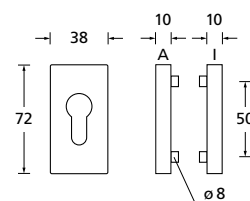
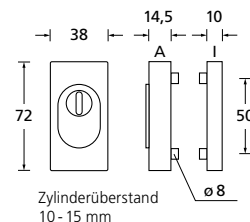

| | Edelstahl matt | | Edelstahl poliert | |
|------------------------------|----------------|-------|-------------------|-------|
| | € exkl. MwSt. | | € exkl. MwSt. | |
| Sicherheitsrosette PZ | | | | |
| inkl. Innenrosette | | | | |
| mit Kernziehschutz | E27051 | 57,90 | EP27051 | 59,90 |
| ohne Kernziehschutz | E27050 | 51,90 | EP27050 | 53,90 |
| Sicherheitsrosette PZ | | | | |
| Stück einseitig befestigt | | | | |
| ohne Kernziehschutz | E27150 | 29,90 | EP27150 | 33,90 |

Standard-Türstärken: 36-90 mm

| | | |
|---------------------------|----|-----|
| Einleitung | ab | 4 |
| Kombinationsmöglichkeiten | ab | 20 |
| Schnellübersicht Formen | ab | 22 |
| Privat- und Objektbau GK3 | ab | 29 |
| Feuerschutzgarnituren | ab | 199 |
| Rosetten/Knöpfe/Schilder | ab | 213 |
| Glastürbeschläge | ab | 249 |
| Fenstergriffe | ab | 275 |
| Sicherheit | ab | 309 |

Stoßgriffe

| | | |
|--------------------------------|----|-----|
| Muschelgriffe | ab | 340 |
| Türstopper | ab | 345 |
| Türfixierer | ab | 347 |
| Hausnummern | ab | 348 |
| Buchstaben und Hinweisschilder | ab | 349 |

Stoßgriffe SG 16 ø 32 / 25

Edelstahl matt

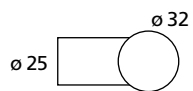

| SG 16 ø 32 / 25 | | € exkl. MwSt. |
|------------------------|--------|---------------|
| | | Stk. |
| ø 32 / BA 300 / GL 400 | 15169 | 27,90 |
| ø 32 / BA 400 / GL 600 | 151610 | 33,90 |



Stoßgriffe SG 16 ø 32 / 25 gekröpft

Edelstahl matt

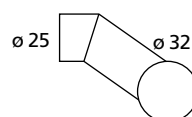

SG 16 ø 32 / 25 gekröpft

€ exkl. MwSt.

| | | Stk. |
|------------------------|--------|-------|
| ø 32 / BA 300 / GL 400 | 25169 | 41,90 |
| ø 32 / BA 350 / GL 500 | 251612 | 45,90 |

Stoßgriffe SG 16 ø 25 / 19

Edelstahl matt

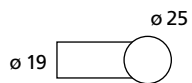

| SG 16 ø 25 / 19 | | € exkl. MwSt. |
|------------------------|--------|---------------|
| | | Stk. |
| ø 25 / BA 200 / GL 400 | 351613 | 25,90 |
| ø 25 / BA 300 / GL 400 | 35169 | 25,90 |
| ø 25 / BA 400 / GL 600 | 351610 | 29,90 |



Stoßgriffe SG 16 ø 25 / 13 eckig Edelstahl matt

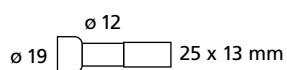

| | |
|----------------------------|---------------|
| SG 16 25 / 13 eckig | € exkl. MwSt. |
| 25/13/BA350/GL600 15163E | Stk. 41,90 |

Stoßgriffe ø 32

Edelstahl matt



| SG 20 32/300 | | € exkl. MwSt. |
|---------------------|-------|---------------|
| | | Stk. |
| ø 32/BA 300 | 15202 | 39,90 |

| SG 04 32/300 | | € exkl. MwSt. |
|---------------------|-------|---------------|
| | | Stk. |
| ø 32/BA 300 | 15042 | 51,90 |

334



| SG 05 32/300 | | € exkl. MwSt. |
|---------------------|-------|---------------|
| | | Stk. |
| ø 32/BA 300 | 15052 | 51,90 |

| SG 07 32/300 | | € exkl. MwSt. |
|---------------------|-------|---------------|
| | | Stk. |
| ø 32/BA 300 | 15072 | 51,90 |

ø = Durchmesser/BA = Bohrabstand



Montage für Stoßgriffe

Edelstahl matt

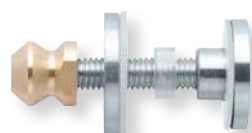

| beidseitig (durchgebohrt) | | € exkl. MwSt. |
|------------------------------------|--------|---------------|
| für alle Türen bis 75 mm Türstärke | 2 Stk. | |
| für SG 16 Ø 32 / 25 | 15103 | 18,30 |
| Bohrung Ø 12 mm | | |
| für SG 16 Ø 25 / 19 | 15108 | 18,30 |
| Bohrung Ø 12 mm | | |
| für Stoßgriffe Ø 32 | 15102 | 18,30 |
| Bohrung Ø 12 mm | | |
| für SG 16 25 / 13 eckig | 15112 | 18,30 |
| Bohrung Ø 12 mm | | |

| einseitig (durchgebohrt) | | € exkl. MwSt. |
|------------------------------------|--------|---------------|
| für alle Türen bis 75 mm Türstärke | 2 Stk. | |
| für SG 16 Ø 32 / 25 | 15101 | 18,30 |
| Bohrung Ø 12 mm | | |
| für SG 16 Ø 25 / 19 | 15109 | 18,30 |
| Bohrung Ø 12 mm | | |
| für Stoßgriffe Ø 32 | 15100 | 18,30 |
| Bohrung Ø 12 mm | | |
| für SG 16 25 / 13 eckig | 15113 | 18,30 |
| Bohrung Ø 12 mm | | |

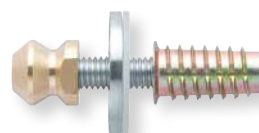
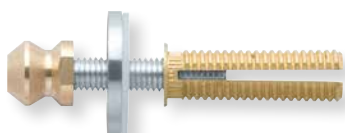

| einseitig (unsichtbar) | | € exkl. MwSt. |
|-------------------------------|--------|---------------|
| für Hohltüren | 2 Stk. | |
| für SG 16 Ø 32 / 25 | 15105 | 18,30 |
| Bohrung Ø 11 mm | | |
| für SG 16 Ø 25 / 19 | 15110 | 18,30 |
| Bohrung Ø 8 - 9 mm | | |
| für Stoßgriffe Ø 32 | 15107 | 18,30 |
| Bohrung Ø 11 mm | | |

| einseitig (unsichtbar) | | € exkl. MwSt. |
|-------------------------------|--------|---------------|
| für Holz- und Kunststofftüren | 2 Stk. | |
| für SG 16 Ø 32 / 25 | 15104 | 18,30 |
| Bohrung Ø 10 mm | | |
| für SG 16 Ø 25 / 19 | 15111 | 18,30 |
| Bohrung Ø 7,5 - 8 mm | | |
| für Stoßgriffe Ø 32 | 15106 | 18,30 |
| Bohrung Ø 10 mm | | |

Stoßgriffe nach Maß

Edelstahl matt

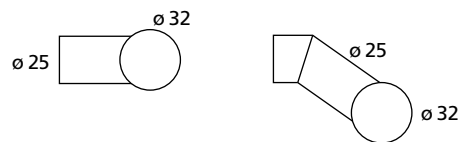
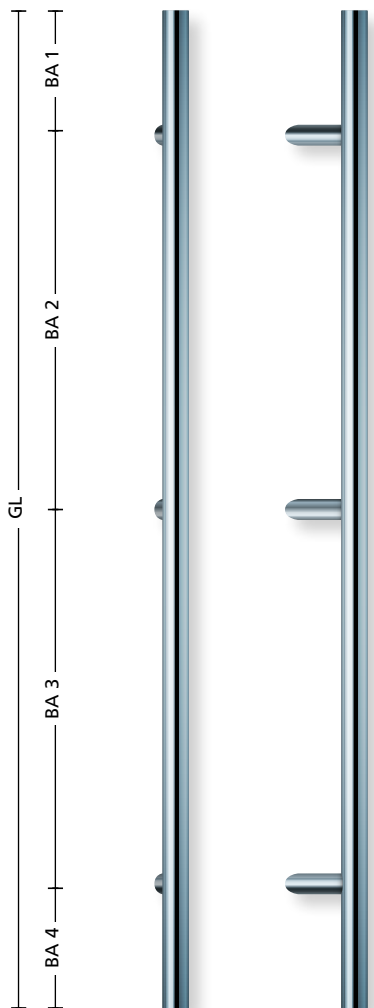

| Stützen | | € exkl. MwSt. |
|----------|-------|---------------|
| gerade | 55001 | 17,90 |
| gekröpft | 55002 | 17,90 |

Es werden mindestens zwei Stützen benötigt.
Der maximale Abstand zwischen den Stützen beträgt 700 mm.

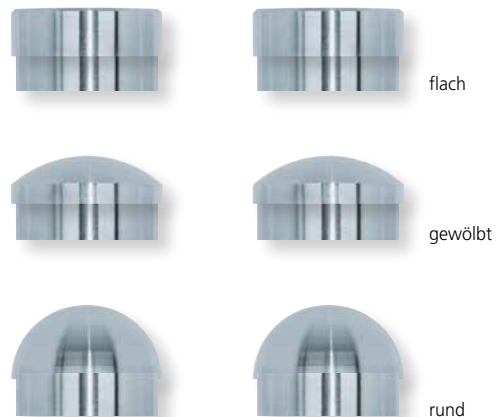

| Griffstangenrohr \varnothing 32 | | € exkl. MwSt. |
|-----------------------------------|-------|---------------|
| pro 1 mm | 55000 | 0,16 |

(bei Bestellung immer gewünschte Länge angeben)

| Abschlusskappen | | € exkl. MwSt. |
|-----------------|-------|---------------|
| flach | 55003 | 19,90 |
| gewölbt | 55005 | 19,90 |
| rund | 55004 | 19,90 |

\varnothing = Durchmesser / BA = Bohrabstand / GL = Gesamtlänge inkl. Abschlusskappen



Bestellhilfe zum Kopieren

Stoßgriff mit **2 Stützen**

Stoßgriff mit **3 Stützen**

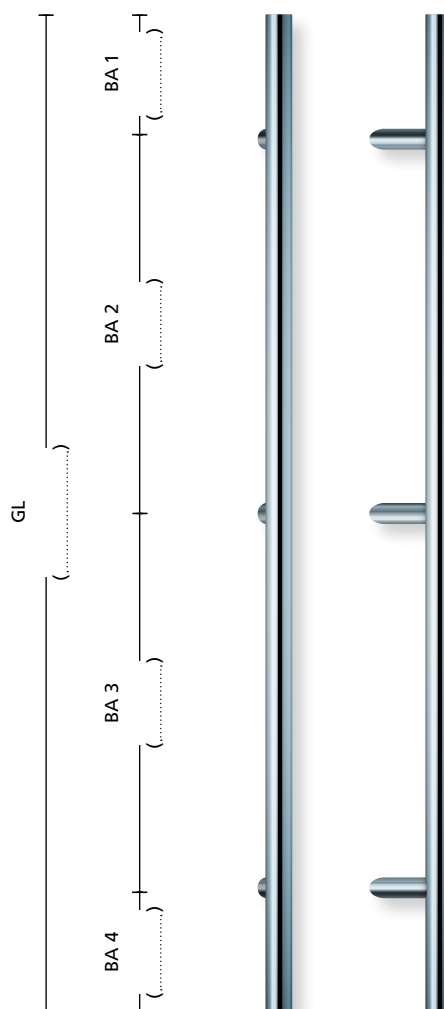
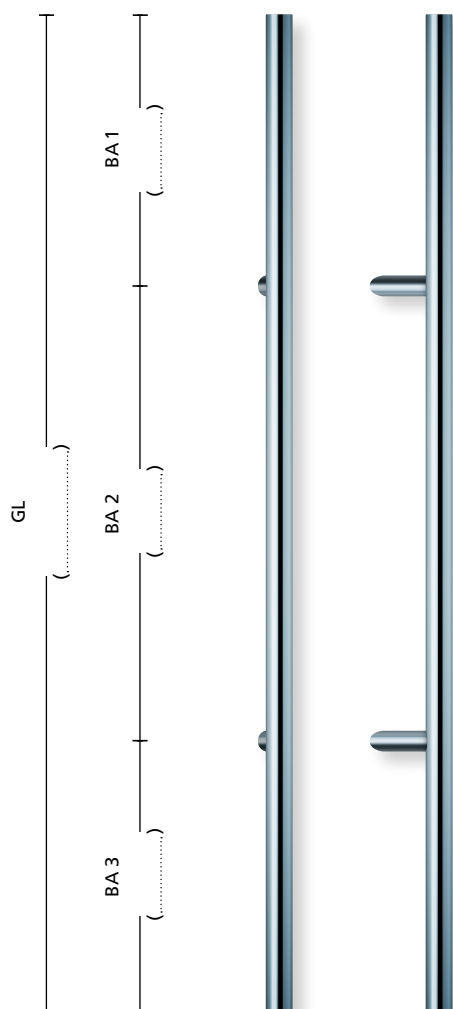

Stützen Zutreffendes bitte ankreuzen

gerade

gekröpft

Abschlusskappen Zutreffendes bitte ankreuzen

flach

gewölbt

rund

∅ = Durchmesser / BA = Bohrabstand / GL = Gesamtlänge inkl. Abschlusskappen

| | | |
|---------------------------|----|-----|
| Einleitung | ab | 4 |
| Kombinationsmöglichkeiten | ab | 20 |
| Schnellübersicht Formen | ab | 22 |
| Privat- und Objektbau GK3 | ab | 29 |
| Feuerschutzgarnituren | ab | 199 |
| Rosetten/Knöpfe/Schilder | ab | 213 |
| Glastürbeschläge | ab | 249 |
| Fenstergriffe | ab | 275 |
| Sicherheit | ab | 309 |
| Stoßgriffe | ab | 329 |

Muschelgriffe

Türstopper

Türfixierer

Hausnummern

Buchstaben und Hinweisschilder

Muschelgriffe

Edelstahl matt

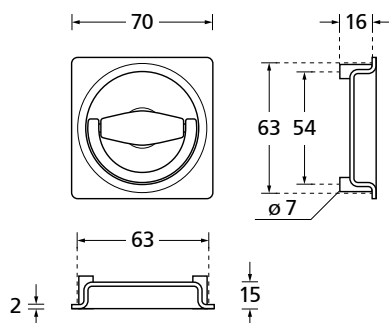
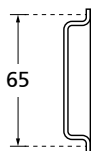
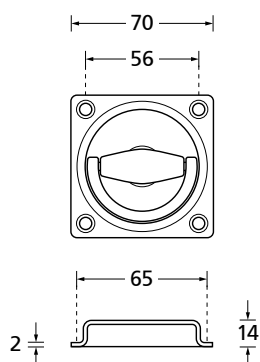

| | | |
|-------------------------|-------|---------------|
| Klappringmuschel | | € exkl. MwSt. |
| Vierkant 7/8 mm | | |
| Klappringmuschel | 90170 | 31,90 |

| | | |
|------------------------------------------|-------|---------------|
| Klappringmuschel | | € exkl. MwSt. |
| Vierkant 7/8 mm | | |
| Klappringmuschel mit vier M4-Stütznocken | 90171 | 31,90 |

340

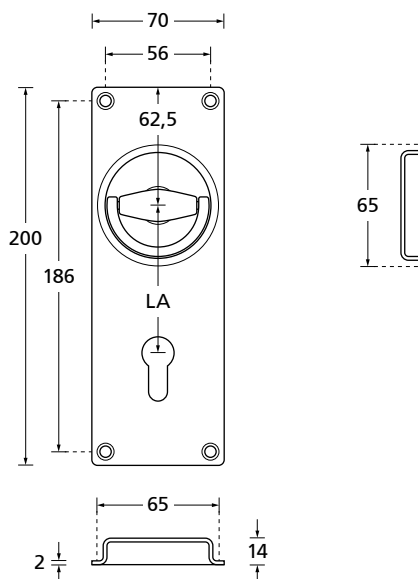

| | | |
|-----------------------------------|-------|---------------|
| Klappringmuschel | | € exkl. MwSt. |
| Vierkant 8 mm | | |
| PZ - LA 78 mm | 90160 | 49,90 |
| (andere Lochabstände auf Anfrage) | | |
| Blind | 90161 | 49,90 |



Muschelgriffe

Edelstahl matt

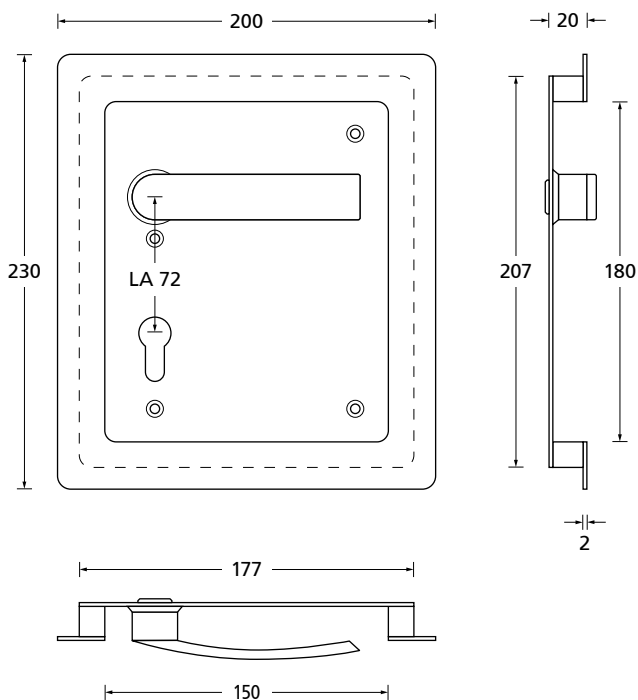

| Sporthallenmuschel | | € exkl. MwSt. |
|---------------------------|-------|---------------|
| Vierkant 9 mm | | |
| PZ - LA 72 mm DIN R | 90360 | 119,90 |
| PZ - LA 72 mm DIN L | 90361 | 119,90 |
| Blind - DIN R | 90460 | 119,90 |
| Blind - DIN L | 90461 | 119,90 |

Schiebetürmuscheln

Edelstahl

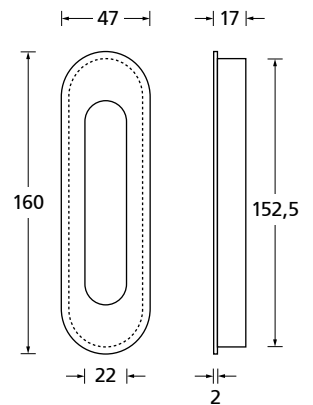
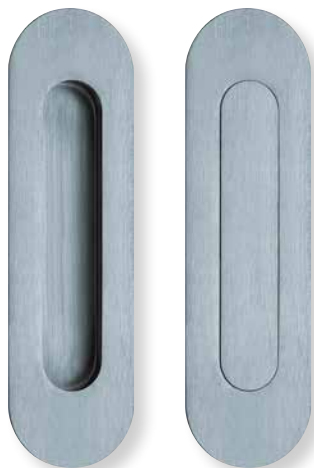

Edelstahl matt

| Schiebetürmuschel | | € exkl. MwSt. |
|-------------------|--------|---------------|
| oval offen | 200381 | 21,90 |
| oval geschlossen | 20038 | 25,90 |

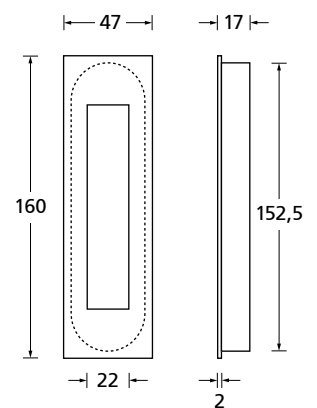
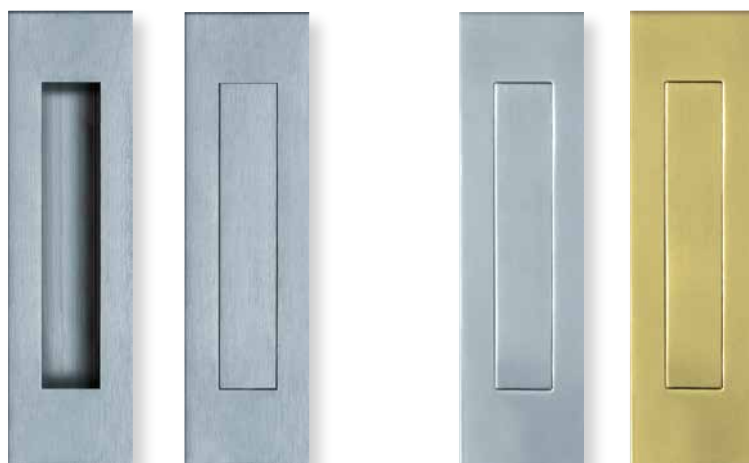

Edelstahl matt

| Schiebetürmuschel | | € exkl. MwSt. |
|------------------------|--------|---------------|
| rechteckig offen | 200411 | 25,90 |
| rechteckig geschlossen | 20041 | 29,90 |

Edelstahl poliert

| Schiebetürmuschel | | € exkl. MwSt. |
|------------------------|--------|---------------|
| rechteckig geschlossen | P20041 | 38,90 |

PVD Messinggelb

| Schiebetürmuschel | | € exkl. MwSt. |
|------------------------|----------|---------------|
| rechteckig geschlossen | PVM20041 | 49,90 |



Schiebetürmuscheln Edelstahl

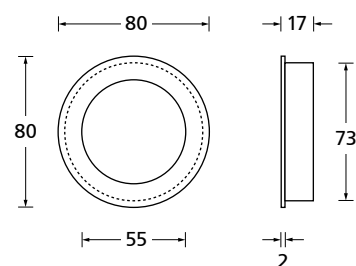

Edelstahl matt

| | | |
|--------------------------|-------|---------------|
| Schiebetürmuschel | | € exkl. MwSt. |
| rund geschlossen | 20039 | 19,90 |

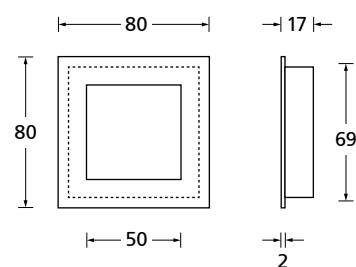
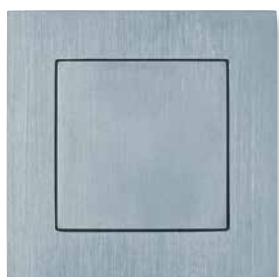

Edelstahl matt

| | | |
|--------------------------|-------|---------------|
| Schiebetürmuschel | | € exkl. MwSt. |
| quadratisch geschlossen | 20040 | 23,90 |

Schiebetürmuscheln

Edelstahl

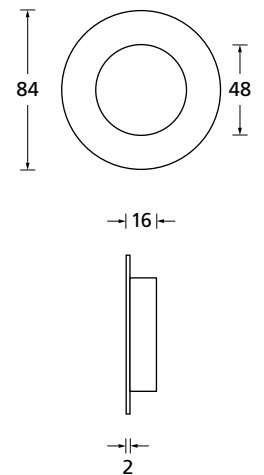

Edelstahl matt

| Schiebetürmuschel | | € | exkl. MwSt. |
|------------------------------|-------|-------|-------------|
| rund | 20031 | 15,90 | |
| rund unsichtbare Befestigung | 20034 | 15,90 | |

Edelstahl poliert

| Schiebetürmuschel | | € | exkl. MwSt. |
|------------------------------|--------|-------|-------------|
| rund | P20031 | 17,90 | |
| rund unsichtbare Befestigung | P20034 | 17,90 | |

344

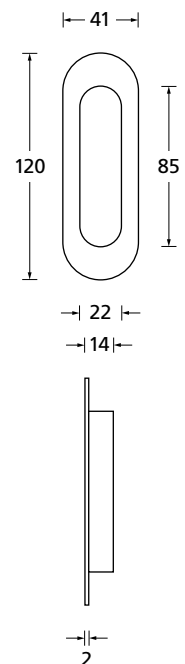
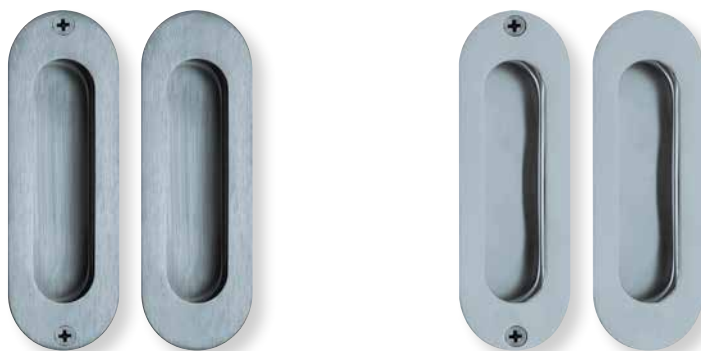

Edelstahl matt

| Schiebetürmuschel | | € | exkl. MwSt. |
|------------------------------|-------|-------|-------------|
| oval | 20030 | 15,90 | |
| oval unsichtbare Befestigung | 20032 | 15,90 | |

Edelstahl poliert

| Schiebetürmuschel | | € | exkl. MwSt. |
|------------------------------|--------|-------|-------------|
| oval | P20030 | 17,90 | |
| oval unsichtbare Befestigung | P20032 | 17,90 | |



Türstopper Edelstahl matt

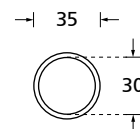
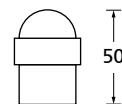

Türstopper rund TS 20 € exkl. MwSt.
H 50/ø 30 mm 20020 14,90

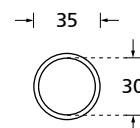
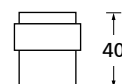

Türstopper flach TS 21 € exkl. MwSt.
H 40/ø 30 mm 20021 14,90

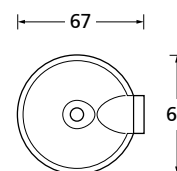
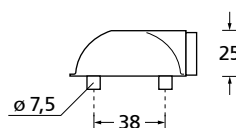

Türstopper Schildkröte TS 23 € exkl. MwSt.
H 25/L 67/B 65 mm 20023 17,90

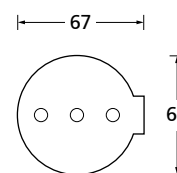
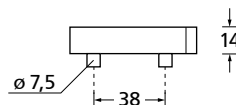

Gummi-Unterlegplatte € exkl. MwSt.
für Türstopper Schildkröte TS 23
H 14/L 67/B 65 mm 200231 3,00

Türstopper

Edelstahl matt

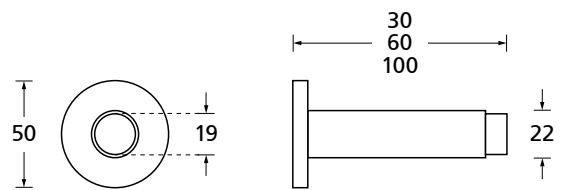

| Wandtürstopper TS 22 | | € exkl. MwSt. |
|-----------------------------|----------|---------------|
| L 100/ø 22 mm | 20022 | 17,90 |
| L 30/ø 22 mm | 20022/30 | 13,90 |
| L 60/ø 22 mm | 20022/60 | 15,90 |

346

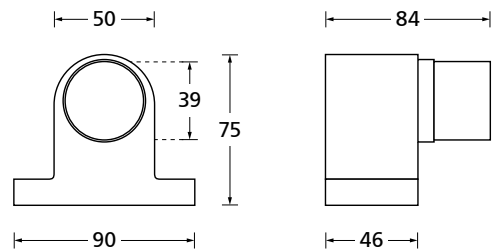

| Türst. Edelstahl mit Feder TS 35 | | € exkl. MwSt. |
|-----------------------------------------|-------|---------------|
| Edelstahl H 75/L 84/B 90/46 mm | | |
| Gummi ø 39 mm | 20035 | 29,90 |



Türfixierer

Edelstahl matt

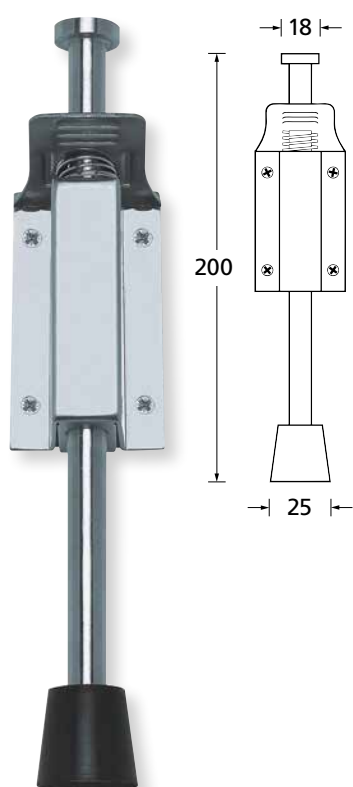

Türfixierer TF 04 € exkl. MwSt.
Hub 40 mm 20024 17,90

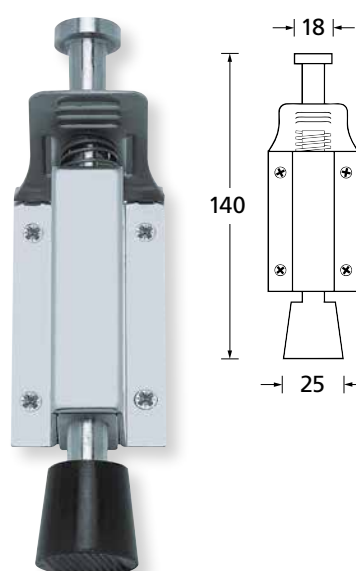

Türfixierer TF 05 € exkl. MwSt.
Hub 40 mm 20025 17,90

Hausnummern

Edelstahl matt

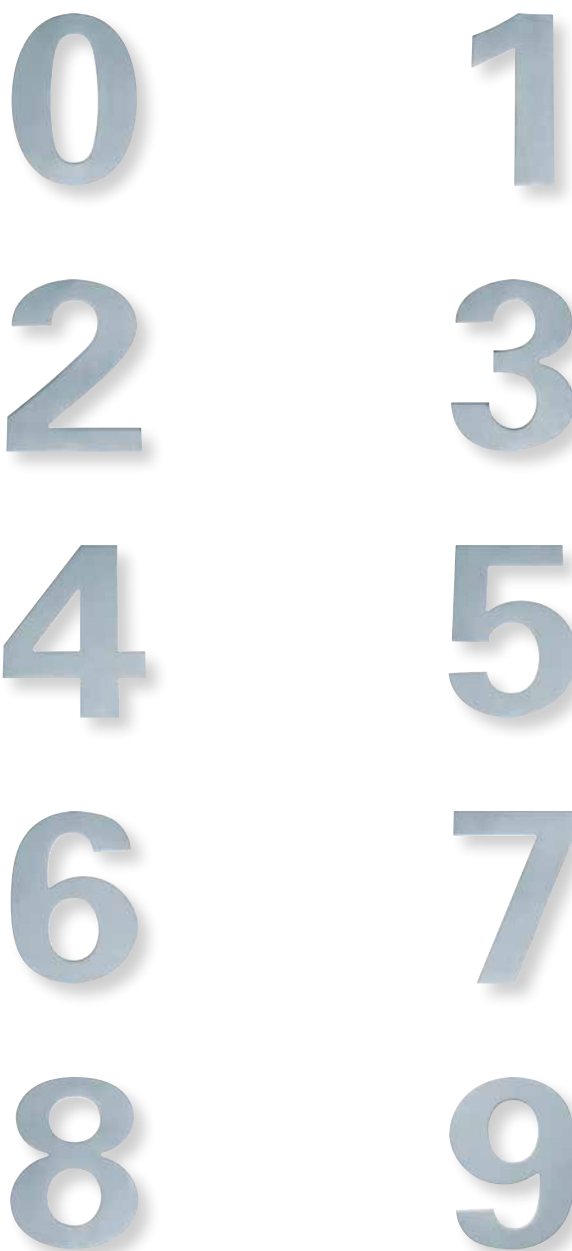

| H 150 mm | | € exkl. MwSt. |
|----------------------|-------|----------------------|
| Hausnummer „0“ | 13000 | 15,90 |
| Hausnummer „1“ | 13001 | 15,90 |
| Hausnummer „2“ | 13002 | 15,90 |
| Hausnummer „3“ | 13003 | 15,90 |
| Hausnummer „4“ | 13004 | 15,90 |
| Hausnummer „5“ | 13005 | 15,90 |
| Hausnummer „6“ / „9“ | 13006 | 15,90 |
| Hausnummer „7“ | 13007 | 15,90 |
| Hausnummer „8“ | 13008 | 15,90 |



Buchstaben und Hinweisschilder Edelstahl matt

a



b



c



d



| b, d=H 150 mm / a, c=H 115 mm | | € exkl. MwSt. |
|--------------------------------------|-------|---------------|
| Buchstabe „a“ | 13009 | 15,90 |
| Buchstabe „b“ | 13010 | 15,90 |
| Buchstabe „c“ | 13011 | 15,90 |
| Buchstabe „d“ | 13012 | 15,90 |

| ø 75 mm | | € exkl. MwSt. |
|----------------|-------|---------------|
| Damen | 20010 | 9,90 |
| Herren | 20011 | 9,90 |
| WC | 20014 | 9,90 |
| Handicap | 20012 | 9,90 |
| Nichtraucher | 20013 | 9,90 |



scoop Beschlage Vertriebs-GmbH
Kaltenbrunn 22
D-83413 Fridolfing
Fon: +49 8684 96967-0
Fax: +49 8684 96967-29
info@scoop-tec.de
www.scoop-tec.de

scoop®, Pullbloc®, Pullbloc® 3.0, Pullbloc® 4.1, Slidebloc®, Slidebloc® 3.0, Slidebloc® 4.0, Slidebloc® light und formspiele® sind eingetragene Marken der scoop Beschlage Vertriebs-GmbH. Die in diesem Katalog enthaltenen Beschreibungen und Abbildungen entsprechen dem Zeitpunkt der Drucklegung. Fur Druck- oder Satzfehler wird keine Haftung ubernommen.

Unsere Allgemeinen Geschaftsbedingungen finden Sie unter www.scoop-tec.de. Alle Rechte behalten wir uns vor.

© copyright: scoop Beschlage Vertriebs-GmbH. Gedruckt im April 2020.

